

*LINEAR PHONE BOOTH
LINEAR STUDIO*

*SAFETY AND INSTALLATION
INSTRUCTIONS*



Oasis Berco Installation, Operating & Safety Instructions

Linear & Soft Phone Booth(s)

- All Oasis Berco products are intended for commercial use.
- Please note that specific installation drawings and instructions are provided at the end of this document.
- **WARNING Risk of injury – Maximum Load on Phone Booth Work Surface is 10 pounds**
- DRY LOCATIONS ONLY

IMPORTANT SAFETY INSTRUCTIONS

When using an electrical furnishing, basic precautions should always be followed, including the following: Read all instructions before using this Oasis Berco furnishing.

WARNING: Risk of Electric Shock, Fire, and Injury. Review the assembly instructions to confirm that the appropriate critical components and accessories are being used with the furnishing.

DANGER – To reduce the risk of electric shock:

1. Always unplug this furnishing from the electrical outlet before cleaning.

WARNING – To reduce the risk of burns, fire, electric shock, or injury to persons:

1. Unplug from outlet before putting on or taking off parts.
2. Close supervision is necessary when this furnishing is used by, or near children, invalids, or disabled persons.
3. Use this furnishing only for its intended use as described in these instructions. Do not use attachments not recommended by the manufacturer.
4. Never operate this furnishing if it has a damaged cord or plug, if it is not working properly, if it has been dropped or damaged, or dropped into water. Return the furnishing to a service center for examination and repair.
5. Keep the cord away from heated surfaces.
6. Never operate the furnishing with the air openings blocked. Keep the air openings free of lint, hair, and the like.
7. Never drop or insert any object into any opening.
8. Do not use outdoors.
9. Do not operate where aerosol (spray) products are being used or where oxygen is being administered.
10. **WARNING: Risk of Electric Shock** – Connect this furnishing to a properly grounded outlet only. See Grounding Instructions below.
11. For loading always put heavier items at the bottom and not near the top in order to help prevent the possibility of the furnishing tipping over.
12. **WARNING Risk of injury** – Maximum Load on Phone Booth Work Surface is 10 pounds.
13. Mount furnishings at the correct height.

SAVE THESE INSTRUCTIONS

Tools needed for assembly:

- #2 Phillips Bit/Screwdriver
- 3.5MM Allen Wrench
- Lint Roller
- White Gloves

Hardware/Accessory Kit:

- 4 - #8 x ¾" Wood Screw
 - 6 - #8 x 1 ½" Wood Screw
 - 24 - ¼ - 20 x 2" Bolt
 - 24 - ¼ Fender Washer
 - 1 - Plastic Fan Cover
 - "V" Seal
- Optional work surface hardware*
- 4 - ¼ - 20 x 1" Flat Head Bolt
 - 6 - #10 x 1" Wood Screw

Before you start:

1. Read instructions and check that all parts are accounted for before you start building.
2. Begin assembly as close to final product location as possible.
3. Additional assembly instructions may be required depending on specification of product ordered.
4. Read all Operating & Safety instructions before using this Oasis Berco furnishing.



Step 1

- A. White gloves are recommended during installation to avoid dirt or grease transfer to the Oasis unit.
- B. Start the booth assembly with the rear wall pre fitted with the corner posts & the power managed side wall. (power wall goes on left side for LH door unit and right side for RH door). *Note: if you have a glass rear wall, the installation is the same as a non-glass rear wall – see image on next page.*
- C. Secure walls together using 8 - ¼" - 20 x 2" bolts & 8 - ¼" fender washers from the hardware kit. You will use 4 bolts and washers from each side of the back left corner.
- D. Make sure the panels line up at the top.

Tools needed for assembly:

- #2 Phillips Bit/Screwdriver
- 3.5MM Allen Wrench
- Lint Roller
- White Gloves

Hardware/Accessory Kit:

- 4 - #8 x ¾" Wood Screw
 - 6 - #8 x 1 ½" Wood Screw
 - 24 - ¼ - 20 x 2" Bolt
 - 24 - ¼ Fender Washer
 - 1 - Plastic Fan Cover
 - "V" Seal
- Optional work surface hardware*
- 4 - ¼ - 20 x 1" Flat Head Bolt
 - 6 - #10 x 1" Wood Screw

Before you start:

1. Read instructions and check that all parts are accounted for before you start building.
2. Begin assembly as close to final product location as possible.
3. Additional assembly instructions may be required depending on specification of product ordered.
4. Read all Operating & Safety instructions before using this Oasis Berco furnishing.

Step 1



- A. White gloves are recommended during installation to avoid dirt or grease transfer to the Oasis unit.
- B. Start the booth assembly with the rear wall pre fitted with the corner posts & the power managed side wall. (power wall goes on left side for LH door unit and right side for RH door). *Note: if you have a glass rear wall, the installation is the same as a non-glass rear wall – reference picture above.*
- C. Secure walls together using 8 - ¼" - 20 x 2" bolts & 8 - ¼" fender washers from the hardware kit. You will use 4 bolts and washers from each side of the back left corner.
- D. Make sure the panels line up at the top.

Step 2



- A. Add the right hand wall.
- B. Secure walls together using 8 - ¼" - 20 x 2" bolts & 8 - ¼" fender washers from the hardware kit. You will use 4 bolts and washers from each side of the back right corner.
- C. Make sure the panels line up at the top.

Step 3



- A. Add the door section. *Note: if you are installing a Studio, the door/side glass assembly ships assembled, so the instructions are exactly the same.*
- B. Secure walls to door using 8 - ¼" - 20 x 2" bolts & 8 - ¼" fender washers from the hardware kit (4 bolts and washers on each side of the door frame).
- C. Make sure the panels line up at the top.
- D. Use Allen wrench to adjust the glides in each of the 4 corners to level the unit.
- E. Test door to make sure it is level and closes appropriately. If the door does not close properly, adjust the floor glides to square up the door. You will be able to adjust closing speed in the final step.

Step 4

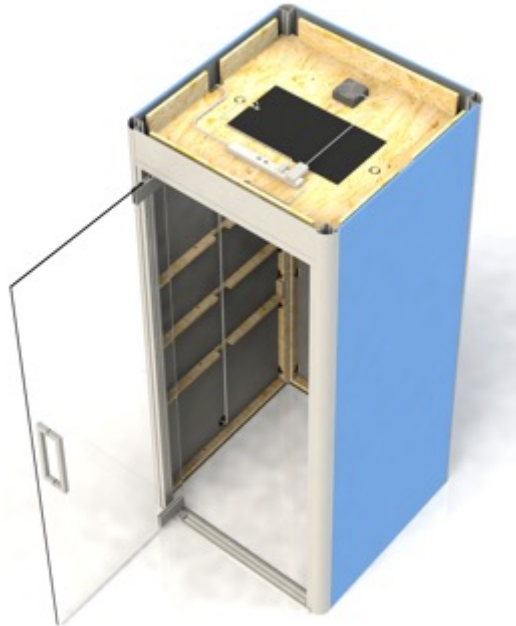

- A. The ceiling panel is supplied with the electrical pre-installed.
- B. Lift the ceiling panel into position from the top with the fan unit to the rear of the booth. Before you set it in place, make sure the cords mentioned in "C" and "D" below are hanging into the unit.
- C. Drop the power cable down the inside of the booth and through the cable outlet so it exits out the base of the unit. The power cord will run down the left side of the unit with a left hand door (as pictured above) or the right side of the unit with a right hand door.
- D. Drop the motion sensor down the front corner of the booth closest to the hinge side of the door. This will be attached after the acoustical panels are installed.
- E. If an optional work surface with integrated power is included, drop the extension cord down the inside of the booth in the same area of the power cable. This extension cord will be connected to the work surface power later in the installation.
- F. Connect the power and make sure the light & fan turn off/on via the sensor (the light intensity and fan speed can be changed by adjusting the dials on the ceiling panel).
 - i. If the light and fan do not work, first check all connections on the ceiling panel.
 - ii. Reset the motion sensor (See Step 9, E).
 - iii. See Electrical Troubleshoot section at the end of this document.
 - iv. If all connections are secure, please contact Oasis Berco Customer Service at 314-222-0757
- G. Secure the ceiling panel using 6 - #8 x 1 1/2" wood screws from the hardware kit. Evenly space 2 screws on each side wall and the back wall.

Step 5

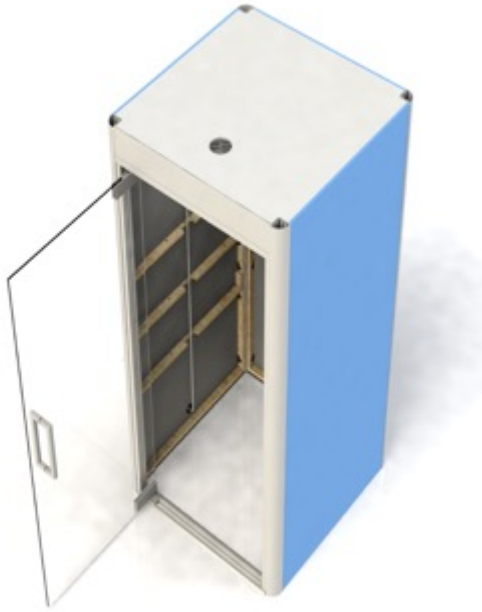

- A. To finish the ceiling lift the white ceiling cover into position with the air inlet towards the front of the booth.
- B. Attach the fan cover over the air inlet and secure with 4 - #8 x 3/4" wood screws from the hardware kit.

Step 6



- A. Install the internal fabric panels. Both full size panels are interchangeable so it does not matter which you use for the rear and side wall.
- B. Start with the rear panel. Lift into the booth, line up with frame & push into place making contact with the 4 clips on each side.
- C. Next install the side panel opposite the electrical service wall. Lift into booth, line up with frame & push in place making contact with the 4 clips on each side.

Step 7



- A. Install the bottom panel on the service wall. Push into place like other panels.
- B. If you have an optional work surface, it can be installed at either seated or standing height. (the image shows the shelf at standing height)
- C. Screw the shelf brackets to the LH wall using 4 - $\frac{1}{4}$ " - 20 x 1" flat head bolts from the hardware kit.
- D. Install the next 2 panels from bottom up.
 - i. If you installed shelf brackets, there will be a panel with notches cut around the shelf brackets.
 - ii. If there is integrated power in the work surface, there will be a grommet in the panel. The panel should be installed with the grommet just under the location of the shelf brackets so it will be hidden by the work surface.
- E. If provided, install the integrated electrical outlet into the work surface per the directions provided with the electrical outlet.
- F. Push the end of the cord from the electrical outlet through the grommet and connect to the end of the extension cord in the service wall.

Step 8



- A. Install the work surface using 6 - #10 x 1" wood screws from the hardware kit
 - A. **NOTE: MAXIMUM WEIGHT LOAD ON THE WORK SURFACE IS 10 LBS**
- B. Push any extra cord from the integrated electrical outlet into the service wall
- C. Install the final interior panel by pushing in place like other panels.

Step 9



- A. Test the door again to make sure the closing speed is working properly. If the door needs adjustment, see instructions at the end of this document.
- B. Install "V" seal door gasket on both sides of the door frame. On the door handle side, install inside the booth. On the hinge side, install outside the booth. See picture below.
- C. Give the booth a final clean on the all painted profiles, glass & work surface.
- D. Remove the film covering that is protecting the threshold.
- E. Use a lint roller on the fabric panels to remove any handling marks.
- F. Adjust the motion sensor as follows:
 - i. Press and hold the button on the side for 5 seconds until the red LED illuminates. Then press:
 - a. Twice for 10 minutes
 - b. Three times for 30 minutes
 - c. Four times for 60 minutes
 - ii. After the countdown timer is set, the LED will flash the same number of times the button was pressed to confirm the new timer setting.
- G. Secure the motion sensor to the interior top corner by using the double stick tape provided on the back of the sensor.



Interior "V" Seal



Exterior "V" Seal

DOOR CLOSING SPEED ADJUSTMENT

DOOR ADJUSTMENT

8. Adjust the closing speed. (Fig. 10)

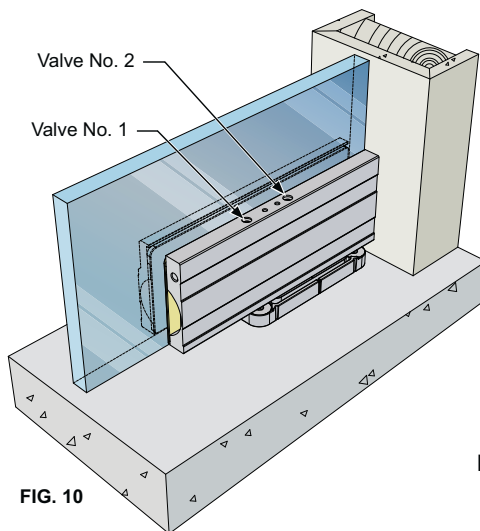

FIG. 10

Adjustment of closing speed:

- Two regulating valves (No. 1) and (No. 2)

- ↻ Decrease closing speed

- ↻ Increase closing speed

- Valve (No. 1): Control closing range 170° to 15°

- Valve (No. 2): Control closing range 15° to 0°

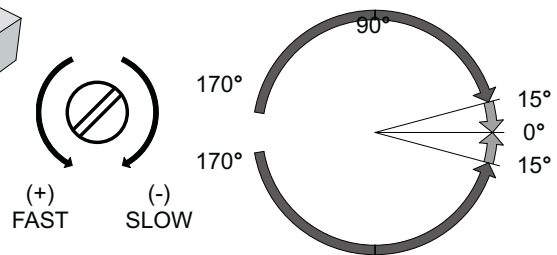

ELECTRICAL TROUBLESHOOTING

(Page 1 of 2)

Step 1

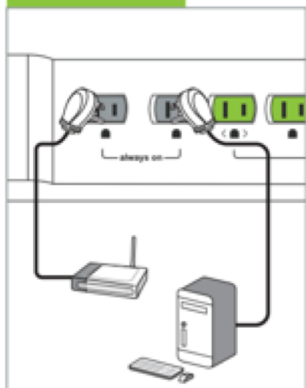

Plug in devices that require continuous power into the always-on outlets (e.g., modem, CPU).

Step 2

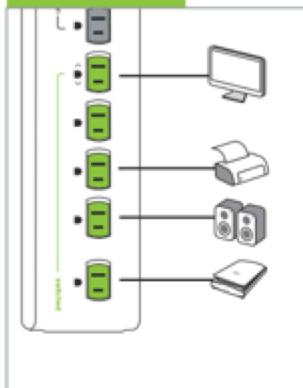

Plug peripheral electronics into the outlets on the power strip labeled "switched".

Step 3

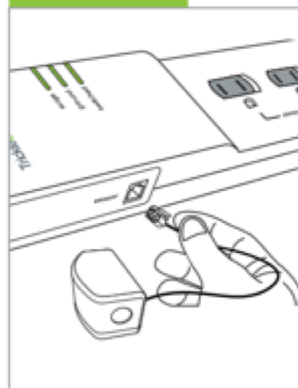

Plug the SensorClick motion sensor into the port on the side of the power strip that looks like a phone jack and is marked "sensor".

Step 4

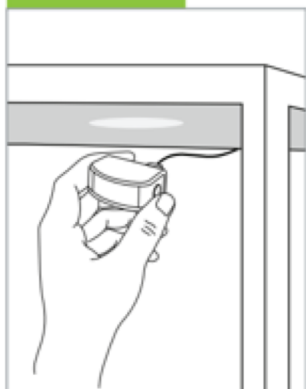

Mount the motion sensor to a flat surface (e.g., under the desk) aiming at the area you wish to detect movement.

Step 5

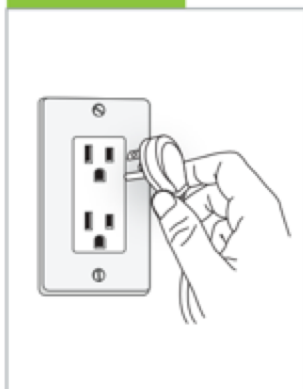

Plug the power strip into a grounded outlet receptacle. The ground and surge lights on the power strip will illuminate indicating that the power strip is properly grounded, and that surge protection is active.



Important: The product must only be plugged into a grounded outlet receptacle. All connected electronics should be plugged directly into the product. Use of an extension cord, adaptor, or any power strip in conjunction with the Product will void all warranties.

ELECTRICAL TROUBLESHOOTING (Page 2 of 2)

The SensorClick motion sensor has a configurable countdown timer that has a default setting of 30 minutes.

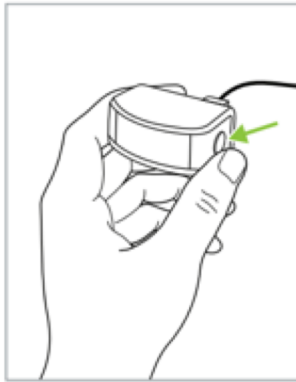

To configure the countdown timer, press and hold the button on the side of the SensorClick motion sensor for 5 seconds until the red LED illuminates. Then press:

- Twice for 10 minutes
- Three times for 30 minutes
- Four times for 60 minutes

After the countdown timer is set, the LED will flash the same number of times the button was pressed to confirm the new timer setting.

Troubleshooting

! There is no power supplied to any of the outlets.

Ensure that the circuit breaker switch on the top of the power strip is not set to off. If so, flip the switch to reset the circuit breaker.

! There is no power supplied to the switched outlets.

The SensorClick motion sensor must be connected to the power strip, and motion must be detected to turn on the switched outlets.

Alternatively, press the button on the motion sensor to manually turn on the switched outlets.

! The SensorClick motion sensor is blinking.

This is a notification that no motion has been detected within the countdown timer period, and that the electronics plugged into the switched outlets will soon shut off.

The LED on the motion sensor will also flash each time motion is detected.

! The electronics plugged into the switched outlets keep switching off.

The power strip shuts off the electronics plugged into the switched outlets after 10/30/60 minutes if no motion is detected by the motion sensor. Ensure that the motion sensor is placed in a proper location and can detect movement. The countdown timer will reset for another 10/30/60 minutes each time motion is detected.