



BERCO
designs

2024 Price List

EFFECTIVE 11/15/23

BERCODESIGNS.COM

GENERAL Terms and Conditions

Terms and Conditions are effective for all shipments beginning January 1, 2015.

Delivered Pricing

Regular ground transportation only dock to dock – via carrier of Berco’s sole discretion. Any additional transportation charges such as, but not limited to, non-standard routing, authorized split shipments, re-consignment, re-delivery, or storage will be the sole responsibility of the customer. Alaska, Hawaii and Puerto Rico prices include shipping to port of embarkation. Additional fees and taxes will be quoted for each specific order.

Small Order Fee

All orders less than \$10,000 list are subject to a \$399 net charge for US destinations.

Crating Fee

Any finished goods requiring crating to protect for damage will incur a \$200 net fee per crate.

Table Installation And Assembly

Table installation and assembly is NOT included in Delivered Pricing. Please arrange for installation and assembly with your Berco Dealer or Representative.

Special Shipping Requests

Any special requests such as “Inside Delivery” will incur additional shipping charges and will be the responsibility of the customer. Please call Customer Service for a quotation. Any special requests made by the customer directly to the carrier will be the sole responsibility of the customer.

Routing

Berco reserves the right to use the carrier of its choice at their sole discretion.

Customer Designated Freight Carriers

For customers designating their own freight carrier, freight charges shall be collect or third party billing. A 5% discount from the net price will apply, with the exception of “Small Orders” as defined in the Small Order Delivery Fee Section. All freight will be subject to the actual freight class. Berco will not be responsible for any billing disputes with shipments FOB Factory. Additionally, any damages or short shipments will be the sole responsibility of the customer with shipments FOB Factory.

INTERNATIONAL SHIPMENTS:

Please contact Customer Service for quotation (888) 772-4788.

GENERAL Terms and Conditions (continued)

Cancellations and Changes:

Cancellations or changes will not be accepted once a purchase order has been acknowledged without express written approval from Berco. Requests for order cancellation or change must be received in writing. If cancellation is approved, a processing fee of 25% of the original purchase amount will be assessed. All non-standard orders for special construction or special finish cannot be cancelled once production has started or materials have been ordered.

Terms of Sale

All prices herein are list prices, freight-prepaid, F.O.B. origin to the 48 contiguous states. Orders to Alaska, Hawaii and Puerto Rico are shipped to port of embarkation.

Illustrations, specifications, and prices are based on the latest information at the time of publication. The right is reserved to make changes at any time without notice regarding pricing, finishes, materials, specifications, and models, and to discontinue models and finishes.

Berco is not responsible for omissions or errors in typography or photography.

All orders are subject to acceptance by Berco. The purchaser is responsible to submit complete orders. Incomplete or incorrect orders will be processed upon reception of the complete information and normal production lead-time will be applied from the date that the complete information is received.

Payment terms: 1% 15 days, Net 30 Days. A 50% deposit prior to order processing must accompany all orders for customers who have not established open account terms with Berco.

Berco does not allow any unearned discounts. All unearned discounts will be charged back to the customer. Interest will be collected at the legal maximum rate on all past due accounts.

Berco does not allow C.O.D. shipments. Credit card payments are subject to 3% processing fee.

Quotes

All Berco price quotations are estimates only. Applicable taxes and other charges may not be included. A quote may be withdrawn at any time. In the event of errors or omissions, the offer will be void and will be corrected upon request. All quotes for custom-manufactured items subject to change pending sign-off on final design drawings. All clerical errors are subject to correction. Customer acceptance of a Berco Quote should be made by issuing a Purchase Order.

GENERAL Terms and Conditions (continued)

New Accounts

Possession of the price list does not constitute an offer to sell. Please contact Berco for your area representative or visit our website, www.BercoDesigns.com.

Order Processing

Purchase Orders must be received in writing. This includes orders sent via U.S. Postal Service, fax and e-mail. All orders received via e-mail must contain either a digital signature or a signed purchase order in PDF format. Duplicate purchase orders not marked "CONFIRMATION" are the sole responsibility of the customer. Purchase Orders must be complete and pricing correct.

Sales Order Acknowledgement

Important: All orders are manufactured and invoiced according to the Sales Order Acknowledgement. Please review your acknowledgement and immediately report any discrepancies to Berco. Modifications to acknowledged orders are not allowed without express written authorization. The details appearing on this acknowledgment will describe the items to be shipped to the purchaser and the ready to ship date (not the actual shipping date). It is the purchaser's responsibility to verify that the acknowledgment information is correct. If not, the purchaser must notify Berco within 48 hours in writing. Failure to provide corrections within 48 hours could be subject to extra charges (see Cancellations and Changes).

Modifications

Modifications to our standard items are available. Call Customer Service for assistance and pricing. Engineering charges will be quoted on the initial purchase, if applicable.

Taxes

Applicable sales and other taxes will be charged separately unless the proper exemption certificate for such taxes is supplied.

Storage Of Goods

If requested, Berco will endeavor to store merchandise for the purchaser. For rates, please contact our Customer Service department.

Repairs

Berco will not allow charges for repairs and deductions for repair costs without prior written authorization. Customer Service will provide the necessary authorization forms and instructions for repairs.

Returns

Returns will not be accepted without prior written authorization by Berco. Berco Customer Service will provide the necessary return authorization forms and Bills of Lading. Returns that are unauthorized and not accompanied by the required documentation and Bills of Lading will be refused. The decision to allow product to be returned is at Berco's sole discretion.

A restocking charge of 25% of the original purchase amount will incur on standard items authorized for return provided all goods are in perfect condition. All freight charges incurred in the return will be the sole responsibility of the customer.

TITLE TRANSFER

Freight Policy

Legal title of the merchandise transfers to the Buyer upon acceptance and pickup by the Freight Carrier from the factory.

OVERVIEW

Berco takes great care to make sure each shipment arrives in perfect condition. On occasion, there is damage that occurs during shipment. If the receiving party follows the procedures outlined below, Berco will assist in filing the freight claim with the Carrier and will do everything possible to eliminate any additional expense incurred by the Buyer. Failure to follow the procedures below can result in the Buyer taking responsibility for the freight claim and any associated costs to replace/repair damaged product.

It is strongly advised that the Buyer open and inspect every item before the Carrier departs. If the Buyer chooses not to inspect every item at the time of delivery, Berco cannot guarantee any claims. In the event the Buyer does not open and inspect items at delivery, the Freight Bill should be signed as follows: No visible damage noted. Any concealed damage to be reported within 5 days. Buyer Signature & Driver Signature

VISIBLE DAMAGE / MISSING ITEMS POLICY & PROCEDURE

It is the Buyer's responsibility to visually inspect all items when they are received – before the Carrier departs. The following process should be followed for any items that appear to have visible damage on the outside of the carton (crushed corner, punctures, scuff marks on packaging, etc.):

1. Open all cartons.
2. Inspect cartons carefully. Confirm receipt of all items against Packing List.
3. Note on the Carrier's Freight Bill the missing items and/or specific damage identified
4. Sign Freight Bill and get driver to sign as well – make a copy for your records
 - a. Freight Bill to be signed as follows: Damage to items XXX (list each item) as shown to driver. Missing items XXX (list each item). Any concealed damage to be reported within 5 days. Buyer Signature & Driver Signature
5. Take digital pictures of the damage (often times the driver will take the necessary pictures) including:
 - a. Damaged carton/packaging (internal and external, if applicable)
 - b. Damaged contents
6. Please hold damaged product and packaging in the event the insurance company needs to review
7. Complete Berco's Damage Report Form and submit to Customer Service

Freight Policy (continued)

CONCEALED DAMAGE POLICY & PROCEDURE

All freight carriers strictly require that concealed damage claims be filed within 5 days of accepted delivery. The carton and damaged unit(s) must be located at the location matching the original delivery address for Carrier inspection. The following procedures must be followed for concealed damage:

1. Once damage is found, stop immediately and take digital pictures:
 - a. Damaged item as it sits in the box
 - b. External and internal carton/packaging
 - c. FAILURE TO TAKE PICTURES AT THIS STAGE WILL RESULT IN A DENIAL OF CONCEALED DAMAGE CLAIM. ONCE ITEM IS INSTALLED, NO CONCEALED DAMAGE CLAIM MAY BE FILED.
2. Complete Berco's Damage Report Form and submit to Customer Service
3. Please hold damaged product and packaging in the event the insurance company needs to review
4. Berco cannot guarantee any Carrier claim settlement on concealed damage. In the event the above is not strictly followed, the Carrier will not even accept the claim for review.

LABOR POLICY

Labor reimbursement for repairs, replacements or storage due to freight damage is not covered by Berco's warranty plan. Invoices for labor charges on damaged or missing items will not be honored unless approved in advance by VP of Sales. If approved, labor is limited to the following maximum amounts: Table: \$15; Top or Base only \$10; no labor for caster or glide replacement. Any approved labor will be issued as a credit on account.

PAYMENT HOLD

Only damaged items that have been properly reported will be authorized for "payment hold" until final resolution. Remittance for balance of non-damaged items must be made within invoice terms to avoid finance charges.

STORAGE POLICY

Berco cannot warranty items in storage under the following circumstances:

1. Storage areas that are not temperature and humidity controlled.
2. Damage claims on items held in storage for more than 15 days from delivery acceptance

FREIGHT PICK UP POLICY

If Buyer selects to pick up freight, they will be responsible for selecting carrier, negotiating rates and terms (including insurance) and remit payment directly to carrier. Buyer agrees to comply with all state and federal laws, rules and regulations regarding shipment of goods from Berco. Customer will be solely responsible for any and all freight claims. Customer assumes all liability associated with shipment. Customer will sign Berco's "Customer Arranged Freight Election & Liability Waiver" form.

HIDDEN DAMAGE REPLACEMENT

In the event that there is hidden damage that is not covered by the Carrier, Berco will replace the item at the following charge: net price PLUS actual shipping cost of replacement LESS 50%. Standard payment terms will apply. Labor will not be paid for hidden damage replacement.

Warranty Policy

CONDITIONAL LIFETIME WARRANTY (subject to exceptions below)

Berco warrants its manufactured products are free of defects in design, material and workmanship for as long as the original purchaser owns them. If written notice of the defect is given to Berco within the applicable warranty period, Berco will repair or replace with comparable product, at Berco's choice, without charge to the original purchaser, which fails under normal use as a result of such defect.

Exceptions

The following are exceptions from the lifetime warranty:

- One Year Warranty: Laminate self-edges, Veneer Tops, Soft Molded Edge Tops, Rainbow Tops, Quarry Resin Tops, Hospitality Chairs & Bases.
- Five Year Warranty: Millwork and other custom fabrication.
- Twelve Year Warranty: Booths
- Items not manufactured by Berco are covered by the Manufacturer Warranty, including: Chairs, Adjustable Height Pedestals, electrification, network accessories, laminate and solid surface material.
- Exclusions From Warranty:
 - Normal wear and tear
 - Customer's own material (COM)
 - Any product that has been abused, altered or subjected to any use other than that which was originally intended
 - Any product cleaned with a solvent-based cleaner
 - Products that were not installed, used, or maintained in accordance with product instructions and warnings
 - Matching of color, grain and texture of wood due to natural variations, which cannot be controlled

At Berco's sole discretion, we will repair or replace any item determined by Berco to be defective as a result of manufacturing defects. In no event shall liability under this warranty exceed the current depreciated price of the defective product.

BERCO'S LIMITED WARRANTY IS PROVIDED IN LIEU OF ALL OTHER WARRANTIES EXPRESS OR IMPLIED, INCLUDING WITHOUT LIMITATION, WARRANTIES OF MERCHANTABILITY AND FITNESS FOR A PARTICULAR PURPOSE, ALL OF WHICH ARE HEREBY SPECIFICALLY DISCLAIMED. BERCO WILL NOT BE RESPONSIBLE FOR CONSEQUENTIAL OR PUNITIVE DAMAGES. BERCO NEITHER ASSUMES NOR AUTHORIZES ANY PERSON TO ASSUME FOR IT ANY OTHER OBLIGATION OR LIABILITY IN CONNECTION WITH THE SALE OF ANY ITEM OR ANY PART THEREOF.

Labor

Labor reimbursement for repairs, replacements or storage due to warranty issues is not covered by Berco's warranty plan. Invoices for labor charges on warranty items will not be honored unless approved in advance by VP of Sales. If approved, labor is limited to the following maximum amounts: Table: \$15; Top or Base only \$10; no labor for caster or glide replacement. Any approved labor will be issued as a credit on account.

Non-Obsolescence Statement

Berco is committed to providing customers with products of comparable aesthetics and function for the life of the warranty period. Despite an effort to maintain full availability of our products, components or materials may become discontinued by our suppliers or by our continuing commitment to produce outstanding quality products. This includes, but is not limited to, finishes, accessories, laminates, and other functional components. Products qualifying for replacement under warranty will be replaced with products of most similar function or aesthetics in the event the identical product is no longer available, at the sole discretion of Berco. In no instance will Berco replace items not qualifying for warranty replacement due to not matching a warranty replacement item.

Legal Disclaimer

This warranty is the Customer's sole remedy for product defect. This warranty does not cover damage by a carrier in transit. Berco makes no warranties, including the implied warranties of merchantability or fitness for a particular purpose, other than the expressed warranties contained herein. There are no other warranties express or implied. Berco shall not be liable for consequential or incidental damages arising from any product defect.

Care and Maintenance

Laminate Surfaces, T-Mold and PVC Edges

Clean with a mild soap solution and rinse with clean water. Wipe the entire surface, moving with the pattern; follow this by wiping with a clean, dry soft cloth.

Wood Edges and Veneer Surfaces

Clean all surfaces frequently with a soft cloth dampened with water. Move the cloth in the direction of the grain. Continue wiping until the wood surface is dry.

Use a soft cloth to immediately remove any liquids that come in contact with wood surfaces. Always blot to absorb spilled liquid, and lift objects to move. To prevent scratching never pull or "scoot" items across the finished surface.

To ensure a lasting finish and protect your furniture from surface damage caused by sharp objects and pens; place a protective pad or glass top on the surface. If using protective glass, place spacer pads under each corner to allow the wood surface to "breathe".

Avoid exposure of furniture to extreme heat or cold, wide humidity variances, and strong sunlight. Do not use or expose furniture to harsh solvents (cleaners with high concentrations of ammonia, etc.). Cleaners of this type will cause the finish to deteriorate.

Powder Coat Surfaces

Clean surface with a mild soap solution. Rinse with a soft cloth dampened with clean water.

Maintenance of Mechanical Parts

For "flip", "folding" and "nesting" tables (the base mechanisms), periodically clean lint and or debris from the moving parts. Do not apply lubricant. Mechanisms have been designed and tested not to require lubricant under normal conditions.

Soft Molded Urethane Edges

Clean edge with self-cleaning wax. For light stains use household cleaner and rinse off with damp cloth. For tough stains apply a damp paste of baking soda. Let stand for a minute and wipe clean. To disinfect, wipe with a diluted bleach solution and rinse off with damp cloth.

Rainbow Resin Edge

Cleaning – dampen a soft cloth with a mild soap and water solution and gently cleanse.

To restore the luster to the edge, a light application of a high-grade furniture wax is recommended.

Precaution. Do not freeze. Do not use abrasive pads; avoid placing hot objects or cigarettes directly on the edge, as damage may occur.

Solid Surface

Solid Surface will maintain its "like new" appearance for years, if the following guidelines are observed:
Heat – Caution – Tabletop may be damaged by placing hot pans from the oven or cook top directly on the table.

Cleaning – Use soap and water; apply with sponge, and towel dry to eliminate water spots.

To Renew Surface – Go over entire surface with a non-abrasive cleaner and a white Scotch-Brite™ pad.

Wash with soap and water, and towel dry, to eliminate water spots.

Cuts and Scratches – To remove cuts and scratches, sand with a block using a 220 or 240 grit sand paper until the cuts are gone.

Chemicals – Solid Surface is very resistant to most household cleaners, but should be protected from industrial cleaners, such as paint removers, paint brush cleaners, metal cleaners, oven cleaners, acetones, nail polish removers, and acid drain cleaners.

Ordering Information

It is easy to place and order for a Berco table. Using Berco Smart-Codes (see "Smart Code" section), you can place an order as follows:

<u>DESCRIPTION</u>	<u>EXAMPLE</u>
1. Select TABLE MODEL number	VS1
2. Select TABLE TOP SHAPE	REC
3. Select TABLE SIZE	3060
4. Select Top SURFACE	
4.a. Manufacturer	Wilsonart
4.b. Number and Finish	4622-60
4.c. Color Description	Grey Nebula
5. Select Top EDGE PROFILE	L-21
6. Select Top EDGE COLOR	E07
9. Select Any Applicable OPTIONS	Refer To Price List For Available Options
7. Select BASE STYLE	NST (nesting)
8. Select BASE FINISH	S15

GSA Contract Specifications

GSA Contract Information

Schedule 71 Furniture

Contract Number: GS-27F-0008CA

Contract Period: February 3, 2015 – February 2, 2020

Contract Number: GS-27F-0009CA

Contract Period: February 5, 2015 – February 5, 2020

General Information:

Business Size Small (Corporation)

DUNS No. 195888420

Cage Code 52C59

Contract Terms and Conditions

- 1.a Special Item Numbers (SIN)
 - SIN 71-11 Tables and Accessories
 - SIN 71-12 System Type Tables (Small Business Set Aside)

2. Maximum Order
 - Contract GS-27F-0008CA \$300,000-All orders shall be for one location
 - Contract GS-27F-0009CA \$500,000-All orders shall be for one location

3. Minimum Order
 - \$100.00 Net Purchase Price – all orders shall be for one location

4. Geographic Coverage
 - The 48 Contiguous States and Washington, DC (CONUS). Shipments for AK, HA, GU, PR etc. are FOB point of embarkation within the continental United States (CONUS). For "International" Use of Domestic Schedules: Activities shall provide forwarding instructions and/or TCN documentation and/or instructions.

5. Points of Production
 - Saint Louis, Missouri

6. Discount Statement
 - Discount applied to list prices are: 57.7%
 - Federal orders combined for discount shall be to the same destination and time of shipment, and shall be cross referenced to one another (unless otherwise detailed by Blanket Purchase Agreement).

GSA Contract Specifications

7. Quantity Discounts

Net Sales \$ Amount

\$100 - 15,000	0%
\$15,001 - 50,000	1%
\$50,001 - 100,000	2%
\$100,001 - 150,000	3%
\$150,001 - 250,000	4%
\$250,001 - 350,000	5%
\$350,000 - 500,000	6%

8. Payment Terms: 1% - 15%, Net 30 Days

9. Government Credit Cards

Government credit cards are accepted above or below micropurchase levels.

Use of credit cards shall be at time of order placement with cards charged at time of shipment or performance.

10. Foreign Items

None.

11.a Time Of Delivery

45 – 90 Days (ARO)

11.b.c.d Not Available

12. F.O.B

(Standard Dock Delivery)

13. Ordering Address

Agencies send completed purchase orders or credit card orders to:

Fairway Holdings
C/O Dealer of Record
111 Winnebago St.
Saint Louis, MO 63118
Phone: 888-772-4788
Fax: 888-772-4789

14. Payment Address

Fairway Holdings
111 Winnebago St
Saint Louis, MO 63118
Phone: 888-772-4788
Fax: 888-772-4789

15. Warranty: Standard Commercial Warranty

GSA Contract Specifications

16. Export Packaging Charges
Price Quoted Upon Request
17. N/A
18. N/A
19. Installation
N/A
20. N/A
21. N/A
22. Participating Dealers
Any Authorized Berco Dealer
23. N/A
24. Year 2000 Compliant - yes
25. Data Universal Numbering System (DUNS)
DUNS No. 19-588-8420
26. System for Award Management (SAM) database
Active and current in SAM, Cage Code 52c59
27. Restocking Charges
Restocking charges of 25% applicable for items cancelled after production begins. All returns must be pre-approved in writing prior to return.
28. Cancellation
Cancellation at no charge prior to production

TABLES



Table Top Specifications

When it comes to tops, the options are limitless. Berco offers every imaginable surface option, and if you don't see what you are looking for in our standard collection, chances are our Customer Service team can find a solution to meet your specific needs.

Standard Core: Standard core is 1-1/8" thick 45# industrial grade particleboard.

Laminate Tops: Tops are laminated under continuous pressure using cold PVA glue with HPL laminate and balanced with backing sheet. Berco offers dozens of standard laminate selections from the Wilsonart collection (see "Standard Laminate Table Top Finish Option" section). Please consult Customer Service for pricing and availability for Formica, Nevamar, Pionite, and other brands of laminates.

Veneer Tops: Veneer is 0.020" thick, select quality, rotary cut or plain sliced. All faces are book matched and balanced. Panels are backed with a commercial balanced backer. Veneer tops are finished with a multicoated system of catalyzed, semi-gloss varnish. Standard veneer finishes include maple, oak, cherry and mahogany (see "Standard Wood Finish Options" section) and we will be happy to work with you to find a more exotic wood finish or custom color – please consult Customer Service for pricing and availability.

Solid Surface Tops: Solid surface is the most durable table top material. Ideal for high-traffic spaces, solid surface is a non-porous product that is heat and stain resistant. Solid surface provides a high-end look with long-term durability. Berco works closely with most major solid surface providers including, Corian, LG Surfaces, Wilsonart, Avonite and Hanex. Please consult Customer Service for pricing and availability.

Resin Table Tops: Resin is a heavy-duty material designed to withstand wear and tear. It has a contemporary styling that is easy to customize with a school or company logo. Resin tops are also chemical resistant and easy to clean. Berco offers unlimited color options to meet your specific needs. Our standard resin colors are found in the "Standard Resin Finish Option" section. Please consult Customer Service for pricing and availability.

Lightweight Tops: Our lightweight solid core material is 1" thick, and available on select stationary and folding tables at an additional charge. These tops are approximately 30% lighter than our standard tops. Lightweight tops are limited to P-12 PVC edges.

Edging: Offered in a variety of edge styles including vinyl, PVC, wood and resin. See "Edge Style" and "Edge Finish Colors" sections for more information on standard offerings. Custom options also available – consult Customer Service.

TABLE HEIGHT

All tables are 29" overall height within industry tolerances, including top and pedestal. Special heights are available.

TABLE ASSEMBLY

Stationary and flip top tables (non-solid surface or metal inserts) come equipped with Phillips wood screws for attaching pedestal to table top. See specific "Table Assembly" section for more detailed assembly instructions. General table assembly information is as follows:

Stationary tables: Pedestal and top shipped separately.

Folding tables: Legs factory installed at no additional charge.

Flip-Top tables: Pedestal and top shipped separately.

Nesting tables: Pedestal and top shipped separately. Top includes Nesting structure already attached to it.

ANYWAY



ANYWAY

AnyWay Tables were designed to have a low profile foot that creates the ideal comfortable resting place for your feet, in addition, the aesthetic of this base allows its design to work in any architectural environment.

Table Pedestal Specifications Finishes: Available in 40+ standard powder coat finishes. Our unique mechanical construction enables a flawless seam when mixing column finishes with any base finish. Custom finishes available. Please contact Customer Service for quotation.

Glides and Casters: All tables are equipped with 2" diameter glide with brushed stainless steel cover over black ABS foot. The stem is M10 and 15mm long. The glide is suitable for carpet, as well as hard floors. High quality twin wheel locking casters are offered as an option.

Stationary Table Pedestals: Constructed of cold finished flat steel 1/4" x 2" foot, attached to a 2" 14 gauge steel or 3" 16 gauge columns with powder coated 10" locking cast spider; larger pedestals equipped with 15" cast spider, machined for column recess to insure levelness.

AnyWay Folding Table Leg Specifications

Our patented spring loaded folding mechanism is fully riveted to a steel mounting plate. Vinyl bumpers are integrated into the mechanism allowing for a non-marring, 3-1/2" stacking height. Equipped with molded release handle and integral catch holds leg in folded position.

AnyWay Table Options

There are several options available on AnyWay including:

- Nesting
- Folding
- Flip Top
- Special Height
- Adjustable Height
- Center Mount Electrical Column

ANYWAY

ANYWAY BASE SPECIFICATIONS

Single Column End Smart Code Base Size Column Diameter Top Capacity
Base



AN1-16EB	16"	2"	18"x96"
AN1-23EB	23"	2"	24"x96"
AN1-26EB	26"	2"	36"x96"

Double Column End Smart Code Base Size Column Diameter Top Capacity
Base

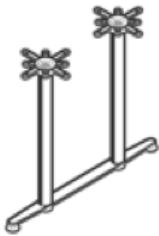

AN2-32EB	32"	2"	42"x96"
AN2-39EB	39"	2"	48"x96"

Cross Base Smart Code Base Size Column Diameter Top Capacity

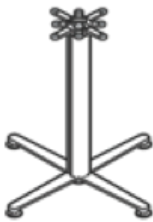

ANX-23	23"	3"	24" SQ & RND
ANX-26	26"	3"	30" SQ & RND
ANX-36-3	36" – 3"	3"	36" SQ & 42" RND
ANX-36-4	36" – 4"	4"	42" SQ & 54" RND

ANYWAY TABLES - (LAMINATE - PVC EDGE)



		Edge Choices: PVC & T-Mold				Laminate Upgrades		Light Weight	OPTIONS							
		T-15	L-21	P-14	PK-2	Laminate Upgrade I	Laminate Upgrade II	Light Weight (PVC only - 1" top)	NESTING	FOLDING	FLIP-TOP	POWDERCOAT UPGRADE	DELUXE CASTERS (BLK)	CENTER MOUNT ELEC. COLUMN	ADJ. HEIGHT PIN	SPECIAL HEIGHT
		P-10 (self)	P-12		PK-4	ADD	ADD	ADD	ADD	ADD	ADD	ADD	ADD	ADD	ADD	ADD
		L-15			L-23											
SQUARE (SQR)																
ANX	24x24	\$663	\$696	\$729	\$50	\$133	\$116	N/A	N/A	\$112	\$134	\$163	\$338	N/A	\$80	
ANX	30x30	\$759	\$797	\$835	\$57	\$152	\$133	N/A	N/A	\$112	\$134	\$163	\$338	N/A	\$80	
ANX	36x36	\$847	\$890	\$932	\$64	\$169	\$148	N/A	N/A	\$112	\$134	\$163	\$338	N/A	\$80	
ANX	42x42	\$949	\$996	\$1,044	\$71	\$190	\$166	N/A	N/A	\$112	\$134	\$163	N/A	N/A	\$80	
ROUND (RND)																
ANX	30	\$785	\$824	\$864	\$59	\$157	\$137	N/A	N/A	\$112	\$134	\$163	\$338	N/A	\$80	
ANX	36	\$870	\$914	\$957	\$65	\$174	\$152	N/A	N/A	\$112	\$134	\$163	\$338	N/A	\$80	
ANX	42	\$1,106	\$1,162	\$1,217	\$83	\$221	\$194	N/A	N/A	\$112	\$134	\$163	\$338	N/A	\$80	
ANX	48	\$1,218	\$1,278	\$1,339	\$91	\$244	\$213	N/A	N/A	\$112	\$134	\$163	N/A	N/A	\$80	
ANX	54	\$1,362	\$1,431	\$1,499	\$102	\$272	\$238	N/A	N/A	N/A	\$134	\$163	N/A	N/A	\$80	
RECTANGLE (REC)																
AN1	18x48	\$823	\$864	\$905	\$62	\$165	\$144	\$389	N/A	N/A	\$134	\$163	N/A	N/A	\$133	
AN1	18x60	\$878	\$922	\$966	\$66	\$176	\$154	\$389	\$424	N/A	\$134	\$163	N/A	N/A	\$133	
AN1	18x72	\$933	\$979	\$1,026	\$70	\$187	\$163	\$389	\$424	N/A	\$134	\$163	N/A	N/A	\$133	
AN1	18x84	\$988	\$1,037	\$1,087	\$74	\$198	\$173	\$389	\$424	N/A	\$134	\$163	N/A	N/A	\$133	
AN1	18x96	\$1,043	\$1,095	\$1,147	\$78	\$209	\$183	\$389	\$424	N/A	\$134	\$163	N/A	N/A	\$133	
AN1	24x48	\$890	\$934	\$979	\$67	\$178	\$156	\$389	N/A	N/A	\$134	\$163	N/A	\$711	\$133	
ANX	24x48 (ANX2339-2)	\$1,049	\$1,101	\$1,154	\$79	\$210	\$184	N/A	N/A	N/A	\$268	N/A	N/A	N/A	\$265	
AN1	24x60	\$958	\$1,006	\$1,054	\$72	\$192	\$168	\$389	\$424	N/A	\$134	\$163	N/A	\$711	\$133	
AN1	24x72	\$1,026	\$1,077	\$1,129	\$77	\$205	\$180	\$389	\$424	N/A	\$134	\$163	N/A	\$711	\$133	
AN1	24x84	\$1,094	\$1,149	\$1,204	\$82	\$219	\$192	\$389	\$424	N/A	\$134	\$163	N/A	N/A	\$133	
AN1	24x96	\$1,163	\$1,221	\$1,279	\$87	\$233	\$203	\$389	\$424	N/A	\$134	\$163	N/A	N/A	\$133	
AN1	30x36	\$890	\$935	\$979	\$67	\$178	\$156	\$389	N/A	N/A	\$134	\$163	N/A	\$711	\$133	
AN1	30x42	\$931	\$978	\$1,024	\$70	\$186	\$163	\$389	N/A	N/A	\$134	\$163	N/A	\$711	\$133	
AN1	30x48	\$972	\$1,020	\$1,069	\$73	\$194	\$170	\$389	N/A	N/A	\$134	\$163	N/A	\$711	\$133	
ANX	30x48 (ANX2639-2)	\$1,098	\$1,153	\$1,208	\$82	\$220	\$192	N/A	N/A	N/A	\$268	N/A	N/A	N/A	\$265	
AN1	30x60	\$1,053	\$1,106	\$1,159	\$79	\$211	\$184	\$389	\$424	N/A	\$134	\$163	N/A	\$711	\$133	
AN1	30x72	\$1,062	\$1,115	\$1,168	\$80	\$212	\$186	\$389	\$424	N/A	\$134	\$163	N/A	\$711	\$133	
AN1	30x84	\$1,216	\$1,277	\$1,338	\$91	\$243	\$213	\$389	\$424	N/A	\$134	\$163	N/A	N/A	\$133	
AN1	30x96	\$1,298	\$1,363	\$1,428	\$97	\$260	\$227	\$389	\$424	N/A	\$134	\$163	N/A	N/A	\$133	
AN1	36x48	\$1,032	\$1,084	\$1,136	\$77	\$206	\$181	\$389	N/A	N/A	\$134	\$163	N/A	N/A	\$133	
AN1	36x60	\$1,127	\$1,184	\$1,240	\$85	\$225	\$197	\$389	\$424	N/A	\$134	\$163	N/A	N/A	\$133	
AN1	36x72	\$1,222	\$1,283	\$1,344	\$92	\$244	\$214	\$389	\$424	N/A	\$134	\$163	N/A	N/A	\$133	
AN1	36x84	\$1,317	\$1,383	\$1,448	\$99	\$263	\$230	\$389	\$424	N/A	\$134	\$163	N/A	N/A	\$133	
AN1	36x96	\$1,412	\$1,482	\$1,553	\$106	\$282	\$247	\$389	\$424	N/A	\$134	\$163	N/A	N/A	\$133	
AN2	42x48	\$1,576	\$1,655	\$1,734	\$118	\$315	\$276	N/A	N/A	N/A	\$134	\$163	N/A	N/A	\$228	
AN2	42x60	\$1,684	\$1,768	\$1,852	\$126	\$337	\$295	N/A	N/A	N/A	\$134	\$163	N/A	N/A	\$228	
AN2	42x72	\$1,792	\$1,882	\$1,971	\$134	\$358	\$314	N/A	N/A	N/A	\$134	\$163	N/A	N/A	\$228	
AN2	42x84	\$1,900	\$1,995	\$2,090	\$143	\$380	\$333	N/A	N/A	N/A	\$134	\$163	N/A	N/A	\$228	
AN2	42x96	\$2,008	\$2,109	\$2,209	\$151	\$402	\$351	N/A	N/A	N/A	\$134	\$163	N/A	N/A	\$228	
AN2	48x60	\$1,829	\$1,921	\$2,012	\$137	\$366	\$320	N/A	N/A	N/A	\$134	\$163	N/A	N/A	\$228	
AN2	48x72	\$1,950	\$2,048	\$2,146	\$146	\$390	\$341	N/A	N/A	N/A	\$134	\$163	N/A	N/A	\$228	
AN2	48x84	\$2,072	\$2,175	\$2,279	\$155	\$414	\$363	N/A	N/A	N/A	\$134	\$163	N/A	N/A	\$228	
AN2	48x96	\$2,193	\$2,303	\$2,412	\$164	\$439	\$384	N/A	N/A	N/A	\$134	\$163	N/A	N/A	\$228	

ANYWAY TABLES - (LAMINATE - PVC EDGE)



		Edge Choices: PVC & T-Mold				Laminate Upgrades		Light Weight	OPTIONS								
		T-15	L-21	P-14	PK-2	Laminate Upgrade I	Laminate Upgrade II	Light Weight (PVC only - 1" top)	NESTING	FOLDING	FLIP-TOP	POWDERCOAT UPGRADE	DELUXE CASTERS (BLK)	CENTER MOUNT ELEC. COLUMN	ADJ. HEIGHT PIN	SPECIAL HEIGHT	
		P-10 (self)	P-12		PK-4	L-15	L-23	ADD	ADD	ADD	ADD	ADD	ADD	ADD	ADD	ADD	ADD
RACETRACK (RAC)																	
AN1	36x72		\$1,307	\$1,372	\$1,438	\$98	\$261	\$229	\$389	\$424	N/A	\$134	\$163	N/A	N/A	N/A	\$133
AN1	36x84		\$1,402	\$1,472	\$1,542	\$105	\$280	\$245	\$389	\$424	N/A	\$134	\$163	N/A	N/A	N/A	\$133
AN1	36x96		\$1,496	\$1,571	\$1,646	\$112	\$299	\$262	\$389	\$424	N/A	\$134	\$163	N/A	N/A	N/A	\$133
AN2	42x96		\$2,093	\$2,198	\$2,302	\$157	\$419	\$366	N/A	N/A	N/A	\$134	\$163	N/A	N/A	N/A	\$228
AN2	42x120 (1 piece)		\$2,791	\$2,930	\$3,070	\$209	\$558	N/A	N/A	N/A	N/A	\$134	\$244	N/A	N/A	N/A	\$228
AN2	42x144 (1 piece)		\$3,007	\$3,157	\$3,307	\$226	\$601	N/A	N/A	N/A	N/A	\$134	\$244	N/A	N/A	N/A	\$228
AN2	48x96		\$2,278	\$2,392	\$2,506	\$171	\$456	\$399	N/A	N/A	N/A	\$134	\$163	N/A	N/A	N/A	\$228
AN2	48x120 (1 piece)		\$3,038	\$3,190	\$3,341	\$228	\$608	N/A	N/A	N/A	N/A	\$134	\$244	N/A	N/A	N/A	\$228
AN2	48x144 (1 piece)		\$3,280	\$3,444	\$3,608	\$246	\$656	N/A	N/A	N/A	N/A	\$134	\$244	N/A	N/A	N/A	\$228
BOAT (BOT)																	
AN2	36x48x120 (1 piece)		\$3,038	\$3,190	\$3,341	\$228	\$608	N/A	N/A	N/A	N/A	\$134	\$244	N/A	N/A	N/A	\$228
AN2	36x48x144 (1 piece)		\$3,280	\$3,444	\$3,608	\$246	\$656	N/A	N/A	N/A	N/A	\$134	\$244	N/A	N/A	N/A	\$228
AN2	42x54x120 (1 piece)		\$3,178	\$3,337	\$3,496	\$238	\$636	N/A	N/A	N/A	N/A	\$134	\$244	N/A	N/A	N/A	\$228
AN2	42x54x144 (1 piece)		\$3,447	\$3,619	\$3,792	\$259	\$689	N/A	N/A	N/A	N/A	\$134	\$244	N/A	N/A	N/A	\$228
OVAL (OVL)																	
AN1	36x60		\$1,212	\$1,273	\$1,333	\$91	\$242	\$212	\$389	N/A	N/A	\$134	\$163	N/A	N/A	N/A	\$133
AN1	36x72		\$1,307	\$1,372	\$1,438	\$98	\$261	\$229	\$389	\$424	N/A	\$134	\$163	N/A	N/A	N/A	\$133
AN1	36x84		\$1,402	\$1,472	\$1,542	\$105	\$280	\$245	\$389	\$424	N/A	\$134	\$163	N/A	N/A	N/A	\$133
AN1	36x96		\$1,496	\$1,571	\$1,646	\$112	\$299	\$262	\$389	\$424	N/A	\$134	\$163	N/A	N/A	N/A	\$133
AN2	42x72		\$1,877	\$1,971	\$2,065	\$141	\$375	\$328	N/A	N/A	N/A	\$134	\$163	N/A	N/A	N/A	\$228
AN2	42x84		\$1,985	\$2,084	\$2,183	\$149	\$397	\$347	N/A	N/A	N/A	\$134	\$163	N/A	N/A	N/A	\$228
AN2	42x96		\$2,093	\$2,198	\$2,302	\$157	\$419	\$366	N/A	N/A	N/A	\$134	\$163	N/A	N/A	N/A	\$228
AN2	48x84		\$2,157	\$2,264	\$2,372	\$162	\$431	\$377	N/A	N/A	N/A	\$134	\$163	N/A	N/A	N/A	\$228
AN2	48x96		\$2,278	\$2,392	\$2,506	\$171	\$456	\$399	N/A	N/A	N/A	\$134	\$163	N/A	N/A	N/A	\$228
AN2	48x120 (1 piece)		\$3,038	\$3,190	\$3,341	\$228	\$608	N/A	N/A	N/A	N/A	\$134	\$163	N/A	N/A	N/A	\$228
TRAPEZOID (TRP)																	
AN1	24x24x48		\$974	\$1,023	\$1,072	\$73	\$195	\$171	\$389	N/A	N/A	\$134	\$163	N/A	N/A	N/A	\$133
AN1	24x36x60		\$1,191	\$1,250	\$1,310	\$89	\$238	\$208	\$389	N/A	N/A	\$134	\$163	N/A	N/A	N/A	\$133
AN1	30x30x60		\$1,138	\$1,195	\$1,252	\$85	\$228	\$199	\$389	N/A	N/A	\$134	\$163	N/A	N/A	N/A	\$133
AN1	30x42x72		\$1,394	\$1,464	\$1,533	\$105	\$279	\$244	\$389	N/A	N/A	\$134	\$163	N/A	N/A	N/A	\$133
HALF ROUND (HRD)																	
AN1	24x48		\$919	\$965	\$1,011	\$69	\$184	\$161	\$389	N/A	N/A	\$134	\$163	N/A	N/A	N/A	\$133
AN1	30x60		\$1,079	\$1,133	\$1,187	\$81	\$216	\$189	\$389	N/A	N/A	\$134	\$163	N/A	N/A	N/A	\$133
AN1	36x72		\$1,245	\$1,307	\$1,369	\$93	\$249	\$218	\$389	N/A	N/A	\$134	\$163	N/A	N/A	N/A	\$133
CRESCENT (CRT)																	
AN1	24x24x48		\$974	\$1,023	\$1,072	\$73	\$195	\$171	\$389	N/A	N/A	\$134	\$163	N/A	N/A	N/A	\$133
AN1	30x30x60		\$1,138	\$1,195	\$1,252	\$85	\$228	\$199	\$389	N/A	N/A	\$134	\$163	N/A	N/A	N/A	\$133







ANYWAY TABLES - (LAMINATE - WOOD EDGE)



Edge Choice: Wood (Red Oak & Maple)				Wood Upgrade	OPTIONS								
W-12	W-23	W-19		Upgrade: Walnut / Mahogany / Cherry	NESTING	FOLDING	FLIP-TOP	POWDERCOAT UPGRADE	DELUXE CASTERS (BLK)	CENTER MOUNT ELEC. COLUMN	ADJ. HEIGHT PIN	SPECIAL HEIGHT	
	W-18	W-17		ADD	ADD	ADD	ADD	ADD	ADD	ADD	ADD	ADD	
	W-16	W-32											
SQUARE (SQR)													
ANX 24x24	\$994	\$1,160	\$1,325	15%	N/A	N/A	\$112	\$134	\$163	\$338	N/A	\$80	
ANX 30x30	\$1,139	\$1,329	\$1,518	15%	N/A	N/A	\$112	\$134	\$163	\$338	N/A	\$80	
ANX 36x36	\$1,271	\$1,483	\$1,695	15%	N/A	N/A	\$112	\$134	\$163	\$338	N/A	\$80	
ANX 42x42	\$1,779	\$2,135	\$2,372	15%	N/A	N/A	\$112	\$134	\$163	N/A	N/A	\$80	
ROUND (RND)													
ANX 30	\$1,178	\$1,374	\$1,570	15%	N/A	N/A	\$112	\$134	\$163	\$338	N/A	\$80	
ANX 36	\$1,305	\$1,523	\$1,740	15%	N/A	N/A	\$112	\$134	\$163	\$338	N/A	\$80	
ANX 42	\$2,074	\$2,489	\$2,766	15%	N/A	N/A	\$112	\$134	\$163	\$338	N/A	\$80	
ANX 48	\$2,283	\$2,740	\$3,044	15%	N/A	N/A	\$112	\$134	\$163	N/A	N/A	\$80	
ANX 54	\$2,555	\$3,066	\$3,406	15%	N/A	N/A	N/A	\$134	\$163	N/A	N/A	\$80	
RECTANGLE (REC)													
AN1 18x48	\$1,234	\$1,440	\$1,645	15%	\$389	N/A	N/A	\$134	\$163	N/A	N/A	\$133	
AN1 18x60	\$1,317	\$1,536	\$1,756	15%	\$389	\$424	N/A	\$134	\$163	N/A	N/A	\$133	
AN1 18x72	\$1,399	\$1,632	\$1,866	15%	\$389	\$424	N/A	\$134	\$163	N/A	N/A	\$133	
AN1 18x84	\$1,564	\$1,825	\$2,086	15%	\$389	\$424	N/A	\$134	\$163	N/A	N/A	\$133	
AN1 18x96	\$1,564	\$1,825	\$2,086	15%	\$389	\$424	N/A	\$134	\$163	N/A	N/A	\$133	
AN1 24x48	\$1,334	\$1,557	\$1,779	15%	\$389	N/A	N/A	\$134	\$163	N/A	\$711	\$133	
ANX 24x48 (ANX2339-2)	\$1,397	\$1,634	\$1,858	15%	N/A	N/A	N/A	\$268	N/A	N/A	N/A	\$265	
AN1 24x60	\$1,437	\$1,676	\$1,916	15%	\$389	\$424	N/A	\$134	\$163	N/A	\$711	\$133	
AN1 24x72	\$1,539	\$1,796	\$2,052	15%	\$389	\$424	N/A	\$134	\$163	N/A	\$711	\$133	
AN1 24x84	\$1,744	\$2,035	\$2,325	15%	\$389	\$424	N/A	\$134	\$163	N/A	N/A	\$133	
AN1 24x96	\$1,744	\$2,035	\$2,325	15%	\$389	\$424	N/A	\$134	\$163	N/A	N/A	\$133	
AN1 30x36	\$1,335	\$1,558	\$1,781	15%	\$389	N/A	N/A	\$134	\$163	N/A	\$711	\$133	
AN1 30x42	\$1,397	\$1,629	\$1,862	15%	\$389	N/A	N/A	\$134	\$163	N/A	\$711	\$133	
AN1 30x48	\$1,458	\$1,701	\$1,944	15%	\$389	N/A	N/A	\$134	\$163	N/A	\$711	\$133	
ANX 30x48 (ANX2639-2)	\$1,495	\$1,749	\$1,988	15%	N/A	N/A	N/A	\$268	N/A	N/A	N/A	\$265	
AN1 30x60	\$1,580	\$1,843	\$2,107	15%	\$389	\$424	N/A	\$134	\$163	N/A	\$711	\$133	
AN1 30x72	\$1,593	\$1,859	\$2,124	15%	\$389	\$424	N/A	\$134	\$163	N/A	\$711	\$133	
AN1 30x84	\$1,947	\$2,271	\$2,596	15%	\$389	\$424	N/A	\$134	\$163	N/A	N/A	\$133	
AN1 30x96	\$1,947	\$2,271	\$2,596	15%	\$389	\$424	N/A	\$134	\$163	N/A	N/A	\$133	
AN1 36x48	\$1,549	\$1,807	\$2,065	15%	\$389	N/A	N/A	\$134	\$163	N/A	N/A	\$133	
AN1 36x60	\$1,691	\$1,973	\$2,254	15%	\$389	\$424	N/A	\$134	\$163	N/A	N/A	\$133	
AN1 36x72	\$1,833	\$2,139	\$2,444	15%	\$389	\$424	N/A	\$134	\$163	N/A	N/A	\$133	
AN1 36x84	\$2,117	\$2,470	\$2,823	15%	\$389	\$424	N/A	\$134	\$163	N/A	N/A	\$133	
AN1 36x96	\$2,117	\$2,470	\$2,823	15%	\$389	\$424	N/A	\$134	\$163	N/A	N/A	\$133	
AN2 42x48	\$2,955	\$3,546	\$3,940	15%	N/A	N/A	N/A	\$134	\$163	N/A	N/A	\$228	
AN2 42x60	\$3,158	\$3,789	\$4,210	15%	N/A	N/A	N/A	\$134	\$163	N/A	N/A	\$228	
AN2 42x72	\$3,379	\$4,054	\$4,505	15%	N/A	N/A	N/A	\$134	\$163	N/A	N/A	\$228	
AN2 42x84	\$3,789	\$4,547	\$5,052	15%	N/A	N/A	N/A	\$134	\$163	N/A	N/A	\$228	
AN2 42x96	\$3,789	\$4,547	\$5,052	15%	N/A	N/A	N/A	\$134	\$163	N/A	N/A	\$228	
AN2 48x60	\$3,430	\$4,116	\$4,573	15%	N/A	N/A	N/A	\$134	\$163	N/A	N/A	\$228	
AN2 48x72	\$3,657	\$4,389	\$4,876	15%	N/A	N/A	N/A	\$134	\$163	N/A	N/A	\$228	
AN2 48x84	\$4,112	\$4,934	\$5,483	15%	N/A	N/A	N/A	\$134	\$163	N/A	N/A	\$228	
AN2 48x96	\$4,112	\$4,934	\$5,483	15%	N/A	N/A	N/A	\$134	\$163	N/A	N/A	\$228	

ANYWAY TABLES - (LAMINATE - WOOD EDGE)



		Edge Choice: Wood (Red Oak & Maple)			Wood Upgrade	OPTIONS							
					Upgrade: Walnut / Mahogany / Cherry	NESTING	FOLDING	FLIP-TOP	POWDERCOAT UPGRADE	DELUXE CASTERS (BLK)	CENTER MOUNT ELEC. COLUMN	ADJ. HEIGHT PIN	SPECIAL HEIGHT
													
RACETRACK (RAC)													
AN1	36x72	\$1,960	\$2,287	\$2,614	15%	\$389	\$424	N/A	\$134	\$163	N/A	N/A	\$133
AN1	36x84	\$2,245	\$2,619	\$2,993	15%	\$389	\$424	N/A	\$134	\$163	N/A	N/A	\$133
AN1	36x96	\$2,245	\$2,619	\$2,993	15%	\$389	\$424	N/A	\$134	\$163	N/A	N/A	\$133
AN2	42x96	\$4,271	\$5,125	\$5,695	15%	N/A	N/A	N/A	\$134	\$163	N/A	N/A	\$228
AN2	42x120 (1 piece)	\$5,696	\$6,835	\$7,594	15%	N/A	N/A	N/A	\$134	\$244	N/A	N/A	\$228
AN2	42x144 (1 piece)	\$6,151	\$7,381	\$8,201	15%	N/A	N/A	N/A	\$134	\$244	N/A	N/A	\$228
AN2	48x96	\$4,271	\$5,125	\$5,695	15%	N/A	N/A	N/A	\$134	\$163	N/A	N/A	\$228
AN2	48x120 (1 piece)	\$5,696	\$6,835	\$7,594	15%	N/A	N/A	N/A	\$134	\$244	N/A	N/A	\$228
AN2	48x144 (1 piece)	\$6,151	\$7,381	\$8,201	15%	N/A	N/A	N/A	\$134	\$244	N/A	N/A	\$228
BOAT (BOT)													
AN2	36x48x120 (1 piece)	\$4,557	\$5,316	\$6,075	15%	N/A	N/A	N/A	\$134	\$244	N/A	N/A	\$228
AN2	36x48x144 (1 piece)	\$4,921	\$5,741	\$6,561	15%	N/A	N/A	N/A	\$134	\$244	N/A	N/A	\$228
AN2	42x54x120 (1 piece)	\$4,784	\$5,582	\$6,379	15%	N/A	N/A	N/A	\$134	\$244	N/A	N/A	\$228
AN2	42x54x144 (1 piece)	\$5,149	\$6,007	\$6,865	15%	N/A	N/A	N/A	\$134	\$244	N/A	N/A	\$228
OVAL (OVL)													
AN1	36x60	\$1,960	\$2,287	\$2,614	15%	\$389	N/A	N/A	\$134	\$163	N/A	N/A	\$133
AN1	36x72	\$1,960	\$2,287	\$2,614	15%	\$389	\$424	N/A	\$134	\$163	N/A	N/A	\$133
AN1	36x84	\$2,245	\$2,619	\$2,993	15%	\$389	\$424	N/A	\$134	\$163	N/A	N/A	\$133
AN1	36x96	\$2,245	\$2,619	\$2,993	15%	\$389	\$424	N/A	\$134	\$163	N/A	N/A	\$133
AN2	42x72	\$2,823	\$3,293	\$3,764	15%	N/A	N/A	N/A	\$134	\$163	N/A	N/A	\$228
AN2	42x84	\$3,232	\$3,771	\$4,310	15%	N/A	N/A	N/A	\$134	\$163	N/A	N/A	\$228
AN2	42x96	\$3,232	\$3,771	\$4,310	15%	N/A	N/A	N/A	\$134	\$163	N/A	N/A	\$228
AN2	48x84	\$3,523	\$4,110	\$4,698	15%	N/A	N/A	N/A	\$134	\$163	N/A	N/A	\$228
AN2	48x96	\$4,271	\$5,125	\$5,695	15%	N/A	N/A	N/A	\$134	\$163	N/A	N/A	\$228
AN2	48x120 (1 piece)	\$5,696	\$6,835	\$7,594	15%	N/A	N/A	N/A	\$134	\$163	N/A	N/A	\$228
TRAPEZOID (TRP)													
AN1	24x24x48	\$1,657	\$1,939	\$2,204	15%	\$389	N/A	N/A	\$134	\$163	N/A	N/A	\$133
AN1	24x36x60	\$1,929	\$2,256	\$2,565	15%	\$389	N/A	N/A	\$134	\$163	N/A	N/A	\$133
AN1	30x30x60	\$1,844	\$2,157	\$2,452	15%	\$389	N/A	N/A	\$134	\$163	N/A	N/A	\$133
AN1	30x42x72	\$2,258	\$2,642	\$3,004	15%	\$389	N/A	N/A	\$134	\$163	N/A	N/A	\$133
HALF ROUND (HRD)													
AN1	24x48	\$1,563	\$1,829	\$2,079	15%	\$389	N/A	N/A	\$134	\$163	N/A	N/A	\$133
AN1	30x60	\$1,836	\$2,148	\$2,442	15%	\$389	N/A	N/A	\$134	\$163	N/A	N/A	\$133
AN1	36x72	\$2,117	\$2,477	\$2,816	15%	\$389	N/A	N/A	\$134	\$163	N/A	N/A	\$133
CRESCENT (CRT)													
AN1	24x24x48	\$1,657	\$1,939	\$2,204	15%	\$389	N/A	N/A	\$134	\$163	N/A	N/A	\$133
AN1	30x30x60	\$1,936	\$2,265	\$2,575	15%	\$389	N/A	N/A	\$134	\$163	N/A	N/A	\$133

ANYWAY TABLES - (VENEER)



Edge Choice: Wood (Red Oak & Maple)				Wood Upgrade	OPTIONS							
V-12	V-23	V-19		Upgrade: Walnut / Mahogany / Cherry	NESTING	FLIP-TOP	POWDERCOAT UPGRADE	DELUXE CASTERS (BLK)	CENTER MOUNT ELEC. COLUMN	ADJ. HEIGHT PIN	SPECIAL HEIGHT	
	V-18	V-17										ADD
	V-16	V-32										
SQUARE (SQR)												
ANX 24x24	\$1,149	\$1,264	\$1,322	15%	N/A	\$112	\$134	\$163	\$338	N/A	\$80	
ANX 30x30	\$1,545	\$1,699	\$1,777	15%	N/A	\$112	\$134	\$163	\$338	N/A	\$80	
ANX 36x36	\$1,668	\$1,834	\$1,918	15%	N/A	\$112	\$134	\$163	\$338	N/A	\$80	
ANX 42x42	\$2,121	\$2,333	\$2,439	15%	N/A	\$112	\$134	\$163	N/A	N/A	\$80	
ROUND (RND)												
ANX 30	\$1,456	\$1,601	\$1,674	15%	N/A	\$112	\$134	\$163	\$338	N/A	\$80	
ANX 36	\$1,916	\$2,108	\$2,203	15%	N/A	\$112	\$134	\$163	\$338	N/A	\$80	
ANX 42	\$2,609	\$2,870	\$3,001	15%	N/A	\$112	\$134	\$163	\$338	N/A	\$80	
ANX 48	\$3,238	\$3,562	\$3,724	15%	N/A	\$112	\$134	\$163	N/A	N/A	\$80	
ANX 54	\$3,976	\$4,174	\$4,572	15%	N/A	N/A	\$134	\$163	N/A	N/A	\$80	
RECTANGLE (REC)												
AN1 18x48	\$1,616	\$1,778	\$1,859	15%	\$389	N/A	\$134	\$163	N/A	N/A	\$133	
AN1 18x60	\$1,894	\$2,084	\$2,178	15%	\$389	N/A	\$134	\$163	N/A	N/A	\$133	
AN1 18x72	\$2,179	\$2,397	\$2,506	15%	\$389	N/A	\$134	\$163	N/A	N/A	\$133	
AN1 18x84	\$2,749	\$3,024	\$3,162	15%	\$389	N/A	\$134	\$163	N/A	N/A	\$133	
AN1 18x96	\$2,749	\$3,024	\$3,162	15%	\$389	N/A	\$134	\$163	N/A	N/A	\$133	
AN1 24x48	\$1,623	\$1,785	\$1,866	15%	\$389	N/A	\$134	\$163	N/A	\$711	\$133	
ANX 24x48 (ANX2339-2)	\$1,576	\$1,734	\$1,812	15%	N/A	N/A	\$268	N/A	N/A	N/A	\$265	
AN1 24x60	\$1,901	\$2,091	\$2,186	15%	\$389	N/A	\$134	\$163	N/A	\$711	\$133	
AN1 24x72	\$2,186	\$2,404	\$2,514	15%	\$389	N/A	\$134	\$163	N/A	\$711	\$133	
AN1 24x84	\$2,756	\$3,031	\$3,169	15%	\$389	N/A	\$134	\$163	N/A	N/A	\$133	
AN1 24x96	\$2,756	\$3,031	\$3,169	15%	\$389	N/A	\$134	\$163	N/A	N/A	\$133	
AN1 30x36	\$1,558	\$1,714	\$1,792	15%	\$389	N/A	\$134	\$163	N/A	\$711	\$133	
AN1 30x42	\$1,763	\$1,939	\$2,027	15%	\$389	N/A	\$134	\$163	N/A	\$711	\$133	
AN1 30x48	\$1,901	\$2,092	\$2,187	15%	\$389	N/A	\$134	\$163	N/A	\$711	\$133	
ANX 30x48 (ANX2639-2)	\$1,773	\$1,950	\$2,039	15%	N/A	N/A	\$268	N/A	N/A	N/A	\$265	
AN1 30x60	\$2,252	\$2,478	\$2,590	15%	\$389	N/A	\$134	\$163	N/A	\$711	\$133	
AN1 30x72	\$2,603	\$2,863	\$2,994	15%	\$389	N/A	\$134	\$163	N/A	\$711	\$133	
AN1 30x84	\$3,305	\$3,635	\$3,801	15%	\$389	N/A	\$134	\$163	N/A	N/A	\$133	
AN1 30x96	\$3,305	\$3,635	\$3,801	15%	\$389	N/A	\$134	\$163	N/A	N/A	\$133	
AN1 36x48	\$2,187	\$2,405	\$2,514	15%	\$389	N/A	\$134	\$163	N/A	N/A	\$133	
AN1 36x60	\$2,603	\$2,863	\$2,994	15%	\$389	N/A	\$134	\$163	N/A	N/A	\$133	
AN1 36x72	\$3,020	\$3,322	\$3,473	15%	\$389	N/A	\$134	\$163	N/A	N/A	\$133	
AN1 36x84	\$3,860	\$4,246	\$4,439	15%	\$389	N/A	\$134	\$163	N/A	N/A	\$133	
AN1 36x96	\$3,860	\$4,246	\$4,439	15%	\$389	N/A	\$134	\$163	N/A	N/A	\$133	
AN2 42x48	\$2,973	\$3,270	\$3,418	15%	N/A	N/A	\$134	\$163	N/A	N/A	\$228	
AN2 42x60	\$3,462	\$3,808	\$3,982	15%	N/A	N/A	\$134	\$163	N/A	N/A	\$228	
AN2 42x72	\$3,705	\$4,075	\$4,260	15%	N/A	N/A	\$134	\$163	N/A	N/A	\$228	
AN2 42x84	\$4,155	\$4,570	\$4,778	15%	N/A	N/A	\$134	\$163	N/A	N/A	\$228	
AN2 42x96	\$4,155	\$4,570	\$4,778	15%	N/A	N/A	\$134	\$163	N/A	N/A	\$228	
AN2 48x60	\$3,888	\$4,277	\$4,471	15%	N/A	N/A	\$134	\$163	N/A	N/A	\$228	
AN2 48x72	\$4,444	\$4,888	\$5,110	15%	N/A	N/A	\$134	\$163	N/A	N/A	\$228	
AN2 48x84	\$5,562	\$6,118	\$6,396	15%	N/A	N/A	\$134	\$163	N/A	N/A	\$228	
AN2 48x96	\$5,562	\$6,118	\$6,396	15%	N/A	N/A	\$134	\$163	N/A	N/A	\$228	

ANYWAY TABLES - (VENEER)



		Edge Choice: Wood (Red Oak & Maple)			Wood Upgrade	OPTIONS						
		V-12	V-23	V-19	Upgrade: Walnut / Mahogany / Cherry	NESTING	FLIP-TOP	POWDERCOAT UPGRADE	DELUXE CASTERS (BLK)	CENTER MOUNT ELEC. COLUMN	ADJ. HEIGHT PIN	SPECIAL HEIGHT
		V-18	V-17	V-16								
RACETRACK (RAC)												
AN1	36x72	\$3,561	\$3,917	\$4,095	15%	\$389	N/A	\$134	\$163	N/A	N/A	\$133
AN1	36x84	\$4,394	\$4,833	\$5,053	15%	\$389	N/A	\$134	\$163	N/A	N/A	\$133
AN1	36x96	\$4,394	\$4,833	\$5,053	15%	\$389	N/A	\$134	\$163	N/A	N/A	\$133
AN2	42x96	\$6,095	\$6,705	\$7,010	15%	N/A	N/A	\$134	\$163	N/A	N/A	\$228
AN2	42x120 (1 piece)	\$8,124	\$8,936	\$9,342	15%	N/A	N/A	\$134	\$244	N/A	N/A	\$228
AN2	42x144 (1 piece)	\$9,315	\$10,246	\$10,712	15%	N/A	N/A	\$134	\$244	N/A	N/A	\$228
AN2	48x96	\$6,095	\$6,705	\$7,010	15%	N/A	N/A	\$134	\$163	N/A	N/A	\$228
AN2	48x120 (1 piece)	\$8,124	\$8,936	\$9,342	15%	N/A	N/A	\$134	\$244	N/A	N/A	\$228
AN2	48x144 (1 piece)	\$9,315	\$10,246	\$10,712	15%	N/A	N/A	\$134	\$244	N/A	N/A	\$228
BOAT (BOT)												
AN2	36x48x120 (1 piece)	\$7,327	\$8,060	\$8,426	15%	N/A	N/A	\$134	\$244	N/A	N/A	\$228
AN2	36x48x144 (1 piece)	\$7,913	\$8,704	\$9,100	15%	N/A	N/A	\$134	\$244	N/A	N/A	\$228
AN2	42x54x120 (1 piece)	\$7,693	\$8,463	\$8,847	15%	N/A	N/A	\$134	\$244	N/A	N/A	\$228
AN2	42x54x144 (1 piece)	\$8,279	\$9,107	\$9,521	15%	N/A	N/A	\$134	\$244	N/A	N/A	\$228
OVAL (OVL)												
AN1	36x60	\$3,838	\$4,222	\$4,414	15%	\$389	N/A	\$134	\$163	N/A	N/A	\$133
AN1	36x72	\$3,838	\$4,222	\$4,414	15%	\$389	N/A	\$134	\$163	N/A	N/A	\$133
AN1	36x84	\$4,949	\$5,444	\$5,692	15%	\$389	N/A	\$134	\$163	N/A	N/A	\$133
AN1	36x96	\$4,949	\$5,444	\$5,692	15%	\$389	N/A	\$134	\$163	N/A	N/A	\$133
AN2	42x72	\$5,527	\$6,080	\$6,356	15%	N/A	N/A	\$134	\$163	N/A	N/A	\$228
AN2	42x84	\$7,127	\$7,840	\$8,196	15%	N/A	N/A	\$134	\$163	N/A	N/A	\$228
AN2	42x96	\$7,127	\$7,840	\$8,196	15%	N/A	N/A	\$134	\$163	N/A	N/A	\$228
AN2	48x84	\$7,768	\$8,545	\$8,934	15%	N/A	N/A	\$134	\$163	N/A	N/A	\$228
AN2	48x96	\$6,724	\$7,396	\$7,733	15%	N/A	N/A	\$134	\$163	N/A	N/A	\$228
AN2	48x120 (1 piece)	\$9,037	\$9,941	\$10,393	15%	N/A	N/A	\$134	\$163	N/A	N/A	\$228
TRAPEZOID (TRP)												
AN1	24x24x48	\$3,089	\$3,398	\$3,552	15%	\$389	N/A	\$134	\$163	N/A	N/A	\$133
AN1	24x36x60	\$3,774	\$4,151	\$4,340	15%	\$389	N/A	\$134	\$163	N/A	N/A	\$133
AN1	30x30x60	\$3,608	\$3,969	\$4,149	15%	\$389	N/A	\$134	\$163	N/A	N/A	\$133
AN1	30x42x72	\$4,419	\$4,861	\$5,082	15%	\$389	N/A	\$134	\$163	N/A	N/A	\$133
HALF ROUND (HRD)												
AN1	24x48	\$2,913	\$3,204	\$3,350	15%	\$389	N/A	\$134	\$163	N/A	N/A	\$133
AN1	30x60	\$3,422	\$3,764	\$3,935	15%	\$389	N/A	\$134	\$163	N/A	N/A	\$133
AN1	36x72	\$3,946	\$4,340	\$4,538	15%	\$389	N/A	\$134	\$163	N/A	N/A	\$133
CRESCENT (CRT)												
AN1	24x24x48	\$3,089	\$3,398	\$3,552	15%	\$389	N/A	\$134	\$163	N/A	N/A	\$133
AN1	30x30x60	\$3,608	\$3,969	\$4,149	15%	\$389	N/A	\$134	\$163	N/A	N/A	\$133

CORE



CORE

Core Tables were developed as a different way to build a Parsons table. Created using a mix of materials of steel along with laminate or wood, the Core table offers the ability to create more interesting finish options for your space. In addition to the creative aspect of the product, by using a steel structure, Core can achieve greater lengths of table sizes compared to other tables in the market. And, because it ships knocked down, it can more easily be delivered into a building and then assembled once in the final location.

Table Specifications

Finishes: Available in 40+ standard powder coat finishes. Custom finishes available. Contact Customer Service for a quote.

Construction: Top is supported with a four leg steel frame. Frame is structurally supported to provide reinforcement and the ability to span large distances.

Top Surface: Comes as standard in a ¾" thick laminate with either self edge or 1mm (limited to 19 colors) pvc edge band. Tops are also available in solid surface along with wood veneer (limited selection) or stone. *Please note on stone tops there may be limitations to the size of the table based on the weight of the top. Contact customer service to review your requirements.*

End Panels are available in laminate, veneer, and solid surface (slab end only for solid surface). We do not offer stone end panels as an option.

Glides: All tables are equipped with 1" diameter glides with stainless steel cover. The glide is suitable for carpet as well as hard floors.

Electrical Options: Available with either our Villa or Cove electrical units, they are offered in predetermined locations as a standard. If you don't see the electrical configuration you like or don't want it in the standard position, no problem, just contact Customer Service to come up with your solution.

See "Electrical Placement" section for standard placement of electrical.

Warranty: Berco warrants its manufactured products are free of defects in design, material and workmanship for as long as the original purchaser owns them. For self edge laminate products, the warranty on the self edge is one year. Millwork items carry a five year warranty. See our warranty page for a full explanation.

CORE – END STORAGE COMPONENTS

End Units: Designed for the end of a Standing Height Table, these units come in 36" and 42" widths. Below are standard options. If you don't see something you need, please contact Customer Service for a quote.

Cubbies



Open With Adjustable Shelves

- 4 adjustable shelves



Coat Cabinet – No Doors

- Includes coat hooks



CORE – END STORAGE COMPONENTS

Double Doors With Adjustable Shelves

- 4 adjustable shelves



Double Trash Bin

- Optional trash can liner available



Electrical Placement

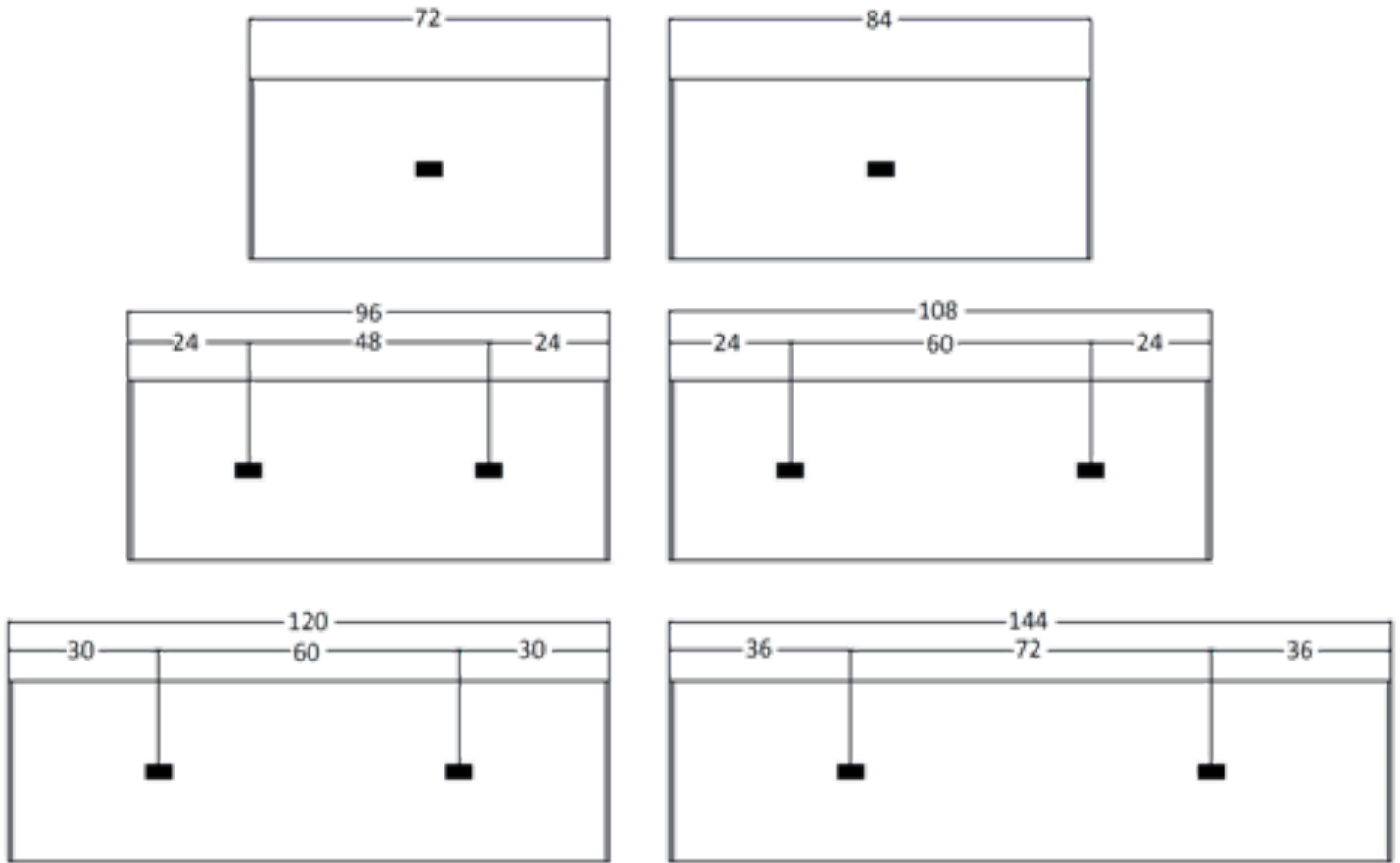

End Panel Options

OPEN END

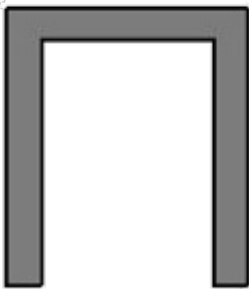

SLAB END



CORE ELECTRICAL/DATA OPTIONS

Single Electrical Corded Units

VILLA



CONFIGURATION	MODEL	COLOR	LIST
2 OUTLETS ONLY	PVC108-P	BLACK, WHITE, SILVER	\$294.00
2 OUTLETS 2 DATA	PVC108-PD	BLACK, WHITE, SILVER	\$351.00

COVE



CONFIGURATION	MODEL	COLOR	LIST
2 OUTLETS ONLY	COV108-P2	BLACK, WHITE, SILVER	\$383.00
2 OUTLETS 2 USB	COV108-P2U2	BLACK, WHITE, SILVER	\$575.00
4 OUTLETS 2 USB	COV108-P4U2	BLACK, WHITE, SILVER	\$734.00
6 OUTLETS 4 USB	COV108-P6U4	BLACK, WHITE, SILVER	\$1,085.00

Under Table Wire Manager

WMC (BLACK PLASTIC)



CONFIGURATION	MODEL	COLOR	LIST
72" TABLE LENGTH	WMC-6	BLACK	\$94.00
84" TABLE LENGTH	WMC-7	BLACK	\$104.00
96" TABLE LENGTH	WMC-8	BLACK	\$109.00
108" TABLE LENGTH	WMC-9	BLACK	\$120.00
144" TABLE LENGTH	WMC-12	BLACK	\$130.00

WMF (BLACK FELT)



CONFIGURATION	MODEL	COLOR	LIST
72" TABLE LENGTH	WMF-6	BLACK	\$94.00
84" TABLE LENGTH	WMF-7	BLACK	\$104.00
96" TABLE LENGTH	WMF-8	BLACK	\$109.00
108" TABLE LENGTH	WMF-9	BLACK	\$120.00
144" TABLE LENGTH	WMF-12	BLACK	\$130.00

CORE - SEATED HEIGHT (30")	CORE - COUNTER HEIGHT (36")
-----------------------------------	------------------------------------



	Seated Height (30")	Laminate Upgrades		OPTIONS		Counter Height (36")	Laminate Upgrades		OPTIONS	
		Laminate Upgrade I	Laminate Upgrade II	SLAB ENDS (2)	CUSTOM POWDER COAT		Laminate Upgrade I	Laminate Upgrade II	SLAB ENDS (2)	CUSTOM POWDER COAT
		ADD	ADD	ADD	ADD		ADD	ADD	ADD	ADD
RECTANGLE (REC)										
24x60	\$5,255	\$263	\$1,051	\$591	\$236	\$5,397	\$270	\$1,079	\$591	\$236
24x72	\$5,386	\$269	\$1,077	\$591	\$236	\$5,530	\$277	\$1,106	\$591	\$236
24x84	\$5,495	\$275	\$1,099	\$591	\$236	\$5,639	\$282	\$1,129	\$591	\$236
24x96	\$5,550	\$278	\$1,110	\$591	\$236	\$5,695	\$285	\$1,139	\$591	\$236
24x120	\$6,334	\$317	\$1,267	\$591	\$236	\$6,478	\$322	\$1,296	\$591	\$236
24x144	\$6,599	\$330	\$1,320	\$591	\$236	\$6,743	\$337	\$1,349	\$591	\$236
30x60	\$5,363	\$268	\$1,073	\$591	\$236	\$5,507	\$275	\$1,101	\$591	\$236
30x72	\$5,496	\$275	\$1,099	\$591	\$236	\$5,639	\$282	\$1,129	\$591	\$236
30x84	\$5,608	\$280	\$1,122	\$591	\$236	\$5,743	\$288	\$1,151	\$591	\$236
30x96	\$5,664	\$283	\$1,133	\$591	\$236	\$5,799	\$291	\$1,162	\$591	\$236
30x120	\$6,463	\$323	\$1,293	\$591	\$236	\$6,600	\$330	\$1,322	\$591	\$236
30x144	\$6,734	\$337	\$1,347	\$591	\$236	\$6,881	\$344	\$1,376	\$591	\$236
36x60	\$5,472	\$274	\$1,094	\$591	\$236	\$5,619	\$281	\$1,124	\$591	\$236
36x72	\$5,608	\$280	\$1,122	\$591	\$236	\$5,758	\$288	\$1,152	\$591	\$236
36x84	\$5,722	\$286	\$1,144	\$591	\$236	\$5,872	\$294	\$1,174	\$591	\$236
36x96	\$5,779	\$289	\$1,156	\$591	\$236	\$5,929	\$296	\$1,186	\$591	\$236
36x120	\$6,595	\$330	\$1,319	\$591	\$236	\$6,745	\$337	\$1,349	\$591	\$236
36x144	\$6,871	\$344	\$1,373	\$591	\$236	\$7,021	\$351	\$1,404	\$591	\$236
42x60	\$5,584	\$279	\$1,101	\$591	\$236	\$5,734	\$287	\$1,147	\$591	\$236
42x72	\$5,641	\$282	\$1,112	\$591	\$236	\$5,791	\$290	\$1,158	\$591	\$236
42x84	\$5,759	\$287	\$1,134	\$591	\$236	\$5,909	\$295	\$1,182	\$591	\$236
42x96	\$5,816	\$290	\$1,145	\$591	\$236	\$5,966	\$298	\$1,193	\$591	\$236
42x120	\$6,636	\$331	\$1,327	\$591	\$236	\$6,786	\$339	\$1,357	\$591	\$236
42x144	\$6,917	\$345	\$1,381	\$591	\$236	\$7,067	\$353	\$1,413	\$591	\$236
48x60 (SLAB END ONLY)	\$6,511	\$329	\$1,317	incl.	\$236	\$6,734	\$337	\$1,347	incl.	\$236
48x72 (SLAB END ONLY)	\$6,629	\$332	\$1,328	incl.	\$236	\$6,791	\$340	\$1,358	incl.	\$236
48x84 (SLAB END ONLY)	\$6,747	\$338	\$1,352	incl.	\$236	\$6,909	\$345	\$1,382	incl.	\$236
48x96 (SLAB END ONLY)	\$6,816	\$341	\$1,363	incl.	\$236	\$6,966	\$348	\$1,393	incl.	\$236
48x120 (SLAB END ONLY)	\$7,636	\$382	\$1,527	incl.	\$236	\$7,786	\$389	\$1,557	incl.	\$236
48x144 (SLAB END ONLY)	\$7,917	\$396	\$1,583	incl.	\$236	\$8,067	\$403	\$1,613	incl.	\$236
CUSTOM HEIGHT (Max 42"H)										
\$1,000 Per Table Upcharge										
CABINETRY - END OF TABLE										
Cubbies	Call For Price					Call For Price				
Open Adjustable Shelves	Call For Price					Call For Price				
Coat Cabinet - No Doors	Call For Price					Call For Price				
Double Doors With Adj. Shelves	Call For Price					Call For Price				
Double Trash Bin (no trash liners)	Call For Price					Call For Price				

CONTACT FACTORY FOR CURRENT PRICING

CORE - STANDING HEIGHT (42")



	Standing Height (42")	Laminate Upgrades		OPTIONS	
		Laminate Upgrade I	Laminate Upgrade II	SLAB ENDS (2)	CUSTOM POWDER
		ADD	ADD	ADD	ADD
RECTANGLE (REC)					
24x60	\$5,538	\$277	\$1,108		\$236
24x72	\$5,674	\$284	\$1,135		\$236
24x84	\$5,784	\$289	\$1,157		\$236
24x96	\$5,839	\$292	\$1,166		\$236
24x120	\$6,622	\$331	\$1,377	\$591	\$236
24x144	\$6,887	\$344	\$1,434	\$591	\$236
30x60	\$5,651	\$283	\$1,108	\$591	\$236
30x72	\$5,790	\$290	\$1,135	\$591	\$236
30x84	\$5,902	\$295	\$1,157	\$591	\$236
30x96	\$5,958	\$298	\$1,166	\$591	\$236
30x120	\$6,757	\$338	\$1,377	\$591	\$236
30x144	\$7,028	\$351	\$1,434	\$591	\$236
36x60	\$5,766	\$283	\$1,108	\$591	\$236
36x72	\$5,908	\$290	\$1,135	\$591	\$236
36x84	\$6,022	\$295	\$1,157	\$591	\$236
36x96	\$6,079	\$298	\$1,166	\$591	\$236
36x120	\$6,895	\$338	\$1,377	\$591	\$236
36x144	\$7,171	\$344	\$1,434	\$591	\$236
42x60	\$5,884	\$306	\$1,177	\$591	\$236
42x72	\$5,941	\$307	\$1,188	\$591	\$236
42x84	\$6,059	\$303	\$1,212	\$591	\$236
42x96	\$6,116	\$306	\$1,223	\$591	\$236
42x120	\$6,936	\$347	\$1,387	\$591	\$236
42x144	\$7,217	\$361	\$1,443	\$591	\$236
48x60 (SLAB END ONLY)	\$6,884	\$344	\$1,377	incl.	\$236
48x72 (SLAB END ONLY)	\$6,941	\$347	\$1,388	incl.	\$236
48x84 (SLAB END ONLY)	\$7,059	\$353	\$1,412	incl.	\$236
48x96 (SLAB END ONLY)	\$7,116	\$356	\$1,423	incl.	\$236
48x120 (SLAB END ONLY)	\$7,936	\$397	\$1,587	incl.	\$236
48x144 (SLAB END ONLY)	\$8,217	\$411	\$1,643	incl.	\$236
CUSTOM HEIGHT (Max 42"H)					
\$1,000 Per Table Upcharge					
CABINERY - END OF TABLE					
Cubbies	Call For Price				
Open Adjustable Shelves	Call For Price				
Coat Cabinet - No Doors	Call For Price				
Double Doors With Adj. Shelves	Call For Price				
Double Trash Bin (no trash liners)	Call For Price				

CONTACT FACTORY FOR CURRENT PRICING

CORE - SEATED HEIGHT (30")	CORE - COUNTER HEIGHT (36")
<i>SOLID SURFACE</i>	<i>SOLID SURFACE</i>



RECTANGLE (REC)

	LG SOLID SURFACE				OPTIO N	LG SOLID SURFACE				OPTION
	GRADE A	GRADE B	GRADE C	GRADE D	CUSTOM POWDER COAT	GRADE A	GRADE B	GRADE C	GRADE D	CUSTOM POWDER COAT
					ADD					ADD
24x60 (SLAB END ONLY)	\$7,206	\$7,603	\$8,116	\$8,629	\$236	\$7,493	\$7,952	\$8,543	\$9,135	\$236
24x72 (SLAB END ONLY)	\$7,340	\$7,768	\$8,320	\$8,873	\$236	\$7,585	\$8,065	\$8,683	\$9,301	\$236
24x84 (SLAB END ONLY)	\$7,474	\$7,933	\$8,524	\$9,116	\$236	\$7,719	\$8,229	\$8,877	\$9,544	\$236
24x96 (SLAB END ONLY)	\$7,566	\$8,046	\$8,664	\$9,282	\$236	\$7,812	\$8,312	\$8,926	\$9,710	\$236
24x120 (SLAB END ONLY)	\$9,412	\$9,942	\$10,626	\$11,310	\$236	\$9,699	\$10,269	\$11,053	\$11,816	\$236
24x144 (SLAB END ONLY)	\$9,680	\$10,271	\$11,034	\$11,797	\$236	\$9,925	\$10,535	\$11,396	\$12,225	\$236
30x60 (SLAB END ONLY)	\$7,663	\$8,162	\$8,807	\$9,451	\$236	\$7,998	\$8,529	\$9,305	\$10,042	\$236
30x72 (SLAB END ONLY)	\$7,800	\$8,330	\$9,014	\$9,698	\$236	\$8,132	\$8,737	\$9,513	\$10,289	\$236
30x84 (SLAB END ONLY)	\$7,979	\$8,550	\$9,286	\$10,023	\$236	\$8,311	\$8,901	\$9,717	\$10,532	\$236
30x96 (SLAB END ONLY)	\$8,116	\$8,718	\$9,494	\$10,270	\$236	\$8,490	\$9,069	\$9,924	\$10,779	\$236
30x120 (SLAB END ONLY)	\$10,006	\$10,669	\$11,524	\$12,378	\$236	\$10,241	\$11,075	\$12,022	\$12,969	\$236
30x144 (SLAB END ONLY)	\$10,322	\$11,056	\$12,003	\$12,950	\$236	\$10,612	\$11,408	\$12,434	\$13,459	\$236
36x60 (SLAB END ONLY)	\$8,157	\$8,759	\$9,535	\$10,311	\$236	\$8,522	\$9,206	\$10,087	\$10,968	\$236
36x72 (SLAB END ONLY)	\$8,340	\$8,982	\$9,811	\$10,639	\$236	\$8,704	\$9,428	\$10,362	\$11,296	\$236
36x84 (SLAB END ONLY)	\$8,518	\$9,202	\$10,083	\$10,964	\$236	\$8,883	\$9,648	\$10,634	\$11,620	\$236
36x96 (SLAB END ONLY)	\$8,700	\$9,424	\$10,358	\$11,299	\$236	\$9,024	\$9,819	\$10,845	\$11,871	\$236
36x120 (SLAB END ONLY)	\$10,623	\$11,419	\$12,445	\$13,512	\$236	\$11,003	\$11,880	\$13,011	\$14,142	\$236
36x144 (SLAB END ONLY)	\$10,984	\$11,861	\$12,990	\$14,223	\$236	\$11,364	\$12,323	\$13,559	\$14,795	\$236
42x60 (SLAB END ONLY)	\$8,599	\$9,303	\$10,157	\$11,118	\$236	\$9,027	\$9,823	\$10,848	\$11,874	\$236
42x72 (SLAB END ONLY)	\$8,785	\$9,529	\$10,427	\$11,449	\$236	\$9,209	\$10,046	\$11,124	\$12,202	\$236
42x84 (SLAB END ONLY)	\$9,008	\$9,800	\$10,747	\$11,855	\$236	\$9,432	\$10,320	\$11,464	\$12,608	\$236
42x96 (SLAB END ONLY)	\$9,190	\$10,015	\$11,005	\$12,183	\$236	\$9,618	\$10,546	\$11,743	\$12,939	\$236
42x120 (SLAB END ONLY)	\$11,217	\$12,141	\$13,342	\$14,539	\$236	\$11,683	\$12,713	\$14,041	\$15,369	\$236
42x144 (SLAB END ONLY)	\$11,664	\$12,648	\$14,022	\$15,350	\$236	\$12,092	\$13,214	\$14,660	\$16,107	\$236
48x60 (SLAB END ONLY)	\$9,017	\$9,813	\$10,839	\$11,864	\$236	\$9,531	\$10,439	\$11,609	\$12,779	\$236
48x72 (SLAB END ONLY)	\$9,200	\$10,142	\$11,247	\$12,351	\$236	\$9,758	\$10,717	\$11,953	\$13,189	\$236
48x84 (SLAB END ONLY)	\$9,383	\$10,420	\$11,590	\$12,760	\$236	\$9,984	\$10,994	\$12,296	\$13,598	\$236
48x96 (SLAB END ONLY)	\$9,739	\$10,698	\$11,934	\$13,170	\$236	\$10,211	\$11,272	\$12,640	\$14,007	\$236
48x120 (SLAB END ONLY)	\$11,811	\$12,872	\$14,239	\$15,607	\$236	\$12,324	\$13,497	\$15,010	\$16,522	\$236
48x144 (SLAB END ONLY)	\$12,305	\$13,478	\$14,991	\$16,503	\$236	\$12,778	\$14,053	\$15,697	\$17,340	\$236

CONTACT FACTORY FOR CURRENT PRICING

CORE - STANDING HEIGHT (42")
SOLID SURFACE



RECTANGLE (REC)

	LG SOLID SURFACE				OPTIO
	GRADE A	GRADE B	GRADE C	GRADE D	N CUSTOM POWDER COAT ADD
24x60 (SLAB END ONLY)	\$7,794	\$8,304	\$8,962	\$9,611	\$236
24x72 (SLAB END ONLY)	\$7,887	\$8,418	\$9,101	\$9,750	\$236
24x84 (SLAB END ONLY)	\$8,021	\$8,582	\$9,305	\$10,017	\$236
24x96 (SLAB END ONLY)	\$8,155	\$8,747	\$9,509	\$10,271	\$236
24x120 (SLAB END ONLY)	\$10,000	\$10,643	\$11,471	\$12,191	\$236
24x144 (SLAB END ONLY)	\$10,227	\$10,921	\$11,815	\$12,577	\$236
30x60 (SLAB END ONLY)	\$8,344	\$8,976	\$9,792	\$10,477	\$236
30x72 (SLAB END ONLY)	\$8,481	\$9,144	\$9,999	\$10,754	\$236
30x84 (SLAB END ONLY)	\$8,660	\$9,364	\$10,272	\$11,079	\$236
30x96 (SLAB END ONLY)	\$8,798	\$9,532	\$10,426	\$11,146	\$236
30x120 (SLAB END ONLY)	\$10,687	\$11,483	\$12,354	\$13,534	\$236
30x144 (SLAB END ONLY)	\$11,003	\$11,870	\$12,816	\$14,106	\$236
36x60 (SLAB END ONLY)	\$8,958	\$9,723	\$10,577	\$11,695	\$236
36x72 (SLAB END ONLY)	\$9,099	\$9,894	\$10,782	\$11,946	\$236
36x84 (SLAB END ONLY)	\$9,277	\$10,114	\$11,012	\$12,270	\$236
36x96 (SLAB END ONLY)	\$9,460	\$10,337	\$11,268	\$12,599	\$236
36x120 (SLAB END ONLY)	\$11,439	\$12,359	\$13,634	\$14,870	\$236
36x144 (SLAB END ONLY)	\$11,799	\$12,815	\$14,181	\$15,522	\$236
42x60 (SLAB END ONLY)	\$9,507	\$10,339	\$11,539	\$12,683	\$236
42x72 (SLAB END ONLY)	\$9,693	\$10,563	\$11,818	\$13,014	\$236
42x84 (SLAB END ONLY)	\$9,916	\$10,787	\$12,158	\$13,420	\$236
42x96 (SLAB END ONLY)	\$10,139	\$11,011	\$12,498	\$13,826	\$236
42x120 (SLAB END ONLY)	\$12,167	\$13,099	\$14,735	\$16,182	\$236
42x144 (SLAB END ONLY)	\$12,572	\$13,506	\$15,351	\$16,916	\$236
48x60 (SLAB END ONLY)	\$10,059	\$10,869	\$12,371	\$13,673	\$236
48x72 (SLAB END ONLY)	\$10,281	\$11,134	\$12,715	\$14,082	\$236
48x84 (SLAB END ONLY)	\$10,504	\$11,357	\$13,123	\$14,569	\$236
48x96 (SLAB END ONLY)	\$10,727	\$11,580	\$13,466	\$14,978	\$236
48x120 (SLAB END ONLY)	\$12,755	\$14,128	\$15,772	\$17,415	\$236
48x144 (SLAB END ONLY)	\$13,160	\$14,735	\$16,523	\$18,312	\$236

CONTACT FACTORY FOR CURRENT PRICING

DISCUS



DISCUS

The classic flat Discus base provides a non-intrusive place for the eye (and foot) to rest. Perfect for dining facilities or meeting rooms, Discus adds a timeless, elegant look to your space. Discus tables have 6 adjustable glides, ideal for placing tables together, even on uneven surfaces.

Pedestal Specifications:

Finishes: Available in 40+ standard powder coat finishes. Chrome plated finishes are offered at an additional charge. Our unique mechanical construction enables a flawless seam when mixing column finishes with any base finish. Custom finishes available. Please contact Customer Service for quotation.

Glides and Casters: All Discus bases come with 6 adjustable 1" diameter stainless steel glides. CASTERS NOT AVAILABLE.

Pedestal Specifications

Flat-shaped base features 18 gauge spun steel with a specially designed weight for maximum stability. 3" and 4" columns are 16 gauge. All columns are welded flash controlled steel tubing square cut to insure levelness. Cast iron spiders are machined for column recess and bolted with 1/2"-13 steel threaded rod.

Discus Table Options

There are several options available on Discus including:

- Flip Top
- Center Mount Electrical Column
- Floor Access Electrical Column
- Special Height

DISCUS BASE SPECIFICATIONS

	<u>Smart Code</u>	<u>Base Size</u>	<u>Column Diameter</u>	<u>Top Capacity</u>
	DSX-18X	18"	3"	24" SQ & RND
	DSX-22X	22"	3"	30" SQ & 36" RND
	DSX-28X	28"	4"	42" SQ & 60" RND

DISCUS TABLES - (LAMINATE - PVC EDGE)



Edge Choice: PVC & T-Mold				Laminate Upgrades		Light Weight	OPTIONS								
T-15		L-21		P-14	PK-2	Laminate Upgrade I	Laminate Upgrade II	Light Weight (PVC only - 1" top)	FLIP-TOP	POWDERCOAT UPGRADE	CHROME	CENTER MOUNT ELEC.	FLOOR ACCESS ELEC. COLUMN	SPECIAL HEIGHT	
P-10 (self)		P-12		PK-4	ADD										ADD
L-15					L-23										
SQUARE (SQR)															
DSX	24x24	\$900	\$945	\$990	\$67	\$180	\$157	\$112	\$134	\$271	\$338	\$541	\$80		
DSX	30x30	\$1,052	\$1,105	\$1,157	\$79	\$210	\$184	\$112	\$134	\$271	\$338	\$541	\$80		
DSX	36x36	\$1,350	\$1,418	\$1,485	\$101	\$270	\$236	\$112	\$134	\$271	\$338	\$541	\$80		
DSX	42x42	\$1,457	\$1,530	\$1,603	\$109	\$291	\$255	\$112	\$134	\$271	\$338	\$541	\$80		
DSX	48x48	\$1,574	\$1,652	\$1,731	\$118	\$315	\$275	N/A	\$134	\$271	N/A	\$541	\$80		
ROUND (RND)															
DSX	24	\$931	\$977	\$1,024	\$70	\$186	\$163	\$112	\$134	\$271	\$338	\$541	\$80		
DSX	30	\$1,079	\$1,133	\$1,187	\$81	\$216	\$189	\$112	\$134	\$271	\$338	\$541	\$80		
DSX	36	\$1,169	\$1,227	\$1,286	\$88	\$234	\$205	\$112	\$134	\$271	\$338	\$541	\$80		
DSX	42	\$1,478	\$1,551	\$1,625	\$111	\$296	\$259	\$112	\$134	\$271	\$338	\$541	\$80		
DSX	48	\$1,595	\$1,675	\$1,754	\$120	\$319	\$279	\$112	\$134	\$271	\$338	\$541	\$80		
DSX	54	\$1,726	\$1,812	\$1,899	\$129	\$345	\$302	N/A	\$134	\$271	N/A	N/A	\$80		
DSX	60	\$1,899	\$1,994	\$2,089	\$142	\$380	\$332	N/A	\$134	\$271	N/A	N/A	\$80		
RECTANGLE (REC)															
DSX2	24x60 (2 bases)	\$1,705	\$1,790	\$1,875	\$128	\$341	\$298	N/A	\$268	\$542	N/A	N/A	\$161		
DSX2	24x72 (2 bases)	\$1,777	\$1,866	\$1,955	\$133	\$355	\$311	N/A	\$268	\$542	N/A	N/A	\$161		
DSX2	30x60 (2 bases)	\$1,930	\$2,026	\$2,123	\$145	\$386	\$338	N/A	\$268	\$542	N/A	N/A	\$161		
DSX2	30x72 (2 bases)	\$1,939	\$2,036	\$2,133	\$145	\$388	\$339	N/A	\$268	\$542	N/A	N/A	\$161		
DSX2	36x48 (2 bases)	\$2,319	\$2,434	\$2,550	\$174	\$464	\$406	N/A	\$268	\$542	N/A	N/A	\$161		
DSX2	36x60 (2 bases)	\$2,418	\$2,539	\$2,660	\$181	\$484	\$423	N/A	\$268	\$542	N/A	N/A	\$161		
DSX2	36x72 (2 bases)	\$2,518	\$2,644	\$2,770	\$189	\$504	\$441	N/A	\$268	\$542	N/A	N/A	\$161		

DISCUS TABLES - (LAMINATE - WOOD EDGE)



	Edge Choice: Wood (Red Oak & Maple)			Wood Upgrade	OPTIONS					
	W-12	W-23 W-18 W-16	W-19 W-17 W-32	Upgrade: Walnut / Mahogany / Cherry	FLIP-TOP	POWDERCOAT UPGRADE	CHROME	CENTER MOUNT ELEC. COLUMN	FLOOR ACCESS ELEC. COLUMN	SPECIAL HEIGHT
				ADD	ADD	ADD	ADD	ADD	ADD	ADD
SQUARE (SQR)										
DSX 24x24	\$1,349	\$1,574	\$1,799	15%	\$112	\$134	\$271	\$338	\$541	\$80
DSX 30x30	\$1,578	\$1,841	\$2,104	15%	\$112	\$134	\$271	\$338	\$541	\$80
DSX 36x36	\$2,025	\$2,363	\$2,701	15%	\$112	\$134	\$271	\$338	\$541	\$80
DSX 42x42	\$2,732	\$3,278	\$3,643	15%	\$112	\$134	\$271	\$338	\$541	\$80
DSX 48x48	\$3,278	\$3,934	\$4,371	15%	N/A	\$134	\$271	N/A	\$541	\$80
ROUND (RND)										
DSX 24	\$1,396	\$1,628	\$1,861	15%	\$112	\$134	\$271	\$338	\$541	\$80
DSX 30	\$1,619	\$1,889	\$2,159	15%	\$112	\$134	\$271	\$338	\$541	\$80
DSX 36	\$1,753	\$2,045	\$2,338	15%	\$112	\$134	\$271	\$338	\$541	\$80
DSX 42	\$2,770	\$3,325	\$3,694	15%	\$112	\$134	\$271	\$338	\$541	\$80
DSX 48	\$2,990	\$3,588	\$3,987	15%	\$112	\$134	\$271	\$338	\$541	\$80
DSX 54	\$3,236	\$3,884	\$4,315	15%	N/A	\$134	\$271	N/A	N/A	\$80
DSX 60	\$3,560	\$4,272	\$4,747	15%	N/A	\$134	\$271	N/A	N/A	\$80
RECTANGLE (REC)										
DSX2 24x60 (2 bases)	\$2,231	\$2,610	\$3,012	15%	N/A	\$268	\$542	N/A	N/A	\$161
DSX2 24x72 (2 bases)	\$2,375	\$2,778	\$3,206	15%	N/A	\$268	\$542	N/A	N/A	\$161
DSX2 30x60 (2 bases)	\$2,533	\$2,964	\$3,420	15%	N/A	\$268	\$542	N/A	N/A	\$161
DSX2 30x72 (2 bases)	\$2,552	\$2,986	\$3,445	15%	N/A	\$268	\$542	N/A	N/A	\$161
DSX2 36x48 (2 bases)	\$2,900	\$3,393	\$3,915	15%	N/A	\$268	\$542	N/A	N/A	\$161
DSX2 36x60 (2 bases)	\$3,100	\$3,627	\$4,185	15%	N/A	\$268	\$542	N/A	N/A	\$161
DSX2 36x72 (2 bases)	\$3,300	\$3,860	\$4,454	15%	N/A	\$268	\$542	N/A	N/A	\$161

DISCUS TABLES - (VENEER)



Edge Choice: Wood (Red Oak & Maple)				Wood Upgrade	OPTIONS						
V-12	V-23	V-19		Upgrade: Walnut / Mahogany / Cherry	FLIP-TOP	POWDERCOAT UPGRADE	CHROME	CENTER MOUNT ELEC. COLUMN	FLOOR ACCESS ELEC. COLUMN	SPECIAL HEIGHT	
	V-18	V-17		ADD	ADD	ADD	ADD	ADD	ADD	ADD	
	V-16	V-32									
SQUARE (SQR)											
DSX 24x24	\$1,392	\$1,531	\$1,601	15%	\$112	\$134	\$271	\$338	\$541	\$80	
DSX 30x30	\$1,849	\$2,034	\$2,126	15%	\$112	\$134	\$271	\$338	\$541	\$80	
DSX 36x36	\$2,552	\$2,807	\$2,934	15%	\$112	\$134	\$271	\$338	\$541	\$80	
DSX 42x42	\$3,096	\$3,405	\$3,560	15%	\$112	\$134	\$271	\$338	\$541	\$80	
DSX 48x48	\$3,715	\$4,086	\$4,272	15%	N/A	\$134	\$271	N/A	\$541	\$80	
ROUND (RND)											
DSX 24	\$1,515	\$1,666	\$1,742	15%	\$112	\$134	\$271	\$338	\$541	\$80	
DSX 30	\$2,051	\$2,256	\$2,358	15%	\$112	\$134	\$271	\$338	\$541	\$80	
DSX 36	\$2,603	\$2,864	\$2,994	15%	\$112	\$134	\$271	\$338	\$541	\$80	
DSX 42	\$3,508	\$3,859	\$4,034	15%	\$112	\$134	\$271	\$338	\$541	\$80	
DSX 48	\$4,263	\$4,689	\$4,902	15%	\$112	\$134	\$271	\$338	\$541	\$80	
DSX 54	\$5,123	\$5,635	\$5,891	15%	N/A	\$134	\$271	N/A	N/A	\$80	
DSX 60	\$6,147	\$6,762	\$7,069	15%	N/A	\$134	\$271	N/A	N/A	\$80	
RECTANGLE (REC)											
DSX2 24x60 (2 bases)	\$2,598	\$2,858	\$2,988	15%	N/A	\$268	\$542	N/A	N/A	\$161	
DSX2 24x72 (2 bases)	\$2,883	\$3,171	\$3,316	15%	N/A	\$268	\$542	N/A	N/A	\$161	
DSX2 30x60 (2 bases)	\$3,074	\$3,381	\$3,535	15%	N/A	\$268	\$542	N/A	N/A	\$161	
DSX2 30x72 (2 bases)	\$3,425	\$3,767	\$3,939	15%	N/A	\$268	\$542	N/A	N/A	\$161	
DSX2 36x48 (2 bases)	\$3,419	\$3,761	\$3,932	15%	N/A	\$268	\$542	N/A	N/A	\$161	
DSX2 36x60 (2 bases)	\$3,836	\$4,219	\$4,411	15%	N/A	\$268	\$542	N/A	N/A	\$161	
DSX2 36x72 (2 bases)	\$4,253	\$4,678	\$4,890	15%	N/A	\$268	\$542	N/A	N/A	\$161	

ENCORE



ENCORE

The Encore table series was designed as a cost-effective Parson's table with nice aesthetic details. Starting with the ability to use any laminate for greater design flexibility, then having mitered corners to make an incredibly clean aesthetic with the laminate matching up at the corners. The Encore is a perfect table for conference, dining, meeting, café, and library applications.

CONSTRUCTION:

The inner skeleton of the Encore is comprised of ¾" multi-ply hardwood frames that extend from the bottom of one end panel, across the entire bottom of the table top, and to the bottom of the other end panel to give the table the strength and avoid the warping of the top. From that point an additional sheet of ¾" multi-ply hardwood is attached to the inside and outside of the end panels and the top, and those items are covered with the laminate of your choice. The underside of the table is a laminated removal panel that allows access to the inner skeleton to access electrical if required.

THICKNESS OF TOP AND END PANELS:

A standard Encore table has a 3" thick top and end panels, if adding electrical into the top, appropriate grommets will be cut into the tops for the electrical. If electrical is specified to go into the table, then the overall thickness of the top and end panels grow to 4 1/2" to allow space for the electrical unit.

SHIPPING:

Please note that the Encore table SHIPS COMPLETELY ASSEMBLED, so please ensure that the table will fit through doorways and into freight elevators prior to ordering.

**ENCORE (ALL WOOD CONSTRUCTION)
WORK TABLES - SLAB ENDS ****

NOTE: Price includes crating cost for shipping



Edge Choice: Self	Laminate Upgrades	
	Laminate Upgrade I	Laminate Upgrade II
 P-10 (self)	ADD	ADD
	RECTANGLE (REC) - SEATED HEIGHT	
ENCORE 24x60x30	\$3,577	\$268 \$715
ENCORE 24x72x30	\$3,800	\$285 \$760
ENCORE 24x84x30	\$4,078	\$306 \$816
ENCORE 24x96x30	\$4,301	\$323 \$860
ENCORE 24x120x30 (3 Legs / 2 Piece)	\$6,438	\$483 \$1,288
ENCORE 24x144x30 (3 Legs / 2 Piece)	\$6,840	\$513 \$1,368
ENCORE 30x60x30	\$3,889	\$292 \$778
ENCORE 30x72x30	\$4,133	\$310 \$827
ENCORE 30x84x30	\$4,565	\$342 \$913
ENCORE 30x96x30	\$4,843	\$363 \$969
ENCORE 30x120x30 (3 Legs / 2 Piece)	\$7,001	\$525 \$1,400
ENCORE 30x144x30 (3 Legs / 2 Piece)	\$7,440	\$558 \$1,488
ENCORE 36x60x30	\$4,450	\$334 \$890
ENCORE 36x72x30	\$4,790	\$359 \$958
ENCORE 36x84x30	\$5,043	\$378 \$1,009
ENCORE 36x96x30	\$5,306	\$398 \$1,061
ENCORE 36x120x30 (3 Legs / 2 Piece)	\$8,010	\$601 \$1,602
ENCORE 36x144x30 (3 Legs / 2 Piece)	\$8,622	\$647 \$1,724
ENCORE 42x60x30	\$4,831	\$362 \$966
ENCORE 42x72x30	\$5,180	\$389 \$1,036
ENCORE 42x84x30	\$5,260	\$394 \$1,052
ENCORE 42x96x30	\$5,619	\$421 \$1,124
ENCORE 42x120x30 (3 Legs / 2 Piece)	\$8,695	\$652 \$1,739
ENCORE 42x144x30 (3 Legs / 2 Piece)	\$9,324	\$699 \$1,865
ENCORE 48x60x30	\$5,506	\$413 \$1,101
ENCORE 48x72x30	\$5,882	\$441 \$1,176
ENCORE 48x84x30	\$5,760	\$432 \$1,152
ENCORE 48x96x30	\$6,248	\$469 \$1,250
ENCORE 48x120x30 (3 Legs / 2 Piece)	\$9,911	\$743 \$1,982
ENCORE 48x144x30 (3 Legs / 2 Piece)	\$10,587	\$794 \$2,117
RECTANGLE (REC) - STANDING HEIGHT		
ENCORE 24x60x42	\$3,705	\$278 \$741
ENCORE 24x72x42	\$3,929	\$295 \$786
ENCORE 24x84x42	\$4,206	\$315 \$841
ENCORE 24x96x42	\$4,430	\$332 \$886
ENCORE 24x120x42 (3 Legs / 2 Piece)	\$6,669	\$500 \$1,334
ENCORE 24x144x42 (3 Legs / 2 Piece)	\$7,072	\$530 \$1,414
ENCORE 30x60x42	\$4,048	\$304 \$810
ENCORE 30x72x42	\$4,292	\$322 \$858
ENCORE 30x84x42	\$4,791	\$359 \$958
ENCORE 30x96x42	\$5,114	\$384 \$1,023

**ENCORE (ALL WOOD CONSTRUCTION)
WORK TABLES - SLAB ENDS ****

NOTE: Price includes crating cost for shipping



Edge Choice: Self	Laminate Upgrades	
	Laminate Upgrade I	Laminate Upgrade II
 P-10 (self)		
	ADD	ADD
ENCORE 30x120x42 (3 Legs / 2 Piece)	\$7,286	\$546 \$1,457
ENCORE 30x144x42 (3 Legs / 2 Piece)	\$7,725	\$579 \$1,545
ENCORE 36x60x42	\$4,851	\$364 \$970
ENCORE 36x72x42	\$5,123	\$384 \$1,025
ENCORE 36x84x42	\$5,376	\$403 \$1,075
ENCORE 36x96x42	\$5,639	\$423 \$1,128
ENCORE 36x120x42 (3 Legs / 2 Piece)	\$8,732	\$655 \$1,746
ENCORE 36x144x42 (3 Legs / 2 Piece)	\$9,222	\$692 \$1,844
ENCORE 42x60x42	\$5,049	\$379 \$1,010
ENCORE 42x72x42	\$5,408	\$406 \$1,082
ENCORE 42x84x42	\$5,613	\$421 \$1,123
ENCORE 42x96x42	\$5,887	\$442 \$1,177
ENCORE 42x120x42 (3 Legs / 2 Piece)	\$9,088	\$682 \$1,818
ENCORE 42x144x42 (3 Legs / 2 Piece)	\$9,734	\$730 \$1,947
ENCORE 48x60x42	\$5,517	\$414 \$1,103
ENCORE 48x72x42	\$5,993	\$449 \$1,199
ENCORE 48x84x42	\$6,154	\$462 \$1,231
ENCORE 48x96x42	\$6,453	\$484 \$1,291
ENCORE 48x120x42 (3 Legs / 2 Piece)	\$9,931	\$745 \$1,986
ENCORE 48x144x42 (3 Legs / 2 Piece)	\$10,788	\$809 \$2,158

**** NOTE 1: If electrical is added, the thickness of the Encore table increases from 3" to 4-1/2"**

**** NOTE 2: Encore Tables Are All One Piece Except if Noted - Please Confirm Dimensions Will Fit Through Door Openings Before Ordering**

EXCALIBUR



EXCALIBUR

Excalibur tables were developed to offer you quality and styling. Stationary pedestals made of Flat Solid Steel allow the ultimate in a base foundation with unparalleled durability.

Table Pedestal Specifications

Finishes: Available in 40+ standard powder coat finishes. Chrome plated finishes are offered at an additional charge. Our unique mechanical construction enables a flawless seam when mixing column finishes with any base finish. Custom finishes available. Please contact Customer Service for quotation.

Glides and Casters: All tables are equipped with 1" diameter stainless steel, rubber cushioned glides with 1/2" long stem, fully threaded into solid steel base. Optional styles of glides and casters available at an additional charge.

Stationary Table Pedestals: Base of pedestal constructed of cold finished flat solid steel 3/4" x 2-1/4". Fully MIG welded for maximum support. Smaller pedestals equipped with powder coated 10" locking cast spider; larger pedestals equipped with 15" cast spider, machined for column recess to insure levelness. 2" diameter (14 gauge) and 3" diameter (16 gauge) columns constructed from welded, flash controlled tubing. Factory assembled with 1/2"-13 threaded steel rod and flange nut at 60 ft/lb torque. Standard with square ends. Beveled ends are available at an additional charge.

Excalibur Table Options

There are several options available on Excalibur including:

- Nesting
- Flip Top
- Center Mount Electrical Column
- Adjustable Height
- Special Height

EXCALIBUR

EXCALIBUR BASE SPECIFICATIONS

Single Column End Base

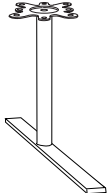

<u>Smart Code</u>	<u>Base Size</u>	<u>Column Diameter</u>	<u>Top Capacity</u>
ES1-16EB	16"	2"	18"x96"
ES1-20EB	20"	2"	24"x96"
ES1-26EB	26"	2"	30"x96"

Double Column End Base

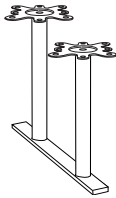

<u>Smart Code</u>	<u>Base Size</u>	<u>Column Diameter</u>	<u>Top Capacity</u>
ES2-30EB	30"	2"	36" & 42"x96"
ES2-36EB	36"	2"	48"x96"

Cross Base

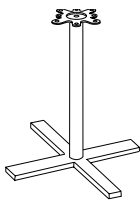

<u>Smart Code</u>	<u>Base Size</u>	<u>Column Diameter</u>	<u>Top Capacity</u>
ESX-20	20"	3"	24" SQ & RND
ESX-26	26"	3"	30" SQ & RND
ESX-30	30"	3"	36" SQ & 42" RND
ESX-36	36"	3"	48" SQ & 54" RND



EXCALIBUR TABLES - (LAMINATE - PVC EDGE)

	Edge Choice: PVC & T-Mold				Laminate Upgrades		Light Weight	OPTIONS								
	T-15 P-10 (self) L-15	L-21 P-12	P-14	PK-2 PK-4 L-23	Laminate Upgrade I	Laminate Upgrade II	Light Weight (PVC only - 1" top)	NESTING	FLIP-TOP	POWDERCOAT UPGRADE	CHROME	DELUXE CASTERS (BLK)	EQUALIZER GLIDES	CENTER MOUNT ELEC.	ADJ. HEIGHT PIN	SPECIAL HEIGHT
				ADD	ADD	ADD	ADD	ADD	ADD	ADD	ADD	ADD	ADD	ADD	ADD	ADD
SQUARE (SQR)																
ESX 24x24	\$934	\$981	\$1,027	\$70	\$187	\$163	N/A	\$112	\$134	\$271	\$163	\$61	\$338	N/A	\$80	
ESX 30x30	\$1,065	\$1,118	\$1,172	\$80	\$213	\$186	N/A	\$112	\$134	\$271	\$163	\$61	\$338	N/A	\$80	
ESX 36x36	\$1,261	\$1,324	\$1,388	\$95	\$252	\$221	N/A	\$112	\$134	\$271	\$163	\$61	\$338	N/A	\$80	
ESX 42x42	\$1,467	\$1,540	\$1,613	\$110	\$293	\$257	N/A	\$112	\$134	\$271	\$163	\$61	\$338	N/A	\$80	
ESX-4 48x48	\$1,907	\$2,002	\$2,097	\$143	\$381	\$334	N/A	N/A	\$134	\$271	\$163	\$61	\$338	N/A	\$80	
ROUND (RND)																
ESX 24	\$963	\$1,011	\$1,060	\$72	\$193	\$169	N/A	\$112	\$134	\$271	\$163	\$61	\$338	N/A	\$80	
ESX 30	\$1,091	\$1,146	\$1,200	\$82	\$218	\$191	N/A	\$112	\$134	\$271	\$163	\$61	\$338	N/A	\$80	
ESX 36	\$1,285	\$1,350	\$1,414	\$96	\$257	\$225	N/A	\$112	\$134	\$271	\$163	\$61	\$338	N/A	\$80	
ESX 42	\$1,389	\$1,458	\$1,528	\$104	\$278	\$243	N/A	\$112	\$134	\$271	\$163	\$61	\$338	N/A	\$80	
ESX 48	\$1,604	\$1,685	\$1,765	\$120	\$321	\$281	N/A	\$112	\$134	\$271	\$163	\$61	\$338	N/A	\$80	
ESX-4 60	\$2,086	\$2,190	\$2,294	\$156	\$417	\$365	N/A	N/A	\$134	\$271	\$163	\$61	N/A	N/A	\$80	
ESX-4 72	\$2,399	\$2,519	\$2,639	\$180	\$480	\$420	N/A	N/A	\$134	\$271	\$163	\$61	N/A	N/A	\$80	
RECTANGLE (REC)																
ES1 18x48	\$1,189	\$1,249	\$1,308	\$89	\$238	\$208	\$389	N/A	\$134	\$339	\$163	\$61	N/A	N/A	\$133	
ES1 18x60	\$1,247	\$1,309	\$1,372	\$94	\$249	\$218	\$389	N/A	\$134	\$339	\$163	\$61	N/A	N/A	\$133	
ES1 18x72	\$1,305	\$1,370	\$1,435	\$98	\$261	\$228	\$389	N/A	\$134	\$339	\$163	\$61	N/A	N/A	\$133	
ES1 18x84	\$1,363	\$1,431	\$1,499	\$102	\$273	\$239	\$389	N/A	\$134	\$339	\$163	\$61	N/A	N/A	\$133	
ES1 18x96	\$1,421	\$1,492	\$1,563	\$107	\$284	\$249	\$389	N/A	\$134	\$339	\$163	\$61	N/A	N/A	\$133	
ES1 24x48	\$1,300	\$1,365	\$1,430	\$98	\$260	\$228	\$389	N/A	\$134	\$339	\$163	\$61	N/A	\$711	\$133	
ESX 24x48 (ESX2036-2)	\$1,549	\$1,626	\$1,704	\$116	\$310	\$271	N/A	N/A	\$268	\$677	N/A	\$122	N/A	N/A	\$265	
ES1 24x60	\$1,372	\$1,441	\$1,509	\$103	\$274	\$240	\$389	N/A	\$134	\$339	\$163	\$61	N/A	\$711	\$133	
ES1 24x72	\$1,444	\$1,516	\$1,589	\$108	\$289	\$253	\$389	N/A	\$134	\$339	\$163	\$61	N/A	\$711	\$133	
ES1 24x84	\$1,516	\$1,592	\$1,668	\$114	\$303	\$265	\$389	N/A	\$134	\$339	\$163	\$61	N/A	N/A	\$133	
ES1 24x96	\$1,588	\$1,667	\$1,747	\$119	\$318	\$278	\$389	N/A	\$134	\$339	\$163	\$61	N/A	N/A	\$133	
ES1 30x48	\$1,435	\$1,507	\$1,579	\$108	\$287	\$251	\$389	N/A	\$134	\$339	\$163	\$61	N/A	\$711	\$133	
ESX 30x48 (ESX2636-2)	\$1,598	\$1,678	\$1,758	\$120	\$320	\$280	N/A	N/A	\$268	\$677	N/A	\$122	N/A	N/A	\$265	
ES1 30x60	\$1,521	\$1,597	\$1,673	\$114	\$304	\$266	\$389	N/A	\$134	\$339	\$163	\$61	N/A	\$711	\$133	
ES1 30x72	\$1,530	\$1,607	\$1,683	\$115	\$306	\$268	\$389	N/A	\$134	\$339	\$163	\$61	N/A	\$711	\$133	
ES1 30x84	\$1,693	\$1,778	\$1,862	\$127	\$339	\$296	\$389	N/A	\$134	\$339	\$163	\$61	N/A	N/A	\$133	
ES1 30x96	\$1,779	\$1,868	\$1,957	\$133	\$356	\$311	\$389	N/A	\$134	\$339	\$163	\$61	N/A	N/A	\$133	
ES2 36x48	\$1,707	\$1,792	\$1,878	\$128	\$341	\$299	N/A	N/A	\$134	\$542	\$163	\$61	N/A	N/A	\$228	
ES2 36x60	\$1,807	\$1,897	\$1,988	\$136	\$361	\$316	N/A	N/A	\$134	\$542	\$163	\$61	N/A	N/A	\$228	
ES2 36x72	\$1,907	\$2,002	\$2,097	\$143	\$381	\$334	N/A	N/A	\$134	\$542	\$163	\$61	N/A	N/A	\$228	
ES2 36x84	\$2,006	\$2,107	\$2,207	\$150	\$401	\$351	N/A	N/A	\$134	\$542	\$163	\$61	N/A	N/A	\$228	
ES2 36x96	\$2,106	\$2,212	\$2,317	\$158	\$421	\$369	N/A	N/A	\$134	\$542	\$163	\$61	N/A	N/A	\$228	
ES2 42x48	\$1,771	\$1,859	\$1,948	\$133	\$354	\$310	N/A	N/A	\$134	\$542	\$163	\$61	N/A	N/A	\$228	
ES2 42x60	\$1,885	\$1,979	\$2,073	\$141	\$377	\$330	N/A	N/A	\$134	\$542	\$163	\$61	N/A	N/A	\$228	
ES2 42x72	\$1,998	\$2,098	\$2,198	\$150	\$400	\$350	N/A	N/A	\$134	\$542	\$163	\$61	N/A	N/A	\$228	









EXCALIBUR TABLES - (LAMINATE - PVC EDGE)

		Edge Choice: PVC & T-Mold				Laminate Upgrades		Light Weight	OPTIONS								
		T-15	L-21	P-14	PK-2	Laminate Upgrade I	Laminate Upgrade II	Light Weight (PVC only - 1" top)	NESTING	FLIP-TOP	POWDERCOAT UPGRADE	CHROME	DELUXE CASTERS (BLK)	EQUALIZER GLIDES	CENTER MOUNT ELEC.	ADJ. HEIGHT PIN	SPECIAL HEIGHT
		P-10 (self)	P-12		PK-4	ADD	ADD	ADD	ADD	ADD	ADD	ADD	ADD	ADD	ADD	ADD	ADD
		L-15			L-23												
ES2	42x84	\$2,112	\$2,218	\$2,323	\$158	\$422	\$370	N/A	N/A	\$134	\$542	\$163	\$61	N/A	N/A	\$228	
ES2	42x96	\$2,226	\$2,337	\$2,449	\$167	\$445	\$390	N/A	N/A	\$134	\$542	\$163	\$61	N/A	N/A	\$228	
ES2	48x72	\$2,271	\$2,384	\$2,498	\$170	\$454	\$397	N/A	N/A	\$134	\$542	\$163	\$61	N/A	N/A	\$228	
ES2	48x84	\$2,399	\$2,519	\$2,639	\$180	\$480	\$420	N/A	N/A	\$134	\$542	\$163	\$61	N/A	N/A	\$228	
ES2	48x96	\$2,526	\$2,653	\$2,779	\$189	\$505	\$442	N/A	N/A	\$134	\$542	\$163	\$61	N/A	N/A	\$228	



EXCALIBUR TABLES - (LAMINATE - WOOD EDGE)

		Edge Choice: Wood (Red Oak & Maple)			Wood Upgrade	OPTIONS								
					Upgrade: Walnut / Mahogany / Cherry	NESTING	FLIP-TOP	POWDERCOAT UPGRADE	CHROME	DELUXE CASTERS (BLK)	EQUALIZER GLIDES	CENTER MOUNT ELEC. COLUMN	ADJ. HEIGHT PIN	SPECIAL HEIGHT
														
SQUARE (SQR)														
ESX	24x24	\$1,401	\$1,634	\$1,868	15%	N/A	\$112	\$134	\$271	\$163	\$61	\$338	N/A	\$80
ESX	30x30	\$1,598	\$1,864	\$2,130	15%	N/A	\$112	\$134	\$271	\$163	\$61	\$338	N/A	\$80
ESX	36x36	\$1,892	\$2,207	\$2,523	15%	N/A	\$112	\$134	\$271	\$163	\$61	\$338	N/A	\$80
ESX	42x42	\$2,750	\$3,300	\$3,667	15%	N/A	\$112	\$134	\$271	\$163	\$61	\$338	N/A	\$80
ESX-4	48x48	\$3,575	\$4,290	\$4,767	15%	N/A	N/A	\$134	\$271	\$163	\$61	\$338	N/A	\$80
ROUND (RND)														
ESX	24	\$1,445	\$1,686	\$1,926	15%	N/A	\$112	\$134	\$271	\$163	\$61	\$338	N/A	\$80
ESX	30	\$1,637	\$1,910	\$2,182	15%	N/A	\$112	\$134	\$271	\$163	\$61	\$338	N/A	\$80
ESX	36	\$1,928	\$2,249	\$2,571	15%	N/A	\$112	\$134	\$271	\$163	\$61	\$338	N/A	\$80
ESX	42	\$2,604	\$3,125	\$3,472	15%	N/A	\$112	\$134	\$271	\$163	\$61	\$338	N/A	\$80
ESX	48	\$3,008	\$3,610	\$4,011	15%	N/A	\$112	\$134	\$271	\$163	\$61	\$338	N/A	\$80
ESX-4	60	\$3,911	\$4,693	\$5,215	15%	N/A	N/A	\$134	\$271	\$163	\$61	N/A	N/A	\$80
ESX-4	72	\$4,693	\$5,632	\$6,257	15%	N/A	N/A	\$134	\$271	\$163	\$61	N/A	N/A	\$80
RECTANGLE (REC)														
ES1	18x48	\$1,784	\$2,081	\$2,378	15%	\$389	N/A	\$134	\$339	\$163	\$61	N/A	N/A	\$133
ES1	18x60	\$1,871	\$2,182	\$2,494	15%	\$389	N/A	\$134	\$339	\$163	\$61	N/A	N/A	\$133
ES1	18x72	\$1,957	\$2,284	\$2,610	15%	\$389	N/A	\$134	\$339	\$163	\$61	N/A	N/A	\$133
ES1	18x84	\$2,131	\$2,487	\$2,842	15%	\$389	N/A	\$134	\$339	\$163	\$61	N/A	N/A	\$133
ES1	18x96	\$2,131	\$2,487	\$2,842	15%	\$389	N/A	\$134	\$339	\$163	\$61	N/A	N/A	\$133
ES1	24x48	\$1,950	\$2,276	\$2,601	15%	\$389	N/A	\$134	\$339	\$163	\$61	N/A	\$711	\$133
ESX	24x48 (ESX2036-2)	\$1,731	\$2,025	\$2,302	15%	N/A	N/A	\$268	\$677	N/A	\$122	N/A	N/A	\$265
ES1	24x60	\$2,058	\$2,401	\$2,744	15%	\$389	N/A	\$134	\$339	\$163	\$61	N/A	\$711	\$133
ES1	24x72	\$2,166	\$2,527	\$2,888	15%	\$389	N/A	\$134	\$339	\$163	\$61	N/A	\$711	\$133
ES1	24x84	\$2,382	\$2,779	\$3,176	15%	\$389	N/A	\$134	\$339	\$163	\$61	N/A	N/A	\$133
ES1	24x96	\$2,382	\$2,779	\$3,176	15%	\$389	N/A	\$134	\$339	\$163	\$61	N/A	N/A	\$133
ES1	30x48	\$2,153	\$2,512	\$2,871	15%	\$389	N/A	\$134	\$339	\$163	\$61	N/A	\$711	\$133
ESX	30x48 (ESX2636-2)	\$1,795	\$2,100	\$2,387	15%	N/A	N/A	\$268	\$677	N/A	\$122	N/A	N/A	\$265
ES1	30x60	\$2,282	\$2,662	\$3,042	15%	\$389	N/A	\$134	\$339	\$163	\$61	N/A	\$711	\$133
ES1	30x72	\$2,296	\$2,678	\$3,061	15%	\$389	N/A	\$134	\$339	\$163	\$61	N/A	\$711	\$133
ES1	30x84	\$2,668	\$3,113	\$3,558	15%	\$389	N/A	\$134	\$339	\$163	\$61	N/A	N/A	\$133
ES1	30x96	\$2,668	\$3,113	\$3,558	15%	\$389	N/A	\$134	\$339	\$163	\$61	N/A	N/A	\$133
ES2	36x48	\$2,560	\$2,987	\$3,414	15%	N/A	N/A	\$134	\$542	\$163	\$61	N/A	N/A	\$228
ES2	36x60	\$2,710	\$3,162	\$3,614	15%	N/A	N/A	\$134	\$542	\$163	\$61	N/A	N/A	\$228
ES2	36x72	\$2,860	\$3,337	\$3,813	15%	N/A	N/A	\$134	\$542	\$163	\$61	N/A	N/A	\$228
ES2	36x84	\$3,159	\$3,686	\$4,213	15%	N/A	N/A	\$134	\$542	\$163	\$61	N/A	N/A	\$228
ES2	36x96	\$3,159	\$3,686	\$4,213	15%	N/A	N/A	\$134	\$542	\$163	\$61	N/A	N/A	\$228
ES2	42x48	\$3,320	\$3,984	\$4,427	15%	N/A	N/A	\$134	\$542	\$163	\$61	N/A	N/A	\$228
ES2	42x60	\$3,534	\$4,240	\$4,712	15%	N/A	N/A	\$134	\$542	\$163	\$61	N/A	N/A	\$228
ES2	42x72	\$3,710	\$4,453	\$4,947	15%	N/A	N/A	\$134	\$542	\$163	\$61	N/A	N/A	\$228









EXCALIBUR TABLES - (LAMINATE - WOOD EDGE)

		Edge Choice: Wood (Red Oak & Maple)			Wood Upgrade	OPTIONS									
		W-12	W-23	W-19	Upgrade: Walnut / Mahogany / Cherry	NESTING	FLIP-TOP	POWDERCOAT UPGRADE	CHROME	DELUXE CASTERS (BLK)	EQUALIZER GLIDES	CENTER MOUNT ELEC. COLUMN	ADJ. HEIGHT PIN	SPECIAL HEIGHT	
						ADD	ADD	ADD	ADD	ADD	ADD	ADD	ADD	ADD	
		W-16	W-17	W-32											
ES2	42x84	\$3,896	\$4,675	\$5,195	15%	N/A	N/A	\$134	\$542	\$163	\$61	N/A	N/A	\$228	
ES2	42x96	\$4,091	\$4,909	\$5,454	15%	N/A	N/A	\$134	\$542	\$163	\$61	N/A	N/A	\$228	
ES2	48x72	\$4,258	\$5,110	\$5,677	15%	N/A	N/A	\$134	\$542	\$163	\$61	N/A	N/A	\$228	
ES2	48x84	\$4,737	\$5,684	\$6,316	15%	N/A	N/A	\$134	\$542	\$163	\$61	N/A	N/A	\$228	
ES2	48x96	\$4,737	\$5,684	\$6,316	15%	N/A	N/A	\$134	\$542	\$163	\$61	N/A	N/A	\$228	



EXCALIBUR TABLES - (VENEER)

		Edge Choice: Wood (Red Oak & Maple)			Wood Upgrade	OPTIONS								
					Upgrade: Walnut / Mahogany / Cherry	NESTING	FLIP-TOP	POWDERCOAT UPGRADE	CHROME	DELUXE CASTERS (BLK)	EQUALIZER GLIDES	CENTER MOUNT ELEC. COLUMN	ADJ. HEIGHT PIN	SPECIAL HEIGHT
														
SQUARE (SQR)														
ESX	24x24	\$1,616	\$1,778	\$1,859	15%	N/A	\$112	\$134	\$271	\$163	\$61	\$338	N/A	\$80
ESX	30x30	\$2,093	\$2,302	\$2,407	15%	N/A	\$112	\$134	\$271	\$163	\$61	\$338	N/A	\$80
ESX	36x36	\$2,649	\$2,914	\$3,046	15%	N/A	\$112	\$134	\$271	\$163	\$61	\$338	N/A	\$80
ESX	42x42	\$3,366	\$3,703	\$3,871	15%	N/A	\$112	\$134	\$271	\$163	\$61	\$338	N/A	\$80
ESX-4	48x48	\$4,376	\$4,814	\$5,032	15%	N/A	N/A	\$134	\$271	\$163	\$61	\$338	N/A	\$80
ROUND (RND)														
ESX	24	\$1,750	\$1,924	\$2,012	15%	N/A	\$112	\$134	\$271	\$163	\$61	\$338	N/A	\$80
ESX	30	\$2,311	\$2,543	\$2,658	15%	N/A	\$112	\$134	\$271	\$163	\$61	\$338	N/A	\$80
ESX	36	\$2,743	\$3,018	\$3,155	15%	N/A	\$112	\$134	\$271	\$163	\$61	\$338	N/A	\$80
ESX	42	\$3,401	\$3,742	\$3,912	15%	N/A	\$112	\$134	\$271	\$163	\$61	\$338	N/A	\$80
ESX	48	\$4,274	\$4,702	\$4,915	15%	N/A	\$112	\$134	\$271	\$163	\$61	\$338	N/A	\$80
ESX-4	60	\$5,557	\$6,112	\$6,390	15%	N/A	N/A	\$134	\$271	\$163	\$61	N/A	N/A	\$80
ESX-4	72	\$6,668	\$7,335	\$7,668	15%	N/A	N/A	\$134	\$271	\$163	\$61	N/A	N/A	\$80
RECTANGLE (REC)														
ES1	18x48	\$1,940	\$2,134	\$2,231	15%	\$389	N/A	\$134	\$339	\$163	\$61	N/A	N/A	\$133
ES1	18x60	\$2,218	\$2,440	\$2,550	15%	\$389	N/A	\$134	\$339	\$163	\$61	N/A	N/A	\$133
ES1	18x72	\$2,503	\$2,753	\$2,878	15%	\$389	N/A	\$134	\$339	\$163	\$61	N/A	N/A	\$133
ES1	18x84	\$3,073	\$3,381	\$3,534	15%	\$389	N/A	\$134	\$339	\$163	\$61	N/A	N/A	\$133
ES1	18x96	\$3,073	\$3,381	\$3,534	15%	\$389	N/A	\$134	\$339	\$163	\$61	N/A	N/A	\$133
ES1	24x48	\$2,583	\$2,842	\$2,971	15%	\$389	N/A	\$134	\$339	\$163	\$61	N/A	\$711	\$133
ESX	24x48 (ESX2036-2)	\$2,076	\$2,284	\$2,387	15%	N/A	N/A	N/A	\$677	N/A	\$122	N/A	N/A	\$265
ES1	24x60	\$2,265	\$2,492	\$2,605	15%	\$389	N/A	\$134	\$339	\$163	\$61	N/A	\$711	\$133
ES1	24x72	\$2,550	\$2,805	\$2,933	15%	\$389	N/A	\$134	\$339	\$163	\$61	N/A	\$711	\$133
ES1	24x84	\$3,121	\$3,433	\$3,589	15%	\$389	N/A	\$134	\$339	\$163	\$61	N/A	N/A	\$133
ES1	24x96	\$3,121	\$3,433	\$3,589	15%	\$389	N/A	\$134	\$339	\$163	\$61	N/A	N/A	\$133
ES1	30x48	\$2,314	\$2,546	\$2,661	15%	\$389	N/A	\$134	\$339	\$163	\$61	N/A	\$711	\$133
ESX	30x48 (ESX2636-2)	\$2,273	\$2,500	\$2,614	15%	N/A	N/A	N/A	\$677	N/A	\$122	N/A	N/A	\$265
ES1	30x60	\$2,665	\$2,932	\$3,065	15%	\$389	N/A	\$134	\$339	\$163	\$61	N/A	\$711	\$133
ES1	30x72	\$3,016	\$3,318	\$3,469	15%	\$389	N/A	\$134	\$339	\$163	\$61	N/A	\$711	\$133
ES1	30x84	\$3,718	\$4,090	\$4,276	15%	\$389	N/A	\$134	\$339	\$163	\$61	N/A	N/A	\$133
ES1	30x96	\$3,718	\$4,090	\$4,276	15%	\$389	N/A	\$134	\$339	\$163	\$61	N/A	N/A	\$133
ES2	36x48	\$2,807	\$3,088	\$3,228	15%	N/A	N/A	\$134	\$542	\$163	\$61	N/A	N/A	\$228
ES2	36x60	\$3,224	\$3,547	\$3,708	15%	N/A	N/A	\$134	\$542	\$163	\$61	N/A	N/A	\$228
ES2	36x72	\$3,641	\$4,005	\$4,187	15%	N/A	N/A	\$134	\$542	\$163	\$61	N/A	N/A	\$228
ES2	36x84	\$4,482	\$4,930	\$5,154	15%	N/A	N/A	\$134	\$542	\$163	\$61	N/A	N/A	\$228
ES2	36x96	\$4,482	\$4,930	\$5,154	15%	N/A	N/A	\$134	\$542	\$163	\$61	N/A	N/A	\$228
ES2	42x48	\$4,011	\$4,412	\$4,612	15%	N/A	N/A	\$134	\$542	\$163	\$61	N/A	N/A	\$228
ES2	42x60	\$4,648	\$5,113	\$5,345	15%	N/A	N/A	\$134	\$542	\$163	\$61	N/A	N/A	\$228
ES2	42x72	\$4,880	\$5,368	\$5,612	15%	N/A	N/A	\$134	\$542	\$163	\$61	N/A	N/A	\$228



EXCALIBUR TABLES - (VENEER)

		Edge Choice: Wood (Red Oak & Maple)			Wood Upgrade	OPTIONS									
		V-12	V-23	V-19	Upgrade: Walnut / Mahogany / Cherry	NESTING	FLIP-TOP	POWDERCOAT UPGRADE	CHROME	DELUXE CASTERS (BLIK)	EQUALIZER GLIDES	CENTER MOUNT ELEC. COLUMN	ADJ. HEIGHT PIN	SPECIAL HEIGHT	
			V-18	V-17		ADD	ADD	ADD	ADD	ADD	ADD	ADD	ADD	ADD	
			V-16	V-32											
ES2	42x84	\$5,124	\$5,637	\$5,893	15%	N/A	N/A	\$134	\$542	\$163	\$61	N/A	N/A	\$228	
ES2	42x96	\$5,380	\$5,918	\$6,187	15%	N/A	N/A	\$134	\$542	\$163	\$61	N/A	N/A	\$228	
ES2	48x72	\$4,663	\$5,129	\$5,362	15%	N/A	N/A	\$134	\$542	\$163	\$61	N/A	N/A	\$228	
ES2	48x84	\$5,782	\$6,360	\$6,649	15%	N/A	N/A	\$134	\$542	\$163	\$61	N/A	N/A	\$228	
ES2	48x96	\$5,782	\$6,360	\$6,649	15%	N/A	N/A	\$134	\$542	\$163	\$61	N/A	N/A	\$228	

EXCALIBUR SQUARED



EXCALIBUR SQUARED

EXCALIBUR SQUARED BASE SPECIFICATIONS

Single Column End Base



<u>Smart Code</u>	<u>Base Size</u>	<u>Column Size</u>	<u>Top Capacity</u>
ESQ1-16EB	16"	2"	18"x96"
ESQ1-20EB	20"	2"	24"x96"
ESQ1-26EB	26"	2"	30"x96"

Double Column End Base

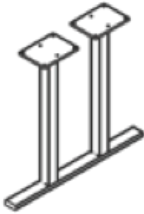

<u>Smart Code</u>	<u>Base Size</u>	<u>Column Size</u>	<u>Top Capacity</u>
ESQ2-30EB	30"	2"	42"x96"
ESQ2-36EB	36"	2"	48"x96"

Cross Base



<u>Smart Code</u>	<u>Base Size</u>	<u>Column Size</u>	<u>Top Capacity</u>
ESQX-20X	20"	2.5"	24" SQ & RND
ESQX-26X	26"	2.5"	30" SQ & RND
ESQX-30X	30"	2.5"	36" SQ & 42" RND
ESQX-36X	36"	2.5"	42" SQ & 48" RND

EXCALIBUR SQUARED TABLES - (LAMINATE - PVC EDGE)



	Edge Choice: PVC & T-Mold				Laminate Upgrades		Light Weight	OPTIONS								
	T-15	L-21	P-14	PK-2	Laminate Upgrade I	Laminate Upgrade II	Light Weight (PVC only - 1" top)	NESTING	FLIP-TOP	POWDERCOAT UPGRADE	CHROME	DELUXE CASTERS (BLK)	EQUALIZER GLIDES	ADJ. HEIGHT PIN	SPECIAL HEIGHT	
	P-10 (self)	P-12		PK-4	ADD	ADD	ADD	ADD	ADD	ADD	ADD	ADD	ADD	ADD	ADD	
	L-15			L-23												
SQUARE (SQR)																
ESQX 24x24	\$1,146	\$1,203	\$1,260	\$86	\$229	\$201	N/A	\$112	\$134	\$406	\$163	\$61	N/A	\$80		
ESQX 30x30	\$1,287	\$1,352	\$1,416	\$97	\$257	\$225	N/A	\$112	\$134	\$406	\$163	\$61	N/A	\$80		
ESQX 36x36	\$1,497	\$1,572	\$1,647	\$112	\$299	\$262	N/A	\$112	\$134	\$406	\$163	\$61	N/A	\$80		
ESQX 42x42	\$1,674	\$1,758	\$1,841	\$126	\$335	\$293	N/A	\$112	\$134	\$406	\$163	\$61	N/A	\$80		
ROUND (RND)																
ESQX 24	\$1,175	\$1,234	\$1,293	\$88	\$235	\$206	N/A	\$112	\$134	\$406	\$163	\$61	N/A	\$80		
ESQX 30	\$1,313	\$1,379	\$1,445	\$99	\$263	\$230	N/A	\$112	\$134	\$406	\$163	\$61	N/A	\$80		
ESQX 36	\$1,521	\$1,597	\$1,673	\$114	\$304	\$266	N/A	\$112	\$134	\$406	\$163	\$61	N/A	\$80		
ESQX 42	\$1,624	\$1,706	\$1,787	\$122	\$325	\$284	N/A	\$112	\$134	\$406	\$163	\$61	N/A	\$80		
ESQX 48	\$1,812	\$1,902	\$1,993	\$136	\$362	\$317	N/A	\$112	\$134	\$406	\$163	\$61	N/A	\$80		
RECTANGLE (REC)																
ESQ1 18x48	\$1,394	\$1,464	\$1,533	\$105	\$279	\$244	\$389	N/A	\$134	\$406	\$163	\$61	N/A	\$133		
ESQ1 18x60	\$1,452	\$1,525	\$1,597	\$109	\$290	\$254	\$389	N/A	\$134	\$406	\$163	\$61	N/A	\$133		
ESQ1 18x72	\$1,510	\$1,585	\$1,661	\$113	\$302	\$264	\$389	N/A	\$134	\$406	\$163	\$61	N/A	\$133		
ESQ1 18x84	\$1,568	\$1,646	\$1,725	\$118	\$314	\$274	\$389	N/A	\$134	\$406	\$163	\$61	N/A	\$133		
ESQ1 18x96	\$1,626	\$1,707	\$1,788	\$122	\$325	\$285	\$389	N/A	\$134	\$406	\$163	\$61	N/A	\$133		
ESQ1 24x48	\$1,506	\$1,581	\$1,656	\$113	\$301	\$263	\$389	N/A	\$134	\$406	\$163	\$61	N/A	\$133		
ESQ1 24x60	\$1,577	\$1,656	\$1,735	\$118	\$315	\$276	\$389	N/A	\$134	\$406	\$163	\$61	N/A	\$133		
ESQ1 24x72	\$1,649	\$1,732	\$1,814	\$124	\$330	\$289	\$389	N/A	\$134	\$406	\$163	\$61	N/A	\$133		
ESQ1 24x84	\$1,721	\$1,807	\$1,893	\$129	\$344	\$301	\$389	N/A	\$134	\$406	\$163	\$61	N/A	\$133		
ESQ1 24x96	\$1,793	\$1,883	\$1,973	\$134	\$359	\$314	\$389	N/A	\$134	\$406	\$163	\$61	N/A	\$133		
ESQ1 30x48	\$1,640	\$1,722	\$1,803	\$123	\$328	\$287	\$389	N/A	\$134	\$406	\$163	\$61	N/A	\$133		
ESQ1 30x60	\$1,725	\$1,812	\$1,898	\$129	\$345	\$302	\$389	N/A	\$134	\$406	\$163	\$61	N/A	\$133		
ESQ1 30x72	\$1,735	\$1,821	\$1,908	\$130	\$347	\$304	\$389	N/A	\$134	\$406	\$163	\$61	N/A	\$133		
ESQ1 30x84	\$1,897	\$1,992	\$2,087	\$142	\$379	\$332	\$389	N/A	\$134	\$406	\$163	\$61	N/A	\$133		
ESQ1 30x96	\$1,983	\$2,082	\$2,181	\$149	\$397	\$347	\$389	N/A	\$134	\$406	\$163	\$61	N/A	\$133		
ESQ2 36x48	\$2,216	\$2,327	\$2,438	\$166	\$443	\$388	N/A	N/A	\$134	\$406	\$163	\$61	N/A	\$228		
ESQ2 36x60	\$2,316	\$2,432	\$2,548	\$174	\$463	\$405	N/A	N/A	\$134	\$406	\$163	\$61	N/A	\$228		
ESQ2 36x72	\$2,416	\$2,537	\$2,657	\$181	\$483	\$423	N/A	N/A	\$134	\$406	\$163	\$61	N/A	\$228		
ESQ2 36x84	\$2,516	\$2,641	\$2,767	\$189	\$503	\$440	N/A	N/A	\$134	\$406	\$163	\$61	N/A	\$228		
ESQ2 36x96	\$2,615	\$2,746	\$2,877	\$196	\$523	\$458	N/A	N/A	\$134	\$406	\$163	\$61	N/A	\$228		
ESQ2 42x48	\$2,280	\$2,394	\$2,508	\$171	\$456	\$399	N/A	N/A	\$134	\$406	\$163	\$61	N/A	\$228		
ESQ2 42x60	\$2,394	\$2,513	\$2,633	\$180	\$479	\$419	N/A	N/A	\$134	\$406	\$163	\$61	N/A	\$228		
ESQ2 42x72	\$2,508	\$2,633	\$2,758	\$188	\$502	\$439	N/A	N/A	\$134	\$406	\$163	\$61	N/A	\$228		
ESQ2 42x84	\$2,621	\$2,752	\$2,883	\$197	\$524	\$459	N/A	N/A	\$134	\$406	\$163	\$61	N/A	\$228		
ESQ2 42x96	\$2,735	\$2,872	\$3,009	\$205	\$547	\$479	N/A	N/A	\$134	\$406	\$163	\$61	N/A	\$228		
ESQ2 48x72	\$2,669	\$2,803	\$2,936	\$200	\$534	\$467	N/A	N/A	\$134	\$406	\$163	\$61	N/A	\$228		
ESQ2 48x84	\$2,797	\$2,937	\$3,077	\$210	\$559	\$489	N/A	N/A	\$134	\$406	\$163	\$61	N/A	\$228		
ESQ2 48x96	\$2,925	\$3,071	\$3,217	\$219	\$585	\$512	N/A	N/A	\$134	\$406	\$163	\$61	N/A	\$228		



EXCALIBUR SQUARED TABLES - (LAMINATE - WOOD EDGE)

	Edge Choice: Wood (Red Oak & Maple)			Wood Upgrade	OPTIONS							
	W-12	W-23 W-18 W-16	W-19 W-17 W-32	Upgrade: Walnut / Mahogany / Cherry	NESTING	FLIP-TOP	POWDERCOAT UPGRADE	CHROME	DELUXE CASTERS (BLK)	EQUALIZER GLIDES	ADJ. HEIGHT PIN	SPECIAL HEIGHT
				ADD	ADD	ADD	ADD	ADD	ADD	ADD	ADD	ADD
SQUARE (SQR)												
ESQX 24x24	\$1,719	\$2,005	\$2,292	15%	N/A	\$112	\$134	\$406	\$163	\$61	N/A	\$80
ESQX 30x30	\$1,931	\$2,253	\$2,575	15%	N/A	\$112	\$134	\$406	\$163	\$61	N/A	\$80
ESQX 36x36	\$2,246	\$2,620	\$2,994	15%	N/A	\$112	\$134	\$406	\$163	\$61	N/A	\$80
ESQX 42x42	\$3,139	\$3,766	\$4,185	15%	N/A	\$112	\$134	\$406	\$163	\$61	N/A	\$80
ROUND (RND)												
ESQX 24	\$1,763	\$2,056	\$2,350	15%	N/A	\$112	\$134	\$406	\$163	\$61	N/A	\$80
ESQX 30	\$1,970	\$2,298	\$2,627	15%	N/A	\$112	\$134	\$406	\$163	\$61	N/A	\$80
ESQX 36	\$2,281	\$2,662	\$3,042	15%	N/A	\$112	\$134	\$406	\$163	\$61	N/A	\$80
ESQX 42	\$3,046	\$3,655	\$4,061	15%	N/A	\$112	\$134	\$406	\$163	\$61	N/A	\$80
ESQX 48	\$3,397	\$4,076	\$4,529	15%	N/A	\$112	\$134	\$406	\$163	\$61	N/A	\$80
RECTANGLE (REC)												
ESQ1 18x48	\$2,091	\$2,440	\$2,788	15%	\$389	N/A	\$134	\$406	\$163	\$61	N/A	\$133
ESQ1 18x60	\$2,178	\$2,541	\$2,904	15%	\$389	N/A	\$134	\$406	\$163	\$61	N/A	\$133
ESQ1 18x72	\$2,265	\$2,642	\$3,020	15%	\$389	N/A	\$134	\$406	\$163	\$61	N/A	\$133
ESQ1 18x84	\$2,439	\$2,845	\$3,252	15%	\$389	N/A	\$134	\$406	\$163	\$61	N/A	\$133
ESQ1 18x96	\$2,439	\$2,845	\$3,252	15%	\$389	N/A	\$134	\$406	\$163	\$61	N/A	\$133
ESQ1 24x48	\$2,258	\$2,635	\$3,011	15%	\$389	N/A	\$134	\$406	\$163	\$61	N/A	\$133
ESQ1 24x60	\$2,366	\$2,761	\$3,155	15%	\$389	N/A	\$134	\$406	\$163	\$61	N/A	\$133
ESQ1 24x72	\$2,474	\$2,886	\$3,299	15%	\$389	N/A	\$134	\$406	\$163	\$61	N/A	\$133
ESQ1 24x84	\$2,690	\$3,138	\$3,586	15%	\$389	N/A	\$134	\$406	\$163	\$61	N/A	\$133
ESQ1 24x96	\$2,690	\$3,138	\$3,586	15%	\$389	N/A	\$134	\$406	\$163	\$61	N/A	\$133
ESQ1 30x48	\$2,459	\$2,869	\$3,279	15%	\$389	N/A	\$134	\$406	\$163	\$61	N/A	\$133
ESQ1 30x60	\$2,588	\$3,019	\$3,451	15%	\$389	N/A	\$134	\$406	\$163	\$61	N/A	\$133
ESQ1 30x72	\$2,602	\$3,036	\$3,469	15%	\$389	N/A	\$134	\$406	\$163	\$61	N/A	\$133
ESQ1 30x84	\$2,975	\$3,470	\$3,966	15%	\$389	N/A	\$134	\$406	\$163	\$61	N/A	\$133
ESQ1 30x96	\$2,975	\$3,470	\$3,966	15%	\$389	N/A	\$134	\$406	\$163	\$61	N/A	\$133
ESQ2 36x48	\$3,324	\$3,878	\$4,432	15%	N/A	N/A	\$134	\$406	\$163	\$61	N/A	\$228
ESQ2 36x60	\$3,474	\$4,053	\$4,632	15%	N/A	N/A	\$134	\$406	\$163	\$61	N/A	\$228
ESQ2 36x72	\$3,624	\$4,228	\$4,831	15%	N/A	N/A	\$134	\$406	\$163	\$61	N/A	\$228
ESQ2 36x84	\$3,923	\$4,577	\$5,231	15%	N/A	N/A	\$134	\$406	\$163	\$61	N/A	\$228
ESQ2 36x96	\$3,923	\$4,577	\$5,231	15%	N/A	N/A	\$134	\$406	\$163	\$61	N/A	\$228
ESQ2 42x48	\$4,275	\$5,130	\$5,700	15%	N/A	N/A	\$134	\$406	\$163	\$61	N/A	\$228
ESQ2 42x60	\$4,488	\$5,386	\$5,984	15%	N/A	N/A	\$134	\$406	\$163	\$61	N/A	\$228
ESQ2 42x72	\$4,713	\$5,655	\$6,284	15%	N/A	N/A	\$134	\$406	\$163	\$61	N/A	\$228
ESQ2 42x84	\$4,948	\$5,938	\$6,598	15%	N/A	N/A	\$134	\$406	\$163	\$61	N/A	\$228
ESQ2 42x96	\$5,196	\$6,235	\$6,928	15%	N/A	N/A	\$134	\$406	\$163	\$61	N/A	\$228
ESQ2 48x72	\$5,005	\$6,006	\$6,673	15%	N/A	N/A	\$134	\$406	\$163	\$61	N/A	\$228
ESQ2 48x84	\$5,484	\$6,581	\$7,312	15%	N/A	N/A	\$134	\$406	\$163	\$61	N/A	\$228
ESQ2 48x96	\$5,484	\$6,581	\$7,312	15%	N/A	N/A	\$99	\$406	\$163	\$61	N/A	\$228



EXCALIBUR SQUARED TABLES - (VENEER)

	Edge Choice: Wood (Red Oak & Maple)			Wood Upgrade	OPTIONS							
	V-12	V-23 V-18 V-16	V-19 V-17 V-32	Upgrade: Walnut / Mahogany / Cherry	NESTING	FLIP-TOP	POWDERCOAT UPGRADE	CHROME	DELUXE CASTERS (BLK)	EQUALIZER GLIDES	ADJ. HEIGHT PIN	SPECIAL HEIGHT
				ADD	ADD	ADD	ADD	ADD	ADD	ADD	ADD	ADD
SQUARE (SQR)												
ESQX 24x24	\$1,906	\$2,097	\$2,192	15%	N/A	\$112	\$134	\$406	\$163	\$61	N/A	\$80
ESQX 30x30	\$2,397	\$2,636	\$2,756	15%	N/A	\$112	\$134	\$406	\$163	\$61	N/A	\$80
ESQX 36x36	\$2,955	\$3,250	\$3,398	15%	N/A	\$112	\$134	\$406	\$163	\$61	N/A	\$80
ESQX 42x42	\$3,635	\$3,999	\$4,181	15%	N/A	\$112	\$134	\$406	\$163	\$61	N/A	\$80
ROUND (RND)												
ESQX 24	\$2,040	\$2,243	\$2,345	15%	N/A	\$112	\$134	\$406	\$163	\$61	N/A	\$80
ESQX 30	\$2,615	\$2,877	\$3,008	15%	N/A	\$112	\$134	\$406	\$163	\$61	N/A	\$80
ESQX 36	\$3,278	\$3,606	\$3,770	15%	N/A	\$112	\$134	\$406	\$163	\$61	N/A	\$80
ESQX 42	\$3,991	\$4,390	\$4,590	15%	N/A	\$112	\$134	\$406	\$163	\$61	N/A	\$80
ESQX 48	\$4,900	\$5,390	\$5,635	15%	N/A	\$112	\$134	\$406	\$163	\$61	N/A	\$80
RECTANGLE (REC)												
ESQ1 18x48	\$2,574	\$2,831	\$2,960	15%	\$389	N/A	\$134	\$406	\$163	\$61	N/A	\$133
ESQ1 18x60	\$2,907	\$3,198	\$3,343	15%	\$389	N/A	\$134	\$406	\$163	\$61	N/A	\$133
ESQ1 18x72	\$3,250	\$3,574	\$3,737	15%	\$389	N/A	\$134	\$406	\$163	\$61	N/A	\$133
ESQ1 18x84	\$3,934	\$4,327	\$4,524	15%	\$389	N/A	\$134	\$406	\$163	\$61	N/A	\$133
ESQ1 18x96	\$3,934	\$4,327	\$4,524	15%	\$389	N/A	\$134	\$406	\$163	\$61	N/A	\$133
ESQ1 24x48	\$2,631	\$2,894	\$3,026	15%	\$389	N/A	\$134	\$406	\$163	\$61	N/A	\$133
ESQ1 24x60	\$2,964	\$3,261	\$3,409	15%	\$389	N/A	\$134	\$406	\$163	\$61	N/A	\$133
ESQ1 24x72	\$3,307	\$3,637	\$3,803	15%	\$389	N/A	\$134	\$406	\$163	\$61	N/A	\$133
ESQ1 24x84	\$3,991	\$4,390	\$4,590	15%	\$389	N/A	\$134	\$406	\$163	\$61	N/A	\$133
ESQ1 24x96	\$3,991	\$4,390	\$4,590	15%	\$389	N/A	\$134	\$406	\$163	\$61	N/A	\$133
ESQ1 30x48	\$3,022	\$3,324	\$3,476	15%	\$389	N/A	\$134	\$406	\$163	\$61	N/A	\$133
ESQ1 30x60	\$3,443	\$3,788	\$3,960	15%	\$389	N/A	\$134	\$406	\$163	\$61	N/A	\$133
ESQ1 30x72	\$3,865	\$4,251	\$4,444	15%	\$389	N/A	\$134	\$406	\$163	\$61	N/A	\$133
ESQ1 30x84	\$4,707	\$5,178	\$5,413	15%	\$389	N/A	\$134	\$406	\$163	\$61	N/A	\$133
ESQ1 30x96	\$4,707	\$5,178	\$5,413	15%	\$389	N/A	\$134	\$406	\$163	\$61	N/A	\$133
ESQ2 36x48	\$3,980	\$4,378	\$4,577	15%	N/A	N/A	\$134	\$406	\$163	\$61	N/A	\$228
ESQ2 36x60	\$4,480	\$4,928	\$5,152	15%	N/A	N/A	\$134	\$406	\$163	\$61	N/A	\$228
ESQ2 36x72	\$4,980	\$5,478	\$5,727	15%	N/A	N/A	\$134	\$406	\$163	\$61	N/A	\$228
ESQ2 36x84	\$4,991	\$5,490	\$5,740	15%	N/A	N/A	\$134	\$406	\$163	\$61	N/A	\$228
ESQ2 36x96	\$4,991	\$5,490	\$5,740	15%	N/A	N/A	\$134	\$406	\$163	\$61	N/A	\$228
ESQ2 42x48	\$4,313	\$4,744	\$4,960	15%	N/A	N/A	\$134	\$406	\$163	\$61	N/A	\$228
ESQ2 42x60	\$4,901	\$5,391	\$5,636	15%	N/A	N/A	\$134	\$406	\$163	\$61	N/A	\$228
ESQ2 42x72	\$5,146	\$5,661	\$5,918	15%	N/A	N/A	\$134	\$406	\$163	\$61	N/A	\$228
ESQ2 42x84	\$5,403	\$5,944	\$6,214	15%	N/A	N/A	\$134	\$406	\$163	\$61	N/A	\$228
ESQ2 42x96	\$5,674	\$6,241	\$6,525	15%	N/A	N/A	\$134	\$406	\$163	\$61	N/A	\$228
ESQ2 48x72	\$6,073	\$6,681	\$6,984	15%	N/A	N/A	\$134	\$406	\$163	\$61	N/A	\$228
ESQ2 48x84	\$7,416	\$8,158	\$8,528	15%	N/A	N/A	\$134	\$406	\$163	\$61	N/A	\$228
ESQ2 48x96	\$7,416	\$8,158	\$8,528	15%	N/A	N/A	\$99	\$406	\$163	\$61	N/A	\$228

IQ PLUS



iQ PLUS

Our iQ Plus is developed solely with the goal of aesthetics, quality and value contributing to the finished product. iQ Plus tables can be configured to be one of the most environmentally friendly tables in our industry. This is achieved by using a laminated core top surface paired with pedestals of recycled aluminum.

Pedestal Specifications

Finishes: Over 40+ powder coat finishes are offered. Our unique mechanical construction creates a flawless seam when matching column finishes with any base finish. Plastic inner column cover finished in S10 Ebony.

Glides and Casters: All tables are equipped with 2" diameter glides with brushed stainless steel cover over black plastic foot. The stem is M10 and 15mm long. The glide is suitable for carpet, as well as hard floors. Our high quality twin wheel locking casters are offered as an option.

Pedestal Specifications: The foot is aluminum die casting. Column is extruded aluminum. Stationary pedestals feature an aluminum die cast spider support. The foot, column, spider or flip-top are attached together with (2) 3/8"-18 threaded steel rod and flange nuts at 35 ft/lbs torque.

Folding Mechanism: Our patented spring loaded folding mechanism is fully riveted to a steel mounting plate. Vinyl bumpers are integrated into the mechanism allowing for a non-marring, 3-1/2" stacking height. Equipped with molded release handle and an integral catch holds leg in folded position. Folding legs feature the same column housing as iQ stationary attached to Berco's patented folding mechanism.

iQ Plus Table Options

There are several options available on iQ Plus including:

- Folding
- Flip Top – iQ Plus uses a single-point-release bridge with 2 flip tops instead of a nesting structure (for rectangular tables only)
- Special Height

iQ PLUS BASE SPECIFICATIONS

<u>End Base</u>	<u>Smart Code</u>	<u>Base Size</u>	<u>Column Size</u>	<u>Top Capacity</u>
	IQS-22EB	22"	2"x6.75"	30"x96"

iQ PLUS TABLES - (LAMINATE - PVC EDGE)



Edge Choices: PVC & T-Mold				Laminate Upgrades		Light Weight	OPTIONS			
				Laminate Upgrade I	Laminate Upgrade II	Light Weight (PVC only - 1" top)	FLIP-TOP	POWDERCOAT UPGRADE	DELUXE CASTERS (BLK)	SPECIAL HEIGHT
				ADD	ADD	ADD	ADD	ADD	ADD	ADD
RECTANGLE (REC)										
IQS 24x48	\$1,246	\$1,308	\$1,371	\$93	\$249	\$218	\$315	\$134	\$163	\$133
IQS 24x60	\$1,318	\$1,384	\$1,450	\$99	\$264	\$231	\$315	\$134	\$163	\$133
IQS 24x72	\$1,390	\$1,459	\$1,529	\$104	\$278	\$243	\$315	\$134	\$163	\$133
IQS 24x84	\$1,462	\$1,535	\$1,608	\$110	\$292	\$256	\$315	\$134	\$163	\$133
IQS 24x96	\$1,534	\$1,610	\$1,687	\$115	\$307	\$268	\$315	\$134	\$163	\$133
IQS 30x48	\$1,310	\$1,376	\$1,441	\$98	\$262	\$229	\$315	\$134	\$163	\$133
IQS 30x60	\$1,396	\$1,466	\$1,535	\$105	\$279	\$244	\$315	\$134	\$163	\$133
IQS 30x72	\$1,405	\$1,475	\$1,546	\$105	\$281	\$246	\$315	\$134	\$163	\$133
IQS 30x84	\$1,568	\$1,646	\$1,724	\$118	\$314	\$274	\$315	\$134	\$163	\$133
IQS 30x96	\$1,653	\$1,736	\$1,819	\$124	\$331	\$289	\$315	\$134	\$163	\$133
HALF ROUND (HRD)										
IQS 30x60	\$1,423	\$1,494	\$1,566	\$107	\$285	\$249	N/A	\$134	\$163	\$133
QUARTER ROUND (QRD)										
IQS 30x30	\$1,226	\$1,287	\$1,348	\$92	\$245	\$215	N/A	\$134	\$163	\$133
CRESCENT (CRT)										
IQS 24x24x48	\$1,336	\$1,402	\$1,469	\$100	\$267	\$234	N/A	\$134	\$163	\$133
IQS 30x30x60	\$1,485	\$1,560	\$1,634	\$111	\$297	N/A	N/A	\$134	\$163	\$133







iQ PLUS TABLES - (LAMINATE - WOOD EDGE)



	Edge Choice: Wood (Red Oak & Maple)			Wood Upgrade	OPTIONS				
	W-12	W-23 W-18 W-16	W-19 W-17 W-32	Upgrade: Walnut / Mahogany / Cherry	FLIP-TOP	POWDERCOAT UPGRADE	DELUXE CASTERS (BLK)	SPECIAL HEIGHT	
				ADD	ADD	ADD	ADD	ADD	
RECTANGLE (REC)									
IQS 24x48	\$1,869	\$2,181	\$2,492	15%	\$315	\$134	\$163	\$133	
IQS 24x60	\$1,977	\$2,307	\$2,636	15%	\$315	\$134	\$163	\$133	
IQS 24x72	\$2,085	\$2,432	\$2,780	15%	\$315	\$134	\$163	\$133	
IQS 24x84	\$2,301	\$2,684	\$3,068	15%	\$315	\$134	\$163	\$133	
IQS 24x96	\$2,301	\$2,684	\$3,068	15%	\$315	\$134	\$163	\$133	
IQS 30x48	\$1,965	\$2,293	\$2,620	15%	\$315	\$134	\$163	\$133	
IQS 30x60	\$2,094	\$2,443	\$2,792	15%	\$315	\$134	\$163	\$133	
IQS 30x72	\$2,108	\$2,459	\$2,810	15%	\$315	\$134	\$163	\$133	
IQS 30x84	\$2,480	\$2,894	\$3,307	15%	\$315	\$134	\$163	\$133	
IQS 30x96	\$2,480	\$2,894	\$3,307	15%	\$315	\$134	\$163	\$133	
HALF ROUND (HRD)									
IQS 30x60	\$2,133	\$2,489	\$2,844	15%	N/A	\$134	\$163	\$133	
QUARTER ROUND (QRD)									
IQS 30x30	\$1,860	\$2,170	\$2,480	15%	N/A	\$134	\$163	\$133	
CRESCENT (CRT)									
IQS 24x24x48	\$2,009	\$2,344	\$2,679	15%	N/A	\$134	\$163	\$133	
IQS 30x30x60	\$2,232	\$2,604	\$2,976	15%	N/A	\$134	\$163	\$133	

iQ PLUS TABLES - (VENEER)



		Edge Choice: Wood (Red Oak & Maple)			Wood Upgrade	OPTIONS				
		 V-12	 V-23	 V-19	Upgrade: Walnut / Mahogany / Cherry	FLIP-TOP	POWDERCOAT UPGRADE	DELUXE CASTERS (BLK)	SPECIAL HEIGHT	
		 V-18	 V-17	ADD						ADD
		 V-16	 V-32							
RECTANGLE (REC)										
IQS	24x48	\$1,933	\$2,126	\$2,223	15%	\$315	\$134	\$163	\$133	
IQS	24x60	\$2,211	\$2,432	\$2,543	15%	\$315	\$134	\$163	\$133	
IQS	24x72	\$2,496	\$2,746	\$2,871	15%	\$315	\$134	\$163	\$133	
IQS	24x84	\$3,067	\$3,373	\$3,527	15%	\$315	\$134	\$163	\$133	
IQS	24x96	\$3,067	\$3,373	\$3,527	15%	\$315	\$134	\$163	\$133	
IQS	30x48	\$2,189	\$2,408	\$2,517	15%	\$315	\$134	\$163	\$133	
IQS	30x60	\$2,540	\$2,794	\$2,921	15%	\$315	\$134	\$163	\$133	
IQS	30x72	\$2,891	\$3,180	\$3,325	15%	\$315	\$134	\$163	\$133	
IQS	30x84	\$3,593	\$3,952	\$4,132	15%	\$315	\$134	\$163	\$133	
IQS	30x96	\$3,593	\$3,952	\$4,132	15%	\$315	\$134	\$163	\$133	
HALF ROUND (HRD)										
IQS	30x60	\$3,090	\$3,399	\$3,554	15%	N/A	\$134	\$163	\$133	
QUARTER ROUND (QRD)										
IQS	30x30	\$2,695	\$2,964	\$3,099	15%	N/A	\$134	\$163	\$133	
CRESCENT (CRT)										
IQS	24x24x48	\$2,910	\$3,201	\$3,347	CF	N/A	\$134	\$163	\$133	
IQS	30x30x60	\$3,234	\$3,557	\$3,719	CF	N/A	\$134	\$163	\$133	

MOBI



MOBI

Mobi makes any collaborative environment a flexible environment. Mobi tables are manufactured with today's flexible settings in mind. With Berco quality and value, our goal is to provide a mobile and configurable design.

Thermofused Tops and Edges

Specially offered on our Mobi line, thermofused tops use 3D laminates, which gives a higher level of durability than standard thermofoils. It gives added impact, marring and abrasion resistance as well as improved stain resistance. The flexibility of this product eliminates the need for T-molding and edge banding as it seals itself around the top and the sides.

Table Base Specifications

FINISHES: 40+ standard powder coat finishes. Mobi bases offer the flexibility to carry 2 different colors on the same base. Custom finishes available. Please contact Customer Service for quotation.

Glides and Casters: All tables are equipped with standard 2" diameter glides. Locking casters are available as an option.

Mobi Base: Bases are equipped with powder coated 10" cast spider. Constructed of 2" (14 gauge) or 3" (16 gauge) columns from welded, flash controlled tubing. A machined solid steel center hub welded to 1 1/4" 16 gauge formed tubular steel base with welded insert to receive the casters or glides.

Mobi Table Options

There are several options available on Mobi including:

- Nesting
- Special Height
- Adjustable Height

MOBI BASE SPECIFICATIONS

End Base



Smart Code

MB1-22EB

Base Size

22"

Column Diameter

2"

Top Capacity

30"x72"

Cross Base



Smart Code

MBX-22

Base Size

22"

Column Diameter

3"

Top Capacity

24" SQ & 30" RND

MBX-28

28"

3"

30" SQ & 36" RND

MBX-32

32"

3"

36" SQ & 42" RND

MOBI TABLES - (LAMINATE & THERMO-FUSE - PVC EDGE)



		Edge Choices: PVC & T-Mold				Thermo-Fuse	Laminate Upgrades		Light Weight	OPTIONS				
		T-15	L-21	P-14	PK-2	TM-23	Laminate Upgrade I	Laminate Upgrade II	Light Weight (PVC only - 1" top)	NESTING **	POWDERCOAT UPGRADE	DELUXE CASTERS (BLK)	ADJ HEIGHT PIN	SPECIAL HEIGHT
		P-10 (self)	P-12		PK-4									
		L-15			L-23									
							ADD	ADD	ADD	ADD	ADD	ADD	ADD	ADD
SQUARE (SQR)														
MBX	24x24		\$716	\$752	\$787	\$823	\$54	\$143	\$125	N/A	\$134	\$163	N/A	\$80
MBX	30x30		\$812	\$853	\$894	\$934	\$61	\$162	\$142	N/A	\$134	\$163	N/A	\$80
MBX	36x36		\$901	\$946	\$991	\$1,036	\$68	\$180	\$158	N/A	\$134	\$163	N/A	\$80
ROUND (RND)														
MBX	24		\$745	\$782	\$820	\$857	\$56	\$149	\$130	N/A	\$134	\$163	N/A	\$80
MBX	30		\$838	\$880	\$922	\$964	\$63	\$168	\$147	N/A	\$134	\$163	N/A	\$80
MBX	36		\$950	\$997	\$1,045	\$1,092	\$71	\$190	\$166	N/A	\$134	\$163	N/A	\$80
MBX	42		\$1,048	\$1,100	\$1,153	\$1,205	\$79	\$210	\$183	N/A	\$134	\$163	N/A	\$80
RECTANGLE (REC)														
MB1	24x48		\$1,040	\$1,092	\$1,144	\$1,196	\$78	\$208	\$182	\$389	\$134	\$163	\$853	\$133
MB1	24x60		\$1,108	\$1,164	\$1,219	\$1,275	\$83	\$222	\$194	\$389	\$134	\$163	\$853	\$133
MB1	24x72		\$1,177	\$1,236	\$1,294	\$1,706	\$88	\$235	\$206	\$389	\$134	\$163	\$853	\$133
MB1	30x48		\$1,101	\$1,156	\$1,211	\$1,266	\$83	\$220	\$193	\$389	\$134	\$163	\$853	\$133
MB1	30x60		\$1,182	\$1,241	\$1,301	\$1,360	\$89	\$236	\$207	\$389	\$134	\$163	\$853	\$133
MB1	30x72		\$1,191	\$1,251	\$1,310	\$1,727	\$89	\$238	\$208	\$389	\$134	\$163	\$853	\$133
CONNECTOR (CNT)														
MB1	24x42		\$1,112	\$1,167	\$1,223	\$1,334	\$83	\$222	\$195	\$389	\$134	\$163	\$853	\$133
MB1	30x60		\$1,307	\$1,372	\$1,437	\$1,568	\$98	\$261	\$229	\$389	\$134	\$163	\$853	\$133
BEAN (BEAN)														
MB1	24x42		\$1,112	\$1,167	\$1,223	\$1,334	\$83	\$222	\$195	\$389	\$134	\$163	\$853	\$133
MB1	30x60		\$1,307	\$1,372	\$1,437	\$1,568	\$98	\$261	\$229	\$389	\$134	\$163	\$853	\$133
FAN (FAN)														
MB1	24x54		\$1,225	\$1,286	\$1,348	\$1,470	\$92	\$245	\$214	\$389	\$134	\$163	\$853	\$133
MB1	30x66		\$1,587	\$1,666	\$1,746	\$1,905	\$119	\$317	\$278	\$389	\$134	\$163	\$853	\$133

** Only Modesty Panel available with Mobi Nesting is Fabric Modesty Panel

MOBI TABLES - (LAMINATE - WOOD EDGE)



		Edge Choice: Wood (Red Oak & Maple)			Wood Upgrade	OPTIONS				
		W-12	W-23	W-19	Upgrade: Walnut / Mahogany / Cherry	NESTING **	POWDERCOAT UPGRADE	DELUXE CASTERS (BLK)	ADJ HEIGHT PIN	SPECIAL HEIGHT
			W-18	W-17	ADD	ADD	ADD	ADD	ADD	ADD
			W-16	W-32						
SQUARE (SQR)										
MBX	24x24	\$1,074	\$1,253	\$1,432	15%	N/A	\$134	\$163	N/A	\$80
MBX	30x30	\$1,219	\$1,422	\$1,625	15%	N/A	\$134	\$163	N/A	\$80
MBX	36x36	\$1,351	\$1,576	\$1,801	15%	N/A	\$134	\$163	N/A	\$80
ROUND (RND)										
MBX	24	\$1,118	\$1,304	\$1,490	15%	N/A	\$134	\$163	N/A	\$80
MBX	30	\$1,258	\$1,467	\$1,677	15%	N/A	\$134	\$163	N/A	\$80
MBX	36	\$1,425	\$1,662	\$1,899	15%	N/A	\$134	\$163	N/A	\$80
MBX	42	\$1,965	\$2,358	\$2,620	15%	N/A	\$134	\$163	N/A	\$80
RECTANGLE (REC)										
MB1	24x48	\$1,560	\$1,820	\$2,080	15%	\$389	\$134	\$163	\$853	\$133
MB1	24x60	\$1,663	\$1,940	\$2,217	15%	\$389	\$134	\$163	\$853	\$133
MB1	24x72	\$1,765	\$2,059	\$2,353	15%	\$389	\$134	\$163	\$853	\$133
MB1	30x48	\$1,651	\$1,926	\$2,201	15%	\$389	\$134	\$163	\$853	\$133
MB1	30x60	\$1,773	\$2,069	\$2,365	15%	\$389	\$134	\$163	\$853	\$133
MB1	30x72	\$1,787	\$2,084	\$2,382	15%	\$389	\$134	\$163	\$853	\$133
CONNECTOR (CNT)										
MB1	24x42	\$1,668	\$1,946	\$2,224	15%	\$389	\$134	\$163	\$853	\$133
MB1	30x60	\$1,960	\$2,287	\$2,613	15%	\$389	\$134	\$163	\$853	\$133
BEAN (BEAN)										
MB1	24x42	\$1,668	\$1,946	\$2,224	15%	\$389	\$134	\$163	\$853	\$133
MB1	30x60	\$1,960	\$2,287	\$2,613	15%	\$389	\$134	\$163	\$853	\$133
FAN (FAN)										
MB1	24x54	\$1,838	\$2,144	\$2,450	15%	\$389	\$134	\$163	\$853	\$133
MB1	30x66	\$2,381	\$2,777	\$3,174	15%	\$389	\$134	\$163	\$853	\$133

** Only Modesty Panel available with Mobi Nesting is Fabric Modesty Panel

NOMAD



NOMAD

With its unique splayed leg design, the Nomad series is a different approach to the Parson style table. Available in 30", 36", and 42" heights and lengths up to 120" as standard giving you 23 different sizes to choose from for your meeting needs. Standard top options include laminate, butcher block, and solid surface.

Table Base Specification: Finishes of 40+ Standard powdercoat finishes.

Glides and Casters: All tables are equipped with leveling glides as standard, locking casters are available as an option.

Nomad Base: Constructed of a 1.5"x 3" fully welded 14 gauge steel tubing legs with a 6" x 6" x 1/8" thick top plate to attach to your worktop. Each table includes a foot rest/cross bar to insure structural integrity.

NOMAD TABLES - (LAMINATE - PVC EDGE)	NOMAD TABLES - (1-1/2" BUTCHERBLOCK)
--------------------------------------	--------------------------------------

	Edge Choices: PVC & T-Mold				Laminate Upgrades		OPTIONS			Standard	Wood Upgrade	OPTIONS		
	T-15	L-21	P-14	PK-2	Laminate Upgrade I	Laminate Upgrade II	36" Height	42" Height	CASTERS	Red Oak	Maple	36" Height	42" Height	CASTERS
	P-10 (self)	P-12		PK-4	ADD	ADD	ADD	ADD	ADD		ADD	ADD	ADD	ADD
	L-15			L-23										
RECTANGLE (REC)														
NOM 24x48	\$2,869		\$3,012	\$3,155	\$215	\$574	\$450	\$450	\$240	\$3,418	15%	\$450	\$450	\$240
NOM 24x60	\$3,100		\$3,255	\$3,410	\$233	\$620	\$450	\$450	\$240	\$3,794	15%	\$450	\$450	\$240
NOM 24x72	\$3,172		\$3,330	\$3,489	\$238	\$634	\$450	\$450	\$240	\$3,999	15%	\$450	\$450	\$240
NOM 24x84	\$3,477		\$3,651	\$3,825	\$261	\$695	\$450	\$450	\$240	\$4,780	15%	\$450	\$450	\$240
NOM 24x96	\$3,548		\$3,726	\$3,903	\$266	\$710	\$450	\$450	\$240	\$4,780	15%	\$450	\$450	\$240
NOM 30x48	\$3,093		\$3,247	\$3,402	\$232	\$619	\$450	\$450	\$240	\$3,746	15%	\$450	\$450	\$240
NOM 30x60	\$3,178		\$3,337	\$3,496	\$238	\$636	\$450	\$450	\$240	\$4,017	15%	\$450	\$450	\$240
NOM 30x72	\$3,188		\$3,347	\$3,507	\$239	\$638	\$450	\$450	\$240	\$4,251	15%	\$450	\$450	\$240
NOM 30x84	\$3,582		\$3,761	\$3,940	\$269	\$716	\$450	\$450	\$240	\$5,195	15%	\$450	\$450	\$240
NOM 30x96	\$3,669		\$3,852	\$4,035	\$275	\$734	\$450	\$450	\$240	\$5,195	15%	\$450	\$450	\$240
NOM 36x60	\$3,429		\$3,601	\$3,772	\$257	\$686	\$450	\$450	\$240	\$4,425	15%	\$450	\$450	\$240
NOM 36x72	\$3,530		\$3,706	\$3,883	\$265	\$706	\$450	\$450	\$240	\$4,702	15%	\$450	\$450	\$240
NOM 36x84	\$3,863		\$4,056	\$4,249	\$290	\$773	\$450	\$450	\$240					
NOM 36x96	\$3,789		\$3,978	\$4,168	\$284	\$758	\$450	\$450	\$240					
NOM 42x60	\$3,751		\$3,939	\$4,126	\$281	\$750	\$450	\$450	\$240					
NOM 42x72	\$3,865		\$4,058	\$4,252	\$290	\$773	\$450	\$450	\$240					
NOM 42x84	\$4,212		\$4,423	\$4,633	\$316	\$842	\$450	\$450	\$240					
NOM 42x96	\$4,326		\$4,542	\$4,759	\$324	\$865	\$450	\$450	\$240					
NOM 42 x 120 (3 bases)	\$6,066		\$6,370	\$6,673	\$455	\$1,213	\$660	\$660	\$360					
NOM 48x72	\$4,376		\$4,595	\$4,814	\$328	\$875	\$450	\$450	\$240					
NOM 48x84	\$4,737		\$4,973	\$5,210	\$355	\$947	\$450	\$450	\$240					
NOM 48x96	\$4,864		\$5,108	\$5,351	\$365	\$973	\$450	\$450	\$240					
NOM 48 x 120 (3 bases)	\$6,841		\$7,183	\$7,526	\$513	\$1,368	\$660	\$660	\$360					

PALISADE



PALISADE

Palisade Tables are manufactured with Berco's goal of quality and value and are ideally suited for use in a myriad of settings including corporate training rooms, cafeterias, educational settings and healthcare environments. Your choice of options make our Palisade tables adapt to your specific requirements.

Table Pedestal Specifications Finishes: Available in textured standard powder coat finishes. Custom finishes available. Please contact Customer Service for quotation.

Construction: Made with a 1 1/4" 16 gauge cold rolled steel tubing welded to a 6 X 6.2" thick steel mounting plate designed to place the legs into the corner of the tops. For tops greater than 48" length, a table stiffener is added to diminish the possibility of top warpage. Legs are shipped, assembled, and ready to attach to the tops.

Glides and Casters: All tables are equipped with 2" diameter glides with brushed stainless steel cover over black plastic foot. The stem is M10 and 15mm long. The glide is suitable for carpet, as well as hard floors. Our high quality twin wheel locking casters are offered as an option.

PALISADE BASE SPECIFICATIONS

Pedestal



Smart Code

PAL-1

Base Size

N/A

Column Diameter

1 ¼"

Top Capacity

Distance Between Legs
Over 48" Up To 72"
Requires Stiffener

PALISADE DESIGN OPTIONS

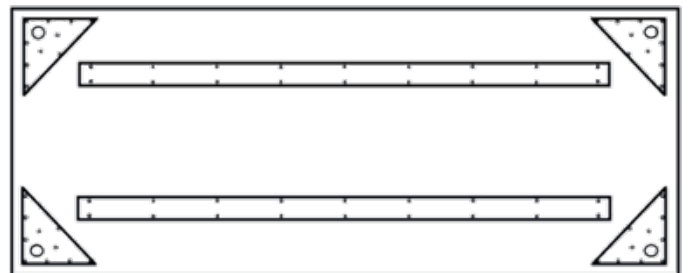
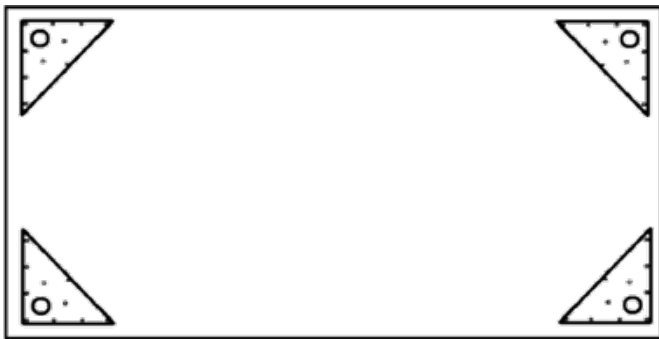
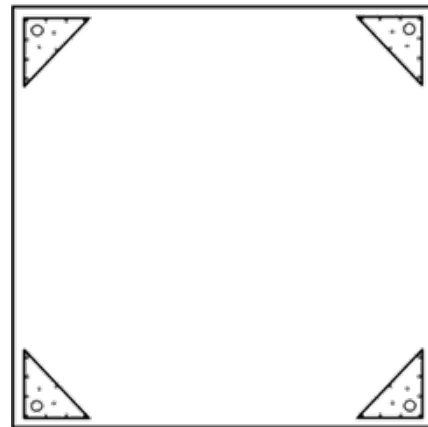
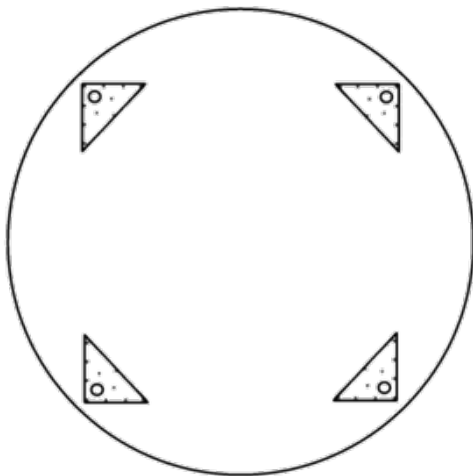

PALISADE TABLES - (LAMINATE - PVC EDGE)

Limited Base Finish Options - Textured Only



Edge Choice: PVC & T-Mold		Laminate Upgrades		Light Weight	OPTIONS				
		Laminate Upgrade I	Laminate Upgrade II	(PVC only - 1" top)	DELUXE CASTERS (BLK)	EQUALIZER GLIDES	UPGRADE FINISH (5 TABLES MIN.)		
		ADD	ADD	ADD	ADD	ADD	ADD		
SQUARE (SQR)									
PAL	30x30	\$703	\$738	\$53	\$141	\$123	\$163	\$61	\$135
PAL	36x36	\$796	\$836	\$60	\$159	\$139	\$163	\$61	\$135
PAL	42x42	\$903	\$948	\$68	\$181	\$158	\$163	\$61	\$135
ROUND (RND)									
PAL	36	\$820	\$861	\$61	\$164	\$143	\$163	\$61	\$135
PAL	42	\$923	\$969	\$69	\$185	\$162	\$163	\$61	\$135
PAL	48	\$1,041	\$1,093	\$78	\$208	\$182	\$163	\$61	\$135
RECTANGLE (REC)									
PAL	18x36	\$636	\$667	\$48	\$127	\$111	N/A	\$61	\$135
PAL	18x42	\$669	\$702	\$50	\$134	\$117	N/A	\$61	\$135
PAL	18x48	\$704	\$739	\$53	\$141	\$123	N/A	\$61	\$135
PAL	18x60	\$995	\$1,045	\$75	\$199	\$174	N/A	\$61	\$135
PAL	18x72	\$1,286	\$1,350	\$96	\$257	\$225	N/A	\$61	\$135
PAL	24x36	\$696	\$731	\$52	\$139	\$122	\$163	\$61	\$135
PAL	24x42	\$732	\$769	\$55	\$146	\$128	\$163	\$61	\$135
PAL	24x48	\$768	\$807	\$58	\$154	\$134	\$163	\$61	\$135
PAL	24x60	\$1,073	\$1,127	\$80	\$215	\$188	\$163	\$61	\$135
PAL	24x72	\$1,378	\$1,446	\$103	\$276	\$241	\$163	\$61	\$135
PAL	30x36	\$746	\$783	\$56	\$149	\$131	\$163	\$61	\$135
PAL	30x42	\$789	\$828	\$59	\$158	\$138	\$163	\$61	\$135
PAL	30x48	\$832	\$874	\$62	\$166	\$146	\$163	\$61	\$135
PAL	30x60	\$1,151	\$1,208	\$86	\$230	\$201	\$163	\$61	\$135
PAL	30x72	\$1,393	\$1,462	\$104	\$279	\$244	\$163	\$61	\$135

PLATEAU TABLES



PLATEAU

The Plateau table series is designed to create an elegant but functional base for your tables. With its low profile square disk base design and square column it has a look designed for today's environments.

Table Base Specifications:

Finishes: Offered in 40+ standard powder coat finishes.

Glides: All tables are equipped with 1" diameter leveling glides with a plastic foot that can be used on all floor surfaces that allow ¼" of adjustment.

Base Specifications: Bases feature 3/8" thick steel plate with 4 adjustable glides that has a 10.50 mm corner radius. The column is a 3"x 3" square tube with a 9" x 9" flat top plate to attach to table tops. Standard base dimensions are 17", 22", and 27" square.

PLATEAU TABLES - (LAMINATE - PVC EDGE)



		Edge Choices: PVC & T-Mold				Laminate Upgrades		Light Weight	OPTIONS			BASE SIZE (QTY)
		T-15	L-21	P-14	PK-2	Laminate Upgrade I	Laminate Upgrade II	Light Weight (PVC only - 1" top)	POWDERCOAT UPGRADE	ELECTRICAL CUTOUTS	STANDING HEIGHT	
		P-10 (self)	P-12		PK-4	ADD	ADD	ADD	ADD	ADD	ADD	
		L-15			L-23							
SQUARE (SQR)												
PLX	24x24	\$1,032	\$1,084	\$1,135	\$77	\$206	\$181	\$134	\$260	\$80	17x17 (1)	
PLX	30x30	\$1,110	\$1,166	\$1,222	\$83	\$222	\$194	\$134	\$260	\$80	17x17 (1)	
PLX	36x36	\$1,411	\$1,482	\$1,552	\$106	\$282	\$247	\$134	\$260	\$80	22x22 (1)	
PLX	42x42	\$1,518	\$1,594	\$1,670	\$114	\$304	\$266	\$134	\$260	\$80	22x22 (1)	
ROUND (RND)												
PLX	24	\$1,063	\$1,116	\$1,169	\$80	\$213	\$186	\$134	\$260	\$80	17x17 (1)	
PLX	30	\$1,138	\$1,194	\$1,251	\$85	\$228	\$199	\$134	\$260	\$80	17x17 (1)	
PLX	36	\$1,227	\$1,288	\$1,350	\$92	\$245	\$215	\$134	\$260	\$80	17x17 (1)	
PLX	42	\$1,538	\$1,615	\$1,692	\$115	\$308	\$269	\$134	\$260	\$80	22x22 (1)	
PLX	48	\$1,439	\$1,511	\$1,583	\$108	\$288	\$252	\$134	\$260	\$80	27x27 (1)	
RECTANGLE (REC)												
PLX	24x48	\$1,383	\$1,452	\$1,521	\$104	\$277	\$242	\$134	\$260	\$80	22x22 (1)	
PLX	24x60	\$1,969	\$2,068	\$2,166	\$148	\$394	\$345	\$268	\$260	\$161	17x17 (2)	
PLX	24x72	\$2,041	\$2,143	\$2,245	\$153	\$408	\$357	\$268	\$260	\$161	17x17 (2)	
PLX	30x48	\$1,446	\$1,519	\$1,591	\$108	\$289	\$253	\$134	\$260	\$80	22x22 (1)	
PLX	30x60	\$2,048	\$2,150	\$2,252	\$154	\$410	\$358	\$268	\$260	\$161	17x17 (2)	
PLX	30x72	\$2,057	\$2,160	\$2,263	\$154	\$411	\$360	\$268	\$260	\$161	17x17 (2)	
PLX	36x48	\$2,440	\$2,562	\$2,684	\$183	\$488	\$427	\$268	\$260	\$161	22x22 (2)	
PLX	36x60	\$2,539	\$2,666	\$2,793	\$190	\$508	\$444	\$268	\$260	\$161	22x22 (2)	
PLX	36x72	\$2,639	\$2,771	\$2,903	\$198	\$528	\$462	\$268	\$260	\$161	22x22 (2)	

PLATEAU TABLES - (LAMINATE - WOOD EDGE)



		Edge Choice: Wood (Red Oak & Maple)			Wood Upgrade	OPTIONS			BASE SIZE (QTY)
		W-12	W-23 W-18 W-16	W-19 W-17 W-32	Upgrade: Walnut / Mahogany / Cherry	POWDERCOAT UPGRADE	ELECTRICAL CUTOUTS	STANDING HEIGHT	
					ADD	ADD	ADD	ADD	
SQUARE (SQR)									
PLX	24x24	\$1,548	\$1,806	\$2,064	15%	\$134	\$260	\$80	17x17 (1)
PLX	30x30	\$1,666	\$1,943	\$2,221	15%	\$134	\$260	\$80	17x17 (1)
PLX	36x36	\$2,117	\$2,469	\$2,822	15%	\$134	\$260	\$80	22x22 (1)
PLX	42x42	\$2,846	\$3,416	\$3,795	15%	\$134	\$260	\$80	22x22 (1)
ROUND (RND)									
PLX	24	\$1,595	\$1,860	\$2,126	15%	\$134	\$260	\$80	17x17 (1)
PLX	30	\$1,706	\$1,991	\$2,275	15%	\$134	\$260	\$80	17x17 (1)
PLX	36	\$1,840	\$2,147	\$2,454	15%	\$134	\$260	\$80	17x17 (1)
PLX	42	\$2,885	\$3,461	\$3,846	15%	\$134	\$260	\$80	22x22 (1)
PLX	48	\$2,698	\$3,238	\$3,598	15%	\$134	\$260	\$80	27x27 (1)
RECTANGLE (REC)									
PLX	24x48	\$2,593	\$3,111	\$3,457	15%	\$134	\$260	\$80	22x22 (1)
PLX	24x60	\$3,692	\$4,430	\$4,923	15%	\$268	\$260	\$161	17x17 (2)
PLX	24x72	\$3,827	\$4,592	\$5,102	15%	\$268	\$260	\$161	17x17 (2)
PLX	30x48	\$2,712	\$3,254	\$3,616	15%	\$134	\$260	\$80	22x22 (1)
PLX	30x60	\$3,839	\$4,607	\$5,119	15%	\$268	\$260	\$161	17x17 (2)
PLX	30x72	\$3,857	\$4,629	\$5,143	15%	\$268	\$260	\$161	17x17 (2)
PLX	36x48	\$4,576	\$5,491	\$6,101	15%	\$268	\$260	\$161	22x22 (2)
PLX	36x60	\$4,761	\$5,713	\$6,348	15%	\$268	\$260	\$161	22x22 (2)
PLX	36x72	\$4,949	\$5,939	\$6,599	15%	\$198	\$260	\$161	22x22 (2)

PLATEAU TABLES - (VENEER)



		Edge Choice: Wood (Red Oak & Maple)			Wood Upgrade	OPTIONS			BASE SIZE (QTY)
		V-12	V-23 V-18 V-16	V-19 V-17 V-32	Upgrade: Walnut / Mahogany / Cherry	POWDERCOAT UPGRADE	ELECTRICAL CUTOUPS	STANDING HEIGHT	
					ADD	ADD	ADD	ADD	
SQUARE (SQR)									
PLX	24x24	\$2,167	\$2,384	\$2,492	15%	\$134	\$260	\$80	17x17 (1)
PLX	30x30	\$2,332	\$2,565	\$2,682	15%	\$134	\$260	\$80	17x17 (1)
PLX	36x36	\$2,963	\$3,260	\$3,408	15%	\$134	\$260	\$80	22x22 (1)
PLX	42x42	\$3,985	\$4,384	\$4,583	15%	\$134	\$260	\$80	22x22 (1)
ROUND (RND)									
PLX	24	\$2,232	\$2,456	\$2,567	15%	\$134	\$260	\$80	17x17 (1)
PLX	30	\$2,389	\$2,628	\$2,747	15%	\$134	\$260	\$80	17x17 (1)
PLX	36	\$2,577	\$2,834	\$2,963	15%	\$134	\$260	\$80	17x17 (1)
PLX	42	\$4,038	\$4,442	\$4,644	15%	\$134	\$260	\$80	22x22 (1)
PLX	48	\$3,777	\$4,155	\$4,344	15%	\$134	\$260	\$80	27x27 (1)
RECTANGLE (REC)									
PLX	24x48	\$3,630	\$3,993	\$4,174	15%	\$134	\$260	\$80	22x22 (1)
PLX	24x60	\$5,169	\$5,686	\$5,944	15%	\$268	\$260	\$161	17x17 (2)
PLX	24x72	\$5,357	\$5,893	\$6,161	15%	\$268	\$260	\$161	17x17 (2)
PLX	30x48	\$3,797	\$4,176	\$4,366	15%	\$134	\$260	\$80	22x22 (1)
PLX	30x60	\$5,375	\$5,913	\$6,181	15%	\$268	\$260	\$161	17x17 (2)
PLX	30x72	\$5,400	\$5,940	\$6,210	15%	\$268	\$260	\$161	17x17 (2)
PLX	36x48	\$6,406	\$7,047	\$7,367	15%	\$268	\$260	\$161	22x22 (2)
PLX	36x60	\$6,665	\$7,332	\$7,665	15%	\$268	\$260	\$161	22x22 (2)
PLX	36x72	\$6,929	\$7,621	\$7,968	15%	\$198	\$260	\$161	22x22 (2)

SENSE



SENSE - QUICK SHIP PROGRAM

Berco's Quick Ship Program is designed to meet the requirements of an "immediate demand" table. Berco utilizes its Sense tables for the Quick Ship program.

Table Pedestal Specifications

Finish: Available in black wrinkle powder coat finish.

Glides and Casters: All tables are equipped with 1" diameter stainless steel, rubber cushioned glides with 1" long stem secured with full threaded rivets to maintain stability. Optional casters available at an additional charge.

Stationary Table Pedestals

Constructed of 2" 14 gauge, steel tubing with welded end caps. Factory welded .2" thick, 6" x 8" steel mounting plate. The column and base are welded together at the factory. End bases are shipped assembled, cross bases require simple assembly.

Quick Ship Program Details

- Tables ship within 15 working days of order confirmation.
- Up to 30 tables shipped to any single shipping address.

Quick Ship Laminate Choices:

- Graphite Nebula 4623-60
- Grey Nebula 4622-60
- Wild Cherry 7054-60
- Designer White D354-60
- Desert Zephyr 4841-60

Quick Ship Edge Choices (3mm PVC only):

- E02 Raincloud
- E06 Graphite
- E10 Ebony
- E11 Snow
- E13 Wild Cherry

Quick Ship Base Color:

- T05 Black Wrinkle

Quick Ship Table Sizes:

- Square: 36"x36" / 42"x42"
- Round: 36" / 42"
- Rectangle: 24"x48" / 24"x60" / 24"x72" / 30"x48" / 30"x60" / 30"x72" / 36"x48" / 36"x60" / 36"x72"

SENSE QUICK SHIP TABLES



TOP: LAMINATE		
PVC EDGE	OPTIONS	
TABLE	DELUXE CASTERS (BLK)	
	ADD	
SQUARE (SQR)		
QS-SNX 36x36	\$709	\$163
QS-SNX 42x42	\$871	\$163
ROUND (RND)		
QS-SNX 36	\$731	\$163
QS-SNX 42	\$829	\$163
RECTANGLE (REC)		
QS-SN1 24x48	\$695	\$163
QS-SN1 24x60	\$767	\$163
QS-SN1 24x72	\$839	\$163
QS-SN1 30x48	\$842	\$163
QS-SN1 30x60	\$928	\$163
QS-SN1 30x72	\$938	\$163
QS-SN1 36x48	\$906	\$163
QS-SN1 36x60	\$1,006	\$163
QS-SN1 36x72	\$1,106	\$163

Laminate Color Options

- Graphite Nebula 4623-60
- Grey Nebula 4622-60
- Wild Cherry 7054-60
- Designer White D354-60
- Desert Zephyr 4841-60

Edge Choices (3MM PVC)

- E02 Raincloud
- E06 Graphite
- E10 Ebony
- E11 Snow
- E13 Wild Cherry

Base Color

- T05 Black Wrinkle

Program Details

Tables ship within 15 working days of order confirmation.
Up to 30 tables shipped to any single shipping address.

SENSE

Sense tables are designed to meet the opportunities where a “bid to win” product is needed. Its simple look, limited options and colors, and rugged construction, make it the perfect choice when basic tables are required.

Table Pedestal Specifications

Finishes: Available in 5 standard wrinkle powder coat finishes.

Glides and Casters: All tables are equipped with 1” diameter stainless steel, rubber cushioned glides with 1” long stem secured with full threaded rivets to maintain stability. Optional styles of glides and casters available at an additional charge.

Stationary Table Pedestals

Constructed of 2” 14 gauge, steel tubing with welded end caps. Factory welded .2” thick, 6” x 8” steel mounting plate. The column and base are welded together at the factory. End bases are shipped assembled, cross bases require simple assembly.

Sense Folding Table Leg Specifications

Our patented spring loaded folding mechanism is fully riveted to a steel mounting plate. Vinyl bumpers are integrated into the mechanism allowing for a non-marring, 3-1/2” stacking height. Equipped with molded release handle and integral catch that holds leg in folded position. Folding legs are constructed of welded, rolled steel tubing with MIG welded end caps, polished for seamless appearance.

Sense Table Options

There are several options available on Sense including:

- Nesting
- Folding
- Flip Top
- Special Height

SENSE BASE SPECIFICATIONS

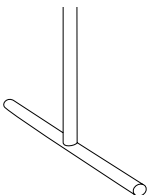
<u>End Base</u>	<u>Smart Code</u>	<u>Base Size</u>	<u>Column Diameter</u>	<u>Top Capacity</u>
	SN1-16EB	16”	2”	18”x96”
	SN1-20EB	20”	2”	24”x96”
	SN1-26EB	26”	2”	36”x96”

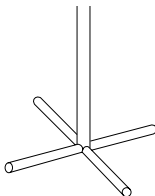
<u>Cross Base</u>	<u>Smart Code</u>	<u>Base Size</u>	<u>Column Diameter</u>	<u>Top Capacity</u>
	SNX-22	22”	3”	24” SQ & RND
	SNX-26	26”	3”	30” SQ & RND
	SNX-32	32”	3”	36” SQ & 42” RND
	SNX-38	38”	4”	42” SQ & 60” RND

SENSE TABLES - (LAMINATE - PVC EDGE)

Limited Base Finish Options - Textured Only



		Edge Choices: PVC & T-Mold				Laminate Upgrades		Light Weight	OPTIONS						
						Laminate Upgrade I	Laminate Upgrade II	Light Weight (PVC only - 1" top)	NESTING	FOLDING	FLIP TOP	DELUXE CASTERS (BLK)	EQUALIZER GLIDES	UPGRADE FINISH (5 TABLES MIN.)	SPECIAL HEIGHT
						ADD	ADD	ADD	ADD	ADD	ADD	ADD	ADD	ADD	ADD
SQUARE (SQR)															
SNX	24x24	\$538	\$565	\$592	\$40	\$108	\$94	N/A	N/A	\$112	\$163	\$61	\$102	\$80	
SNX	30x30	\$618	\$649	\$679	\$46	\$124	\$108	N/A	N/A	\$112	\$163	\$61	\$102	\$80	
SNX	36x36	\$709	\$744	\$779	\$53	\$142	\$124	N/A	N/A	\$112	\$163	\$61	\$102	\$80	
SNX	42x42	\$871	\$914	\$958	\$65	\$174	\$152	N/A	N/A	\$112	\$163	\$61	\$102	\$80	
SNX	48x48	\$986	\$1,035	\$1,084	\$74	\$197	\$172	N/A	N/A	N/A	\$163	\$61	\$102	\$80	
ROUND (RND)															
SNX	24	\$567	\$596	\$624	\$43	\$113	\$99	N/A	N/A	\$112	\$163	\$61	\$102	\$80	
SNX	30	\$644	\$676	\$708	\$48	\$129	\$113	N/A	N/A	\$112	\$163	\$61	\$102	\$80	
SNX	36	\$731	\$768	\$804	\$55	\$146	\$128	N/A	N/A	\$112	\$163	\$61	\$102	\$80	
SNX	42	\$829	\$871	\$912	\$62	\$166	\$145	N/A	N/A	\$112	\$163	\$61	\$102	\$80	
SNX	48	\$1,002	\$1,052	\$1,102	\$75	\$200	\$175	N/A	N/A	\$112	\$163	\$61	\$102	\$80	
SNX	54	\$1,127	\$1,183	\$1,239	\$84	\$225	\$197	N/A	N/A	N/A	\$163	\$61	\$102	\$80	
SNX	60	\$1,264	\$1,328	\$1,391	\$95	\$253	\$221	N/A	N/A	N/A	\$163	\$61	\$102	\$80	
RECTANGLE (REC)															
SN1	18x48	\$625	\$656	\$688	\$47	\$125	\$109	\$389	N/A	N/A	\$163	\$61	\$135	\$133	
SN1	18x60	\$683	\$717	\$751	\$51	\$137	\$120	\$389	\$424	N/A	\$163	\$61	\$135	\$133	
SN1	18x72	\$741	\$778	\$815	\$56	\$148	\$130	\$389	\$424	N/A	\$163	\$61	\$135	\$133	
SN1	18x84	\$799	\$839	\$879	\$60	\$160	\$140	\$389	\$424	N/A	\$163	\$61	\$135	\$133	
SN1	18x96	\$857	\$900	\$943	\$64	\$171	\$150	\$389	\$424	N/A	\$163	\$61	\$135	\$133	
SN1	24x30	\$587	\$616	\$646	\$44	\$117	\$103	\$389	N/A	N/A	\$163	\$61	\$135	\$133	
SN1	24x36	\$623	\$654	\$685	\$47	\$125	\$109	\$389	N/A	N/A	\$163	\$61	\$135	\$133	
SN1	24x42	\$659	\$692	\$725	\$49	\$132	\$115	\$389	N/A	N/A	\$163	\$61	\$135	\$133	
SN1	24x48	\$695	\$730	\$764	\$52	\$139	\$122	\$389	N/A	N/A	\$163	\$61	\$135	\$133	
SN1	24x60	\$767	\$805	\$844	\$58	\$153	\$134	\$389	\$424	N/A	\$163	\$61	\$135	\$133	
SN1	24x72	\$839	\$881	\$923	\$63	\$168	\$147	\$389	\$424	N/A	\$163	\$61	\$135	\$133	
SN1	24x84	\$911	\$956	\$1,002	\$68	\$182	\$159	\$389	\$424	N/A	\$163	\$61	\$135	\$133	
SN1	24x96	\$983	\$1,032	\$1,081	\$74	\$197	\$172	\$389	\$424	N/A	\$163	\$61	\$135	\$133	
SN1	24x120 (1 piece)	\$1,247	\$1,309	\$1,372	\$94	\$249	N/A	N/A	N/A	N/A	\$244	\$91	\$135	\$133	
SN1	24x144 (1 piece)	\$1,391	\$1,460	\$1,530	\$104	\$278	N/A	N/A	N/A	N/A	\$244	\$91	\$135	\$133	
SN1	30x36	\$757	\$794	\$832	\$57	\$151	\$132	\$389	N/A	N/A	\$163	\$61	\$135	\$133	
SN1	30x42	\$800	\$839	\$879	\$60	\$160	\$140	\$389	N/A	N/A	\$163	\$61	\$135	\$133	
SN1	30x48	\$842	\$885	\$927	\$63	\$168	\$147	\$389	N/A	N/A	\$163	\$61	\$135	\$133	
SN1	30x60	\$928	\$975	\$1,021	\$70	\$186	\$162	\$389	\$424	N/A	\$163	\$61	\$135	\$133	
SN1	30x72	\$938	\$984	\$1,031	\$70	\$188	\$164	\$389	\$424	N/A	\$163	\$61	\$135	\$133	
SN1	30x84	\$1,100	\$1,155	\$1,210	\$83	\$220	\$193	\$389	\$424	N/A	\$163	\$61	\$135	\$133	
SN1	30x96	\$1,186	\$1,245	\$1,305	\$89	\$237	\$208	\$389	\$424	N/A	\$163	\$61	\$135	\$133	
SN1	30x120 (1 piece)	\$1,520	\$1,596	\$1,672	\$114	\$304	N/A	N/A	N/A	N/A	\$244	\$91	\$135	\$133	
SN1	30x144 (1 piece)	\$1,692	\$1,776	\$1,861	\$127	\$338	N/A	N/A	N/A	N/A	\$244	\$91	\$135	\$133	
SN1	36x42	\$856	\$899	\$942	\$64	\$171	\$150	\$389	N/A	N/A	\$163	\$61	\$135	\$133	
SN1	36x48	\$906	\$952	\$997	\$68	\$181	\$159	\$389	N/A	N/A	\$163	\$61	\$135	\$133	
SN1	36x60	\$1,006	\$1,056	\$1,107	\$75	\$201	\$176	\$389	\$424	N/A	\$163	\$61	\$135	\$133	
SN1	36x72	\$1,106	\$1,161	\$1,217	\$83	\$221	\$194	\$389	\$424	N/A	\$163	\$61	\$135	\$133	
SN1	36x84	\$1,206	\$1,266	\$1,326	\$90	\$241	\$211	\$389	\$424	N/A	\$163	\$61	\$135	\$133	

SENSE TABLES - (LAMINATE - PVC EDGE)

Limited Base Finish Options - Textured Only









		Edge Choices: PVC & T-Mold				Laminate Upgrades		Light Weight	OPTIONS						
		T-15	L-21	P-14	PK-2	Laminate Upgrade I	Laminate Upgrade II	Light Weight (PVC only - 1" top)	NESTING	FOLDING	FLIP TOP	DELUXE CASTERS (BLK)	EQUALIZER GLIDES	UPGRADE FINISH (5 TABLES MIN.)	SPECIAL HEIGHT
		P-10 (self)	P-12		PK-4	ADD	ADD	ADD	ADD	ADD	ADD	ADD	ADD	ADD	ADD
		L-15			L-23										
SN1	36x96	\$1,306	\$1,371	\$1,436	\$98	\$261	\$228	\$389	\$424	N/A	\$163	\$61	\$135	\$133	
SN1	36x120 (1 piece)	\$1,668	\$1,751	\$1,834	\$125	\$334	N/A	N/A	N/A	N/A	\$244	\$91	\$135	\$133	
SN1	36x144 (1 piece)	\$1,867	\$1,961	\$2,054	\$140	\$373	N/A	N/A	N/A	N/A	\$244	\$91	\$135	\$133	
RACETRACK (RAC)															
SN1	36x72	\$1,195	\$1,255	\$1,315	\$90	\$239	\$209	\$389	\$313	N/A	\$163	\$61	\$135	\$133	
SN1	36x84	\$1,295	\$1,360	\$1,425	\$97	\$259	\$227	\$389	\$313	N/A	\$163	\$61	\$135	\$133	
SN1	36x96	\$1,395	\$1,465	\$1,535	\$105	\$279	\$244	\$389	\$313	N/A	\$163	\$61	\$135	\$133	
OVAL (OVL)															
SN1	36x60	\$1,096	\$1,150	\$1,205	\$82	\$219	\$192	\$389	N/A	N/A	\$163	\$61	\$135	\$133	
SN1	36x72	\$1,195	\$1,255	\$1,315	\$90	\$239	\$209	\$389	\$313	N/A	\$163	\$61	\$135	\$133	
SN1	36x84	\$1,295	\$1,360	\$1,425	\$97	\$259	\$227	\$389	\$313	N/A	\$163	\$61	\$135	\$133	
SN1	36x96	\$1,395	\$1,465	\$1,535	\$105	\$279	\$244	\$389	\$313	N/A	\$163	\$61	\$135	\$133	
TRAPEZOID (TRP)															
SN1	24x24x48	\$778	\$817	\$856	\$58	\$156	\$136	\$389	N/A	N/A	\$163	\$61	\$135	\$133	
SN1	24x36x60	\$1,006	\$1,056	\$1,106	\$75	\$201	\$176	\$389	N/A	N/A	\$163	\$61	\$135	\$133	
SN1	30x30x60	\$934	\$981	\$1,028	\$70	\$187	\$163	\$389	N/A	N/A	\$163	\$61	\$135	\$133	
SN1	30x42x72	\$1,204	\$1,264	\$1,324	\$90	\$241	\$211	\$389	N/A	N/A	\$163	\$61	\$135	\$133	
SN1	36x36x72	\$1,195	\$1,255	\$1,315	\$90	\$239	\$209	\$389	N/A	N/A	\$163	\$61	\$135	\$133	
HALF ROUND (HRD)															
SN1	24x48	\$720	\$756	\$792	\$54	\$144	\$126	\$389	N/A	N/A	\$163	\$61	\$135	\$133	
SN1	30x60	\$872	\$916	\$959	\$65	\$174	\$153	\$389	N/A	N/A	\$163	\$61	\$135	\$133	
SN1	36x72	\$1,130	\$1,186	\$1,243	\$85	\$226	\$198	\$389	N/A	N/A	\$163	\$61	\$135	\$133	
QUARTER ROUND (QRD)															
SN1	24x24	\$590	\$619	\$649	\$44	\$118	\$103	N/A	N/A	N/A	\$163	\$61	\$135	\$133	
SN1	30x30	\$675	\$708	\$742	\$51	\$135	\$118	N/A	N/A	N/A	\$163	\$61	\$135	\$133	
SN1	36x36	\$851	\$894	\$936	\$64	\$170	\$149	N/A	N/A	N/A	\$163	\$61	\$135	\$133	
CRESCENT (CRT)															
SN1	24x24x48	\$784	\$824	\$863	\$59	\$157	\$137	\$389	N/A	N/A	\$163	\$61	\$135	\$133	
SN1	30x30x60	\$1,018	\$1,069	\$1,119	\$76	\$204	\$178	\$389	N/A	N/A	\$163	\$61	\$135	\$133	
SN1	36x36x72	\$1,195	\$1,255	\$1,315	\$90	\$239	\$209	\$389	N/A	N/A	\$163	\$61	\$135	\$133	

SENSE TABLES - (LAMINATE - WOOD EDGE)

Limited Base Finish Options - Textured Only



		Edge Choice: Wood (Red Oak & Maple)			Wood Upgrade	OPTIONS						
					Upgrade: Walnut / Mahogany / Cherry	NESTING	FOLDING	FLIP TOP	DELUXE CASTERS (BLK)	EQUALIZER GLIDES	UPGRADE FINISH (5 TABLES MIN.)	SPECIAL HEIGHT
												
SQUARE (SQR)												
SNX	24x24	\$807	\$941	\$1,076	15%	N/A	N/A	\$112	\$163	\$61	\$102	\$80
SNX	30x30	\$927	\$1,081	\$1,235	15%	N/A	N/A	\$112	\$163	\$61	\$102	\$80
SNX	36x36	\$1,063	\$1,240	\$1,417	15%	N/A	N/A	\$112	\$163	\$61	\$102	\$80
SNX	42x42	\$1,633	\$1,960	\$2,177	15%	N/A	N/A	\$112	\$163	\$61	\$102	\$80
SNX	48x48	\$1,848	\$2,218	\$2,464	15%	N/A	N/A	N/A	\$163	\$61	\$102	\$80
ROUND (RND)												
SNX	24	\$851	\$993	\$1,134	15%	N/A	N/A	\$112	\$163	\$61	\$102	\$80
SNX	30	\$966	\$1,127	\$1,287	15%	N/A	N/A	\$112	\$163	\$61	\$102	\$80
SNX	36	\$1,097	\$1,280	\$1,463	15%	N/A	N/A	\$112	\$163	\$61	\$102	\$80
SNX	42	\$1,555	\$1,866	\$2,074	15%	N/A	N/A	\$112	\$163	\$61	\$102	\$80
SNX	48	\$1,878	\$2,254	\$2,505	15%	N/A	N/A	\$112	\$163	\$61	\$102	\$80
SNX	54	\$2,112	\$2,535	\$2,816	15%	N/A	N/A	N/A	\$163	\$61	\$102	\$80
SNX	60	\$2,371	\$2,845	\$3,161	15%	N/A	N/A	N/A	\$163	\$61	\$102	\$80
RECTANGLE (REC)												
SN1	18x48	\$938	\$1,094	\$1,250	15%	\$389	N/A	N/A	\$163	\$61	\$135	\$133
SN1	18x60	\$1,024	\$1,195	\$1,366	15%	\$389	\$424	N/A	\$163	\$61	\$135	\$133
SN1	18x72	\$1,111	\$1,297	\$1,482	15%	\$389	\$424	N/A	\$163	\$61	\$135	\$133
SN1	18x84	\$1,285	\$1,499	\$1,714	15%	\$389	\$424	N/A	\$163	\$61	\$135	\$133
SN1	18x96	\$1,285	\$1,499	\$1,714	15%	\$389	\$424	N/A	\$163	\$61	\$135	\$133
SN1	24x30	\$881	\$1,027	\$1,174	15%	\$389	N/A	N/A	\$163	\$61	\$135	\$133
SN1	24x36	\$935	\$1,090	\$1,246	15%	\$389	N/A	N/A	\$163	\$61	\$135	\$133
SN1	24x42	\$989	\$1,153	\$1,318	15%	\$389	N/A	N/A	\$163	\$61	\$135	\$133
SN1	24x48	\$1,042	\$1,216	\$1,390	15%	\$389	N/A	N/A	\$163	\$61	\$135	\$133
SN1	24x60	\$1,150	\$1,342	\$1,534	15%	\$389	\$424	N/A	\$163	\$61	\$135	\$133
SN1	24x72	\$1,258	\$1,468	\$1,678	15%	\$389	\$424	N/A	\$163	\$61	\$135	\$133
SN1	24x84	\$1,474	\$1,720	\$1,965	15%	\$389	\$424	N/A	\$163	\$61	\$135	\$133
SN1	24x96	\$1,474	\$1,720	\$1,965	15%	\$389	\$424	N/A	\$163	\$61	\$135	\$133
SN1	24x120 (1 piece)	\$1,548	\$1,806	\$2,064	CF	N/A	N/A	N/A	\$244	\$91	\$135	\$133
SN1	24x144 (1 piece)	\$1,625	\$1,896	\$2,167	CF	N/A	N/A	N/A	\$244	\$91	\$135	\$133
SN1	30x36	\$1,135	\$1,324	\$1,513	15%	\$389	N/A	N/A	\$163	\$61	\$135	\$133
SN1	30x42	\$1,199	\$1,399	\$1,599	15%	\$389	N/A	N/A	\$163	\$61	\$135	\$133
SN1	30x48	\$1,264	\$1,474	\$1,685	15%	\$389	N/A	N/A	\$163	\$61	\$135	\$133
SN1	30x60	\$1,392	\$1,625	\$1,857	15%	\$389	\$424	N/A	\$163	\$61	\$135	\$133
SN1	30x72	\$1,406	\$1,641	\$1,875	15%	\$389	\$424	N/A	\$163	\$61	\$135	\$133
SN1	30x84	\$1,779	\$2,075	\$2,372	15%	\$389	\$424	N/A	\$163	\$61	\$135	\$133
SN1	30x96	\$1,779	\$2,075	\$2,372	15%	\$389	\$424	N/A	\$163	\$61	\$135	\$133
SN1	30x120 (1 piece)	\$1,868	\$2,179	\$2,490	CF	N/A	N/A	N/A	\$244	\$91	\$135	\$133
SN1	30x144 (1 piece)	\$1,961	\$2,288	\$2,615	CF	N/A	N/A	N/A	\$244	\$91	\$135	\$133
SN1	36x42	\$1,285	\$1,499	\$1,713	15%	\$389	N/A	N/A	\$163	\$61	\$135	\$133
SN1	36x48	\$1,359	\$1,586	\$1,813	15%	\$389	N/A	N/A	\$163	\$61	\$135	\$133
SN1	36x60	\$1,509	\$1,761	\$2,012	15%	\$389	\$424	N/A	\$163	\$61	\$135	\$133
SN1	36x72	\$1,659	\$1,935	\$2,212	15%	\$389	\$424	N/A	\$163	\$61	\$135	\$133
SN1	36x84	\$1,958	\$2,285	\$2,611	15%	\$389	\$424	N/A	\$163	\$61	\$135	\$133

SENSE TABLES - (LAMINATE - WOOD EDGE)

Limited Base Finish Options - Textured Only



		Edge Choice: Wood (Red Oak & Maple)			Wood Upgrade	OPTIONS							
		W-12	W-23 W-18 W-16	W-19 W-17 W-32	Upgrade: Walnut / Mahogany / Cherry	NESTING	FOLDING	FLIP TOP	DELUXE CASTERS (BLK)	EQUALIZER GLIDES	UPGRADE FINISH (5 TABLES MIN.)	SPECIAL HEIGHT	
					ADD	ADD	ADD	ADD	ADD	ADD	ADD	ADD	
SN1	36x96	\$1,958	\$2,285	\$2,611	15%	\$389	\$424	N/A	\$163	\$61	\$135	\$133	
SN1	36x120 (1 piece)	\$2,501	\$2,918	\$3,335	15%	N/A	N/A	N/A	\$244	\$91	\$135	\$133	
SN1	36x144 (1 piece)	N/A	N/A	N/A	N/A	N/A	N/A	N/A	\$244	\$91	\$135	\$133	
RACETRACK (RAC)													
SN1	36x72	\$1,793	\$2,092	\$2,391	15%	\$389	\$313	N/A	\$163	\$61	\$135	\$133	
SN1	36x84	\$2,093	\$2,441	\$2,790	15%	\$389	\$313	N/A	\$163	\$61	\$135	\$133	
SN1	36x96	\$2,093	\$2,441	\$2,790	15%	\$389	\$313	N/A	\$163	\$61	\$135	\$133	
OVAL (OVL)													
SN1	36x60	\$1,793	\$2,092	\$2,391	15%	\$389	N/A	N/A	\$163	\$61	\$135	\$133	
SN1	36x72	\$1,793	\$2,092	\$2,391	15%	\$389	\$313	N/A	\$163	\$61	\$135	\$133	
SN1	36x84	\$2,093	\$2,441	\$2,790	15%	\$389	\$313	N/A	\$163	\$61	\$135	\$133	
SN1	36x96	\$2,093	\$2,441	\$2,790	15%	\$389	\$313	N/A	\$163	\$61	\$135	\$133	
TRAPEZOID (TRP)													
SN1	24x24x48	\$1,274	\$1,490	\$1,694	15%	\$389	N/A	N/A	\$163	\$61	\$135	\$133	
SN1	24x36x60	\$1,646	\$1,926	\$2,189	15%	\$389	N/A	N/A	\$163	\$61	\$135	\$133	
SN1	30x30x60	\$1,529	\$1,789	\$2,033	15%	\$389	N/A	N/A	\$163	\$61	\$135	\$133	
SN1	30x42x72	\$1,970	\$2,305	\$2,620	15%	\$389	N/A	N/A	\$163	\$61	\$135	\$133	
SN1	36x36x72	\$1,956	\$2,289	\$2,602	15%	\$389	N/A	N/A	\$163	\$61	\$135	\$133	
HALF ROUND (HRD)													
SN1	24x48	\$1,178	\$1,378	\$1,567	15%	\$389	N/A	N/A	\$163	\$61	\$135	\$133	
SN1	30x60	\$1,427	\$1,670	\$1,898	15%	\$389	N/A	N/A	\$163	\$61	\$135	\$133	
SN1	36x72	\$1,849	\$2,164	\$2,460	15%	\$389	N/A	N/A	\$163	\$61	\$135	\$133	
QUARTER ROUND (QRD)													
SN1	24x24	\$965	\$1,129	\$1,284	15%	N/A	N/A	N/A	\$163	\$61	\$135	\$133	
SN1	30x30	\$1,104	\$1,292	\$1,469	15%	N/A	N/A	N/A	\$163	\$61	\$135	\$133	
SN1	36x36	\$1,393	\$1,630	\$1,853	15%	N/A	N/A	N/A	\$163	\$61	\$135	\$133	
CRESCENT (CRT)													
SN1	24x24x48	\$1,284	\$1,502	\$1,707	15%	\$389	N/A	N/A	\$163	\$61	\$135	\$133	
SN1	30x30x60	\$1,666	\$1,949	\$2,215	15%	\$389	N/A	N/A	\$163	\$61	\$135	\$133	
SN1	36x36x72	\$1,956	\$2,289	\$2,602	15%	\$389	N/A	N/A	\$163	\$61	\$135	\$133	

STARFIRE



STARFIRE

Starfire Tables with cast iron pedestals offer Berco's classic styling and are ideally suited for education and dining environments.

Table Pedestals Specifications

Finishes: Available in 5 powder coat wrinkle finishes. Our unique mechanical construction enables a flawless seam when mixing column finishes with any base finish.

Glides and Casters: All tables are equipped with 1" diameter stainless steel, rubber cushioned glides with 1/2" long stem. Optional styles of glides and casters available at an up charge.

Columns: 2" diameter (14 gauge) and 3" diameter (16 gauge) columns constructed from flash controlled tubing.

Base Plate: All cast iron base plates are surface ground and machined for column recess, guaranteeing uniform height and wobble-free tables. Each casting is drilled and tapped for adjustable glides.

Spiders (Top Plates): All pedestals come standard with either a 10" or 15" cast spider, machined for column recess to insure levelness. Each spider is finished using recycled powder coat paint.

Starfire Table Options

There are several options available on Starfire including:

- Nesting
- Folding
- Flip Top
- Special Height
- Center Mount Electrical Column

STARFIRE BASE SPECIFICATIONS

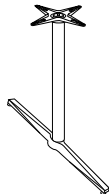
<u>End Base</u>	<u>Smart Code</u>	<u>Base Size</u>	<u>Column Diameter</u>	<u>Top Capacity</u>
	ST1-22EB	22"	2"	30"x96"
	ST1-26EB	26"	2"	36"x96"

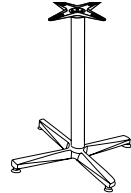
<u>Cross Base</u>	<u>Smart Code</u>	<u>Base Size</u>	<u>Column Diameter</u>	<u>Top Capacity</u>
	STX-22	22"	2"	30" SQ & RND
	STX-26	26"	2"	36" SQ & RND
	STX-32	32"	3"	42" SQ & 48" RND
	STX-42	42"	3"	48" SQ & 60" RND

STARFIRE TABLES - (LAMINATE - PVC EDGE)

Limited Base Finish Options - Textured Only



		Edge Choice: PVC & T-Mold				Laminate Upgrades		Light Weight	OPTIONS						
		T-15	L-21	P-14	PK-2	Laminate Upgrade I	Laminate Upgrade II	Light Weight (PVC only - 1" top)	NESTING	FLIP TOP	DELUXE CASTERS (BLK)	EQUALIZER GLIDES	CENTER MOUNT ELEC. COLUMN	UPGRADE FINISH (5 TABLES MIN)	SPECIAL HEIGHT
		P-10 (self)	P-12		PK-4	ADD	ADD	ADD	ADD	ADD	ADD	ADD	ADD	ADD	ADD
		L-15			L-23										
SQUARE (SQR)															
STX	24x24	\$610	\$640	\$671	\$46	\$122	\$107	N/A	\$112	\$163	\$61	\$338	\$284	\$80	
STX	30x30	\$689	\$723	\$757	\$52	\$138	\$121	N/A	\$112	\$163	\$61	\$338	\$284	\$80	
STX	36x36	\$801	\$841	\$881	\$60	\$160	\$140	N/A	\$112	\$163	\$61	\$338	\$284	\$80	
STX	42x42	\$992	\$1,042	\$1,091	\$74	\$198	\$174	N/A	\$112	\$163	\$61	N/A	\$284	\$80	
ROUND (RND)															
STX	24	\$641	\$673	\$705	\$48	\$128	\$112	N/A	\$112	\$163	\$61	\$338	\$284	\$80	
STX	30	\$716	\$752	\$788	\$54	\$143	\$125	N/A	\$112	\$163	\$61	\$338	\$284	\$80	
STX	36	\$825	\$866	\$908	\$62	\$165	\$144	N/A	\$112	\$163	\$61	\$338	\$284	\$80	
STX	42	\$1,013	\$1,063	\$1,114	\$76	\$203	\$177	N/A	\$112	\$163	\$61	\$338	\$284	\$80	
STX	48	\$1,130	\$1,186	\$1,243	\$85	\$226	\$198	N/A	\$112	\$163	\$61	N/A	\$284	\$80	
RECTANGLE (REC)															
ST1	24x60	\$976	\$1,025	\$1,073	\$73	\$195	\$171	\$389	N/A	\$163	\$61	N/A	\$284	\$133	
ST1	24x72	\$1,048	\$1,100	\$1,153	\$79	\$210	\$183	\$389	N/A	\$163	\$61	N/A	\$284	\$133	
ST1	24x96	\$1,192	\$1,251	\$1,311	\$89	\$238	\$209	\$389	N/A	\$163	\$61	N/A	\$284	\$133	
STX	30x42 (2431X)	\$755	\$793	\$831	\$57	\$151	\$132	N/A	N/A	\$163	\$61	N/A	\$284	\$133	
STX	30x48 (2431X)	\$788	\$827	\$867	\$59	\$158	\$138	N/A	N/A	\$163	\$61	N/A	\$284	\$133	
ST1	30x60	\$1,054	\$1,106	\$1,159	\$79	\$211	\$184	\$389	N/A	\$163	\$61	N/A	\$284	\$133	
ST1	30x72	\$1,063	\$1,116	\$1,169	\$80	\$213	\$186	\$389	N/A	\$163	\$61	N/A	\$284	\$133	
ST1	30x96	\$1,311	\$1,377	\$1,442	\$98	\$262	\$229	\$389	N/A	\$163	\$61	N/A	\$284	\$133	
ST1	36x60	\$1,153	\$1,211	\$1,268	\$86	\$231	\$202	\$389	N/A	\$163	\$61	N/A	\$284	\$133	
ST1	36x72	\$1,253	\$1,315	\$1,378	\$94	\$251	\$219	\$389	N/A	\$163	\$61	N/A	\$284	\$133	
ST1	36x96	\$1,452	\$1,525	\$1,598	\$109	\$290	\$254	\$389	N/A	\$163	\$61	N/A	\$284	\$133	

STARFIRE TABLES - (LAMINATE - WOOD EDGE)

Limited Base Finish Options - Textured Only



		Edge Choice: Wood (Red Oak & Maple)			Wood Upgrade	OPTIONS							
		W-12	W-23	W-19	Upgrade: Walnut / Mahogany / Cherry	NESTING	FLIP TOP	DELUXE CASTERS (BLK)	EQUALIZER GLIDES	CENTER MOUNT ELEC. COLUMN	UPGRADE FINISH (5 TABLES MIN)	SPECIAL HEIGHT	
			W-18	W-17		ADD	ADD	ADD	ADD	ADD	ADD	ADD	
			W-16	W-32									
SQUARE (SQR)													
STX	24x24	\$915	\$1,067	\$1,219	15%	N/A	\$112	\$163	\$61	\$338	\$284	\$80	
STX	30x30	\$1,033	\$1,205	\$1,377	15%	N/A	\$112	\$163	\$61	\$338	\$284	\$80	
STX	36x36	\$1,202	\$1,402	\$1,602	15%	N/A	\$112	\$163	\$61	\$338	\$284	\$80	
STX	42x42	\$1,860	\$2,232	\$2,480	15%	N/A	\$112	\$163	\$61	N/A	\$284	\$80	
ROUND (RND)													
STX	24	\$961	\$1,121	\$1,281	15%	N/A	\$112	\$163	\$61	\$338	\$284	\$80	
STX	30	\$1,074	\$1,253	\$1,432	15%	N/A	\$112	\$163	\$61	\$338	\$284	\$80	
STX	36	\$1,238	\$1,444	\$1,650	15%	N/A	\$112	\$163	\$61	\$338	\$284	\$80	
STX	42	\$1,899	\$2,279	\$2,532	15%	N/A	\$112	\$163	\$61	\$338	\$284	\$80	
STX	48	\$2,119	\$2,542	\$2,825	15%	N/A	\$112	\$163	\$61	N/A	\$284	\$80	
RECTANGLE (REC)													
ST1	24x60	\$1,464	\$1,708	\$1,952	15%	\$389	N/A	\$163	\$61	N/A	\$284	\$133	
ST1	24x72	\$1,572	\$1,834	\$2,096	15%	\$389	N/A	\$163	\$61	N/A	\$284	\$133	
ST1	24x96	\$1,787	\$2,085	\$2,383	15%	\$389	N/A	\$163	\$61	N/A	\$284	\$133	
STX	30x42 (2431X)	\$1,119	\$1,309	\$1,488	15%	N/A	N/A	\$163	\$61	N/A	\$284	\$133	
STX	30x48 (2431X)	\$1,185	\$1,386	\$1,576	15%	N/A	N/A	\$163	\$61	N/A	\$284	\$133	
ST1	30x60	\$1,581	\$1,844	\$2,107	15%	\$389	N/A	\$163	\$61	N/A	\$284	\$133	
ST1	30x72	\$1,594	\$1,860	\$2,126	15%	\$389	N/A	\$163	\$61	N/A	\$284	\$133	
ST1	30x96	\$1,967	\$2,295	\$2,623	15%	\$389	N/A	\$163	\$61	N/A	\$284	\$133	
ST1	36x60	\$1,729	\$2,018	\$2,306	15%	\$389	N/A	\$163	\$61	N/A	\$284	\$133	
ST1	36x72	\$1,879	\$2,192	\$2,505	15%	\$389	N/A	\$163	\$61	N/A	\$284	\$133	
ST1	36x96	\$2,179	\$2,542	\$2,905	15%	\$389	N/A	\$163	\$61	N/A	\$284	\$133	

TELESTO



TELESTO

Our Telesto Table System is a complete family of tables solely developed by Berco's designers and engineers with the goal of aesthetics, quality and value contributing to the finished product.

Table Pedestal Specifications

Finishes: Offered in Standard Textured powder coat finishes. Our unique mechanical construction creates a flawless seam when matching column finishes with any base finish.

Glides and Casters: All tables are equipped with 2" diameter glides with brushed stainless steel cover over black plastic, 10mm threaded with 15mm long stem. The glide is suitable for carpet as well hard floors. Our twin wheel locking casters are offered as an option.

Pedestal Specifications

Fixed end base pedestals feature an aluminum column and spider support with die-cast aluminum base and are attached with (2) 3/8" -18 threaded steel rod and flange nut at 35 ft/lbs torque.

Folding mechanism

Our patented spring loaded folding mechanism is fully riveted to a steel mounting plate. Vinyl bumpers are integrated into the mechanism allowing for a non-marring, 3-1/2" stacking height. Equipped with molded release handle. Integral catch holds leg in folded position. Folding legs feature the same column housing as Telesto stationary tables attached to Berco's patented mechanism.

Telesto Table Options

There are several options available on Telesto including:

- Nesting
- Folding
- Special Height

TELESTO BASE SPECIFICATIONS

<u>End Base</u>	<u>Smart Code</u>	<u>Base Size</u>	<u>Column Size</u>	<u>Top Capacity</u>
	TLS-20EB	20"	2"x5.25"	24"x96"
	TLS-26EB	26"	2"x5.25"	36"x96"



NOTE: TEXTURED PAINT ONLY

TELESTO TABLES (LAMINATE - PVC EDGE)

	Edge Choice: PVC or T-Mold				Laminate Upgrades		Light Weight	OPTIONS			
	T-15	L-21	P-14	PK-2	Laminate Upgrade I	Laminate Upgrade II	Light Weight (PVC only - 1" top)	NESTING		DELUXE CASTERS (BLK)	SPECIAL HEIGHT
	P-10 (self)	P-12		PK-4	ADD	ADD	ADD	ADD		ADD	ADD
RECTANGLE (REC)											
TLS 24x48	\$1,064	\$1,117	\$1,170	\$80	\$213	\$186	\$389			\$163	\$133
TLS 24x60	\$1,136	\$1,193	\$1,249	\$85	\$227	\$199	\$389			\$163	\$133
TLS 24x72	\$1,208	\$1,268	\$1,328	\$91	\$242	\$211	\$389			\$163	\$133
TLS 24x84	\$1,280	\$1,344	\$1,408	\$96	\$256	\$224	\$389			\$163	\$133
TLS 24x96	\$1,351	\$1,419	\$1,487	\$101	\$270	\$237	\$389			\$163	\$133
TLS 30x48	\$1,159	\$1,216	\$1,274	\$87	\$232	\$203	\$389			\$163	\$133
TLS 30x60	\$1,244	\$1,307	\$1,369	\$93	\$249	\$218	\$389			\$163	\$133
TLS 30x72	\$1,254	\$1,316	\$1,379	\$94	\$251	\$219	\$389			\$163	\$133
TLS 30x84	\$1,416	\$1,487	\$1,558	\$106	\$283	\$248	\$389			\$163	\$133
TLS 30x96	\$1,502	\$1,577	\$1,652	\$113	\$300	\$263	\$389			\$163	\$133
TLS 36x48	\$1,222	\$1,284	\$1,345	\$92	\$244	\$214	\$389			\$163	\$133
TLS 36x60	\$1,322	\$1,388	\$1,454	\$99	\$264	\$231	\$389			\$163	\$133
TLS 36x72	\$1,422	\$1,493	\$1,564	\$107	\$284	\$249	\$389			\$163	\$133
TLS 36x84	\$1,522	\$1,598	\$1,674	\$114	\$304	\$266	\$389			\$163	\$133
TLS 36x96	\$1,622	\$1,703	\$1,784	\$122	\$324	\$284	\$389			\$163	\$133
RACETRACK (RAC)											
TLS 36x72	\$1,511	\$1,587	\$1,663	\$113	\$302	\$264	\$389			\$163	\$133
TLS 36x84	\$1,611	\$1,692	\$1,772	\$121	\$322	\$282	\$389			\$163	\$133
TLS 36x96	\$1,711	\$1,797	\$1,882	\$128	\$342	\$299	\$389			\$163	\$133
OVAL (OVL)											
TLS 36x60	\$1,412	\$1,482	\$1,553	\$106	\$282	\$247	\$389			\$163	\$133
TLS 36x72	\$1,511	\$1,587	\$1,663	\$113	\$302	\$264	\$389			\$163	\$133
TLS 36x84	\$1,611	\$1,692	\$1,772	\$121	\$322	\$282	\$389			\$163	\$133
TLS 36x96	\$1,711	\$1,797	\$1,882	\$128	\$342	\$299	\$389			\$163	\$133
TRAPEZOID (TRP)											
TLS 24x24x48	\$1,153	\$1,211	\$1,269	\$86	\$231	\$202	\$389			\$163	\$133
TLS 24x36x60	\$1,381	\$1,450	\$1,519	\$104	\$276	\$242	\$389			\$163	\$133
TLS 30x30x60	\$1,303	\$1,368	\$1,433	\$98	\$261	\$228	\$389			\$163	\$133
TLS 30x42x72	\$1,572	\$1,651	\$1,730	\$118	\$314	\$275	\$389			\$163	\$133
TLS 36x36x72	\$1,511	\$1,587	\$1,663	\$113	\$302	\$264	\$389			\$163	\$133
HALF ROUND (HRD)											
TLS 24x48	\$1,095	\$1,149	\$1,204	\$82	\$219	\$192	\$389			\$163	\$133
TLS 30x60	\$1,241	\$1,303	\$1,365	\$93	\$248	\$217	\$389			\$163	\$133
TLS 36x72	\$1,415	\$1,486	\$1,557	\$106	\$283	\$248	\$389			\$163	\$133
QUARTER ROUND (QRD)											
TLS 30x30	\$1,044	\$1,096	\$1,148	\$78	\$209	\$183	N/A			\$163	\$133
TLS 36x36	\$1,136	\$1,193	\$1,250	\$85	\$227	\$199	N/A			\$163	\$133
CRESCENT (CRT)											
TLS 24x24x48	\$1,153	\$1,211	\$1,269	\$86	\$231	\$202	\$389			\$163	\$133
TLS 30x30x60	\$1,334	\$1,400	\$1,467	\$100	\$267	\$233	\$389			\$163	\$133
TLS 36x36x72	\$1,511	\$1,587	\$1,663	\$113	\$302	\$264	\$389			\$163	\$133



NOTE: TEXTURED PAINT ONLY

TELESTO TABLES (LAMINATE - WOOD EDGE)

	Edge Choice: Wood (Red Oak & Maple)			Wood Upgrade	OPTIONS					
	W-12	W-23	W-19	Upgrade: Walnut / Mahogany / Cherry	NESTING			DELUXE CASTERS (BLK)	SPECIAL HEIGHT	
				ADD	ADD			ADD	ADD	
RECTANGLE (REC)										
TLS 24x48	\$1,596	\$1,862	\$2,128	15%	\$389			\$163	\$133	
TLS 24x60	\$1,704	\$1,988	\$2,271	15%	\$389			\$163	\$133	
TLS 24x72	\$1,811	\$2,113	\$2,415	15%	\$389			\$163	\$133	
TLS 24x84	\$2,027	\$2,365	\$2,703	15%	\$389			\$163	\$133	
TLS 24x96	\$2,027	\$2,365	\$2,703	15%	\$389			\$163	\$133	
TLS 30x48	\$1,738	\$2,027	\$2,317	15%	\$389			\$163	\$133	
TLS 30x60	\$1,867	\$2,178	\$2,489	15%	\$389			\$163	\$133	
TLS 30x72	\$1,880	\$2,194	\$2,507	15%	\$389			\$163	\$133	
TLS 30x84	\$2,253	\$2,629	\$3,004	15%	\$389			\$163	\$133	
TLS 30x96	\$2,253	\$2,629	\$3,004	15%	\$389			\$163	\$133	
TLS 36x48	\$1,834	\$2,139	\$2,445	15%	\$389			\$163	\$133	
TLS 36x60	\$1,983	\$2,314	\$2,644	15%	\$389			\$163	\$133	
TLS 36x72	\$2,133	\$2,489	\$2,844	15%	\$389			\$163	\$133	
TLS 36x84	\$2,433	\$2,838	\$3,243	15%	\$389			\$163	\$133	
TLS 36x96	\$2,433	\$2,838	\$3,243	15%	\$389			\$163	\$133	
RACETRACK (RAC)										
TLS 36x72	\$2,267	\$2,645	\$3,023	15%	\$389			\$163	\$133	
TLS 36x84	\$2,567	\$2,994	\$3,422	15%	\$389			\$163	\$133	
TLS 36x96	\$2,567	\$2,994	\$3,422	15%	\$389			\$163	\$133	
OVAL (OVL)										
TLS 36x60	\$2,267	\$2,645	\$3,023	15%	\$389			\$163	\$133	
TLS 36x72	\$2,267	\$2,645	\$3,023	15%	\$389			\$163	\$133	
TLS 36x84	\$2,567	\$2,994	\$3,422	15%	\$389			\$163	\$133	
TLS 36x96	\$2,567	\$2,994	\$3,422	15%	\$389			\$163	\$133	
TRAPEZOID (TRP)										
TLS 24x24x48	\$1,852	\$2,167	\$2,463	15%	\$389			\$163	\$133	
TLS 24x36x60	\$2,218	\$2,595	\$2,949	15%	\$389			\$163	\$133	
TLS 30x30x60	\$2,093	\$2,448	\$2,783	15%	\$389			\$163	\$133	
TLS 30x42x72	\$2,525	\$2,955	\$3,359	15%	\$389			\$163	\$133	
TLS 36x36x72	\$2,427	\$2,840	\$3,229	15%	\$389			\$163	\$133	
HALF ROUND (HRD)										
TLS 24x48	\$1,758	\$2,057	\$2,338	15%	\$389			\$163	\$133	
TLS 30x60	\$1,993	\$2,332	\$2,651	15%	\$389			\$163	\$133	
TLS 36x72	\$2,273	\$2,659	\$3,023	15%	\$389			\$163	\$133	
QUARTER ROUND (QRD)										
TLS 30x30	\$1,676	\$1,961	\$2,229	15%	N/A			\$163	\$133	
TLS 36x36	\$1,825	\$2,135	\$2,427	15%	N/A			\$163	\$133	
CRESCENT (CRT)										
TLS 24x24x48	\$1,852	\$2,167	\$2,463	15%	\$389			\$163	\$133	
TLS 30x30x60	\$2,142	\$2,506	\$2,849	15%	\$389			\$163	\$133	
TLS 36x36x72	\$2,427	\$2,840	\$3,229	15%	\$389			\$163	\$133	



NOTE: TEXTURED PAINT ONLY

TELESTO TABLES (VENEER)

	Edge Choice: Wood (Red Oak & Maple)			Wood Upgrade	OPTIONS			
	V-12	V-23	V-19	Upgrade: Walnut / Mahogany / Cherry	NESTING		DELUXE CASTERS (BLK)	SPECIAL HEIGHT
				ADD	ADD		ADD	ADD
RECTANGLE (REC)								
TLS 24x48	\$1,751	\$1,926	\$2,013	15%	\$389		\$163	\$133
TLS 24x60	\$2,029	\$2,231	\$2,333	15%	\$389		\$163	\$133
TLS 24x72	\$2,314	\$2,545	\$2,661	15%	\$389		\$163	\$133
TLS 24x84	\$2,884	\$3,173	\$3,317	15%	\$389		\$163	\$133
TLS 24x96	\$2,884	\$3,173	\$3,317	15%	\$389		\$163	\$133
TLS 30x48	\$2,038	\$2,241	\$2,343	15%	\$389		\$163	\$133
TLS 30x60	\$2,389	\$2,627	\$2,747	15%	\$389		\$163	\$133
TLS 30x72	\$2,740	\$3,014	\$3,150	15%	\$389		\$163	\$133
TLS 30x84	\$3,442	\$3,786	\$3,958	15%	\$389		\$163	\$133
TLS 30x96	\$3,442	\$3,786	\$3,958	15%	\$389		\$163	\$133
TLS 36x48	\$2,323	\$2,555	\$2,671	15%	\$389		\$163	\$133
TLS 36x60	\$2,740	\$3,014	\$3,150	15%	\$389		\$163	\$133
TLS 36x72	\$3,156	\$3,472	\$3,630	15%	\$389		\$163	\$133
TLS 36x84	\$3,997	\$4,397	\$4,597	15%	\$389		\$163	\$133
TLS 36x96	\$3,997	\$4,397	\$4,597	15%	\$389		\$163	\$133
RACETRACK (RAC)								
TLS 36x72	\$3,698	\$4,067	\$4,252	15%	\$389		\$163	\$133
TLS 36x84	\$4,531	\$4,984	\$5,211	15%	\$389		\$163	\$133
TLS 36x96	\$4,531	\$4,984	\$5,211	15%	\$389		\$163	\$133
OVAL (OVL)								
TLS 36x60	\$3,975	\$4,373	\$4,572	15%	\$389		\$163	\$133
TLS 36x72	\$3,975	\$4,373	\$4,572	15%	\$389		\$163	\$133
TLS 36x84	\$5,087	\$5,596	\$5,850	15%	\$389		\$163	\$133
TLS 36x96	\$5,087	\$5,596	\$5,850	15%	\$389		\$163	\$133
TRAPEZOID (TRP)								
TLS 24x24x48	\$1,852	\$2,037	\$2,130	15%	\$389		\$163	\$133
TLS 24x36x60	\$2,218	\$2,439	\$2,550	15%	\$389		\$163	\$133
TLS 30x30x60	\$2,093	\$2,302	\$2,407	15%	\$389		\$163	\$133
TLS 30x42x72	\$2,525	\$2,778	\$2,904	15%	\$389		\$163	\$133
TLS 36x36x72	\$2,427	\$2,670	\$2,792	15%	\$389		\$163	\$133
HALF ROUND (HRD)								
TLS 24x48	\$1,758	\$1,934	\$2,022	15%	\$389		\$163	\$133
TLS 30x60	\$1,993	\$2,192	\$2,292	15%	\$389		\$163	\$133
TLS 36x72	\$2,273	\$2,500	\$2,614	15%	\$389		\$163	\$133
QUARTER ROUND (QRD)								
TLS 30x30	\$1,676	\$1,844	\$1,927	15%	N/A		\$163	\$133
TLS 36x36	\$1,825	\$2,008	\$2,099	15%	N/A		\$163	\$133
CRESCENT (CRT)								
TLS 24x24x48	\$1,852	\$2,037	\$2,130	15%	\$389		\$163	\$133
TLS 30x30x60	\$2,142	\$2,356	\$2,463	15%	\$389		\$163	\$133
TLS 36x36x72	\$2,427	\$2,670	\$2,792	15%	\$389		\$163	\$133

TITAN



TITAN

Titan Tables are manufactured with Berco's goal of quality and value and are ideally suited for use in a myriad of settings including corporate training rooms, cafeterias, educational settings and healthcare environments. Your choice of options make our Titan tables adapt to your specific requirements.

Table Pedestal Specifications

Finishes: Available in 40+ standard powder coat finishes. Chrome plated finishes are offered at an additional charge. Our unique mechanical construction enables a flawless seam when mixing column finishes with any base finish. Custom finishes available. Please contact Customer Service for quotation.

Glides and Casters: All tables are equipped with 2" diameter glides with brushed stainless steel cover over black plastic foot. The stem is M10 and 15mm long. The glide is suitable for carpet, as well as hard floors. Our high quality twin wheel locking casters are offered as an option.

Titan Folding Table Leg Specifications

Our patented spring loaded folding mechanism is fully riveted to a steel mounting plate. Vinyl bumpers are integrated into the mechanism allowing for a non-marring, 3-1/2" stacking height. Equipped with a molded release handle and an integral catch holds leg in folded position.

Titan Table Options

There are several options available on Titan including:

- Folding
- Special Height

TITAN

TITAN BASE SPECIFICATIONS

Pedestal



Smart Code

- TS1-2
- TS1-3
- TS1-4

Base Size

- N/A
- N/A
- N/A

Column Diameter

- 2"
- 3"
- 4"

Top Capacity

30" Minimum Width
Distance Between
Legs Not To Exceed
48"

Permanent Mount

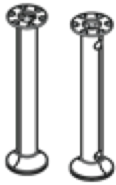

Smart Code

- TS1-PMB
- TS1-PMBE

Base Size

- N/A
- N/A

Column Diameter

- 3"
- 3"

Top Capacity

Consult Factory



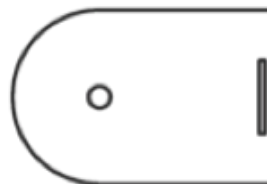
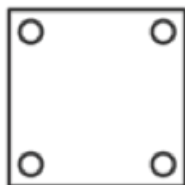
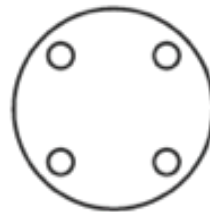
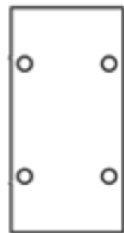



TITAN DESIGN OPTIONS





TITAN TABLES - (LAMINATE - PVC EDGE)											
Edge Choice: PVC & T-Mold				Laminate Upgrades		Light Weight	OPTIONS				
				Laminate Upgrade I	Laminate Upgrade II	Light Weight (PVC only - 1" top)	FOLDING	POWDERCOAT UPGRADE	CHROME	DELUXE CASTERS (BLK)	SPECIAL HEIGHT
				ADD	ADD	ADD	ADD	ADD	ADD	ADD	ADD
SQUARE (SQR)											
TS1 42x42	\$1,340	\$1,407	\$1,474	\$100	\$268	\$234	\$848	\$134	\$339	\$163	\$133
TS1 48x48	\$1,454	\$1,527	\$1,600	\$109	\$291	\$255	\$848	\$134	\$339	\$163	\$133
TS1 60x60	\$1,724	\$1,810	\$1,896	\$129	\$345	N/A	N/A	\$134	\$339	\$163	\$133
ROUND (RND)											
TS1 36	\$1,261	\$1,324	\$1,387	\$95	\$252	\$221	N/A	\$134	\$339	\$163	\$133
TS1 42	\$1,359	\$1,427	\$1,495	\$102	\$272	\$238	N/A	\$134	\$339	\$163	\$133
TS1 48	\$1,471	\$1,544	\$1,618	\$110	\$294	\$257	\$848	\$134	\$339	\$163	\$133
TS1 60 (light weight std. Folding)	\$1,733	\$1,820	\$1,907	\$130	\$347	\$303	\$848	\$134	\$339	\$163	\$133
TS1 72 (light weight std. - 2 piece)	\$2,960	\$3,109	\$3,257	\$222	\$592	Incl.	\$848	\$134	\$339	\$163	\$133
RECTANGLE (REC)											
TS1 30x60	\$1,326	\$1,392	\$1,458	\$99	\$265	\$232	\$848	\$134	\$339	\$163	\$133
TS1 30x72	\$1,334	\$1,401	\$1,468	\$100	\$267	\$233	\$848	\$134	\$339	\$163	\$133
TS1 30x84	\$1,517	\$1,593	\$1,669	\$114	\$303	\$266	\$848	\$134	\$339	\$163	\$133
TS1 30x96	\$1,599	\$1,679	\$1,759	\$120	\$320	\$280	\$848	\$134	\$339	\$163	\$133
TS1 36x60	\$1,428	\$1,499	\$1,571	\$107	\$286	\$250	\$848	\$134	\$339	\$163	\$133
TS1 36x72	\$1,523	\$1,599	\$1,675	\$114	\$305	\$266	\$848	\$134	\$339	\$163	\$133
TS1 36x84	\$1,618	\$1,699	\$1,779	\$121	\$324	\$283	\$848	\$134	\$339	\$163	\$133
TS1 36x96	\$1,712	\$1,798	\$1,884	\$128	\$342	\$300	\$848	\$134	\$339	\$163	\$133
TS1 42x84	\$1,718	\$1,804	\$1,890	\$129	\$344	\$301	\$848	\$134	\$339	\$163	\$133
TS1 42x96	\$1,826	\$1,918	\$2,009	\$137	\$365	\$320	\$848	\$134	\$339	\$163	\$133
TS1 48x84	\$1,819	\$1,909	\$2,000	\$136	\$364	\$318	\$848	\$134	\$339	\$163	\$133
TS1 48x96	\$1,940	\$2,037	\$2,134	\$145	\$388	\$339	\$848	\$134	\$339	\$163	\$133
RACETRACK (RAC)											
TS1 30x60	\$1,439	\$1,511	\$1,583	\$108	\$288	\$252	\$848	\$134	\$339	\$163	\$133
TS1 36x72	\$1,608	\$1,688	\$1,769	\$121	\$322	\$281	\$848	\$134	\$339	\$163	\$133
TS1 36x84	\$1,703	\$1,788	\$1,873	\$128	\$341	\$298	\$848	\$134	\$339	\$163	\$133
TS1 36x96	\$1,797	\$1,887	\$1,977	\$135	\$359	\$315	\$848	\$134	\$339	\$163	\$133
TS1 42x84	\$1,803	\$1,893	\$1,983	\$135	\$361	\$316	\$848	\$134	\$339	\$163	\$133
TS1 42x96	\$1,911	\$2,007	\$2,102	\$143	\$382	\$334	\$848	\$134	\$339	\$163	\$133
TS1 48x96	\$2,025	\$2,126	\$2,227	\$152	\$405	\$354	\$848	\$134	\$339	\$163	\$133
HALF ROUND (HRD)											
TS1 24x48	\$1,046	\$1,098	\$1,151	\$78	\$209	\$183	N/A	\$134	\$339	\$163	\$133
TS1 30x60	\$1,185	\$1,244	\$1,303	\$89	\$237	\$207	N/A	\$134	\$339	\$163	\$133
TS1 36x72	\$1,350	\$1,418	\$1,485	\$101	\$270	\$236	N/A	\$134	\$339	\$163	\$133



TITAN TABLES - (LAMINATE - WOOD EDGE)										
Edge Choice: Wood (Red Oak & Maple)				Wood Upgrad	OPTIONS					
 W-12	 W-23	 W-19	 W-18	 W-17	Upgrade: Walnut / Mahogany / Cherry	FOLDING	POWDERCOAT UPGRADE	CHROME	DELUXE CASTERS (BLK)	SPECIAL HEIGHT
 W-16	 W-32					ADD	ADD	ADD	ADD	ADD
SQUARE (SQR)										
TS1 42x42	\$2,512	\$3,014	\$3,349	15%	\$848	\$134	\$339	\$163	\$133	
TS1 48x48	\$2,727	\$3,273	\$3,636	15%	\$848	\$134	\$339	\$163	\$133	
TS1 60x60	\$3,232	\$3,878	\$4,309	15%	N/A	\$134	\$339	\$163	\$133	
ROUND (RND)										
TS1 36	\$1,892	\$2,207	\$2,522	15%	N/A	\$134	\$339	\$163	\$133	
TS1 42	\$2,549	\$3,058	\$3,398	15%	N/A	\$134	\$339	\$163	\$133	
TS1 48	\$2,757	\$3,309	\$3,677	15%	\$848	\$134	\$339	\$163	\$133	
TS1 60 (light weight std. Folding)	\$3,250	\$3,900	\$4,333	15%	\$848	\$134	\$339	\$163	\$133	
TS1 72 (light weight std. - 2 piece)	\$5,551	\$6,661	\$7,401	15%	\$848	\$134	\$339	\$163	\$133	
RECTANGLE (REC)										
TS1 30x60	\$1,988	\$2,320	\$2,651	15%	\$848	\$134	\$339	\$163	\$133	
TS1 30x72	\$2,001	\$2,335	\$2,668	15%	\$848	\$134	\$339	\$163	\$133	
TS1 30x84	\$2,398	\$2,798	\$3,198	15%	\$848	\$134	\$339	\$163	\$133	
TS1 30x96	\$2,398	\$2,798	\$3,198	15%	\$848	\$134	\$339	\$163	\$133	
TS1 36x60	\$2,142	\$2,499	\$2,856	15%	\$848	\$134	\$339	\$163	\$133	
TS1 36x72	\$2,284	\$2,665	\$3,046	15%	\$848	\$134	\$339	\$163	\$133	
TS1 36x84	\$2,569	\$2,997	\$3,425	15%	\$848	\$134	\$339	\$163	\$133	
TS1 36x96	\$2,569	\$2,997	\$3,425	15%	\$848	\$134	\$339	\$163	\$133	
TS1 42x84	\$2,826	\$3,297	\$3,767	5%	\$848	\$134	\$339	\$163	\$133	
TS1 42x96	\$3,391	\$3,956	\$4,521	15%	\$848	\$134	\$339	\$163	\$133	
TS1 48x84	\$3,391	\$3,956	\$4,521	15%	\$848	\$134	\$339	\$163	\$133	
TS1 48x96	\$3,637	\$4,365	\$4,850	15%	\$848	\$134	\$339	\$163	\$133	
RACETRACK (RAC)										
TS1 30x60	\$2,412	\$2,814	\$3,215	15%	\$848	\$134	\$339	\$163	\$133	
TS1 36x72	\$2,412	\$2,814	\$3,215	15%	\$848	\$134	\$339	\$163	\$133	
TS1 36x84	\$2,696	\$3,145	\$3,595	15%	\$848	\$134	\$339	\$163	\$133	
TS1 36x96	\$2,696	\$3,145	\$3,595	15%	\$848	\$134	\$339	\$163	\$133	
TS1 42x84	\$3,235	\$3,775	\$4,314	15%	\$848	\$134	\$339	\$163	\$133	
TS1 42x96	\$3,235	\$3,775	\$4,314	15%	\$848	\$134	\$339	\$163	\$133	
TS1 48x96	\$3,797	\$4,556	\$5,062	15%	\$848	\$134	\$339	\$163	\$133	
HALF ROUND (HRD)										
TS1 24x48	\$1,753	\$2,051	\$2,331	15%	N/A	\$134	\$339	\$163	\$133	
TS1 30x60	\$1,986	\$2,323	\$2,641	15%	N/A	\$134	\$339	\$163	\$133	
TS1 36x72	\$2,263	\$2,648	\$3,010	15%	N/A	\$134	\$339	\$163	\$133	



TITAN TABLES - (VENEER)								
Edge Choice: Wood (Red Oak & Maple)				Wood Upgrade	OPTIONS			
V-12	V-23	V-19	Upgrade: Walnut / Mahogany / Cherry	POWDERCOAT UPGRADE	CHROME	DELUXE CASTERS (BLK)	SPECIAL HEIGHT	
	V-18	V-17						
	V-16	V-32						
SQUARE (SQR)								
TS1 42x42	\$3,039	\$3,343	\$3,495	15%	\$134	\$339	\$163	\$133
TS1 48x48	\$3,365	\$3,702	\$3,870	15%	\$134	\$339	\$163	\$133
TS1 60x60	\$4,317	\$4,749	\$4,965	15%	\$134	\$339	\$163	\$133
ROUND (RND)								
TS1 36	\$2,328	\$2,561	\$2,677	15%	\$134	\$339	\$163	\$133
TS1 42	\$2,877	\$3,164	\$3,308	15%	\$134	\$339	\$163	\$133
TS1 48	\$3,506	\$3,856	\$4,031	15%	\$134	\$339	\$163	\$133
TS1 60 (light weight std. Folding)	\$5,012	\$5,513	\$5,764	15%	\$134	\$339	\$163	\$133
TS1 72 (light weight std. - 2 piece)	\$7,184	\$7,902	\$8,262	15%	\$134	\$339	\$163	\$133
RECTANGLE (REC)								
TS1 30x60	\$2,569	\$2,826	\$2,955	15%	\$134	\$339	\$163	\$133
TS1 30x72	\$2,920	\$3,213	\$3,359	15%	\$134	\$339	\$163	\$133
TS1 30x84	\$3,623	\$3,985	\$4,166	15%	\$134	\$339	\$163	\$133
TS1 30x96	\$3,623	\$3,985	\$4,166	15%	\$134	\$339	\$163	\$133
TS1 36x60	\$2,920	\$3,213	\$3,359	15%	\$134	\$339	\$163	\$133
TS1 36x72	\$3,337	\$3,671	\$3,838	15%	\$134	\$339	\$163	\$133
TS1 36x84	\$4,178	\$4,596	\$4,805	15%	\$134	\$339	\$163	\$133
TS1 36x96	\$4,178	\$4,596	\$4,805	15%	\$134	\$339	\$163	\$133
TS1 42x84	\$4,596	\$5,056	\$5,286	15%	\$134	\$339	\$163	\$133
TS1 42x96	\$5,515	\$6,067	\$6,343	15%	\$134	\$339	\$163	\$133
TS1 48x84	\$5,515	\$6,067	\$6,343	15%	\$134	\$339	\$163	\$133
TS1 48x96	\$5,791	\$6,370	\$6,660	15%	\$134	\$339	\$163	\$133
RACETRACK (RAC)								
TS1 30x60	\$3,878	\$4,266	\$4,460	15%	\$134	\$339	\$163	\$133
TS1 36x72	\$3,878	\$4,266	\$4,460	15%	\$134	\$339	\$163	\$133
TS1 36x84	\$4,712	\$5,183	\$5,419	15%	\$134	\$339	\$163	\$133
TS1 36x96	\$4,712	\$5,183	\$5,419	15%	\$134	\$339	\$163	\$133
TS1 42x84	\$5,655	\$6,220	\$6,503	15%	\$134	\$339	\$163	\$133
TS1 42x96	\$5,655	\$6,220	\$6,503	15%	\$134	\$339	\$163	\$133
TS1 48x96	\$5,831	\$6,414	\$6,706	15%	\$134	\$339	\$163	\$133
HALF ROUND (HRD)								
TS1 24x48	\$1,753	\$1,928	\$2,016	15%	\$134	\$339	\$163	\$133
TS1 30x60	\$1,986	\$2,184	\$2,284	15%	\$134	\$339	\$163	\$133
TS1 36x72	\$2,263	\$2,490	\$2,603	15%	\$134	\$339	\$163	\$133

VORTEX



VORTEX

A powerful swirl of beauty and grace come together in the trumpet-shaped Vortex. Perfect for dining facilities or meeting rooms, Vortex adds a timeless, elegant look to your space. Vortex tables bases are made of spun steel with a base weight for added stability.

Pedestal Specifications:

Finishes: Available in 40+ standard powder coat finishes. Chrome plated finishes are offered at an additional charge. Our unique mechanical construction enables a flawless seam when mixing column finishes with any base finish. Custom finishes available. Please contact Customer Service for quotation.

Glides and Casters: Not available on 18" and 24" base sizes. On 30" bases glides are included. Casters NOT available on any size base.

Pedestal Specifications

Trumpet-shaped base features 14 gauge (.083) spun steel with a specially designed weight for maximum stability. 2" columns are 14 gauge and 3" columns are 16 gauge. All columns are rolled steel tubing square cut to insure levelness. Cast iron spiders are machined for column recess and bolted with 1/2"-13 steel threaded rod.

Vortex Table Options

There are several options available on Vortex including:

- Flip Top
- Special Height

VORTEX BASE SPECIFICATIONS

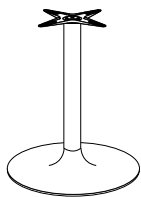

<u>Smart Code</u>	<u>Base Size</u>	<u>Column Diameter</u>	<u>Top Capacity</u>
VOX-18X	18"	2"	30" SQ & RND
VOX-24X	24"	3"	36" SQ & 48" RND
VOX-30X	30"	3"	42" SQ & 60" RND

VORTEX TABLES - (LAMINATE - PVC EDGE)



	Edge Choice: PVC or T-Mold				Laminate Upgrades		Light Weight	OPTIONS			
	T-15 P-10 (self) L-15	L-21 P-12	P-14	PK-2 PK-4 L-23	Laminate Upgrade I	Laminate Upgrade II	Light Weight (PVC only - 1" top)	FLIP-TOP	POWDERCOAT UPGRADE	CHROME	SPECIAL HEIGHT
					ADD	ADD	ADD	ADD	ADD	ADD	ADD
SQUARE (SQR)											
VOX 24x24 - no glides	\$874		\$918	\$962	\$66	\$175	\$153	\$112	\$134	\$271	\$80
VOX 30x30 - no glides	\$953		\$1,001	\$1,048	\$71	\$191	\$167	\$112	\$134	\$271	\$80
VOX 36x36 - no glides	\$1,219		\$1,280	\$1,340	\$91	\$244	\$213	\$112	\$134	\$271	\$80
VOX 42x42 - with glides	\$1,674		\$1,758	\$1,842	\$126	\$335	\$293	\$112	\$134	\$271	\$80
ROUND (RND)											
VOX 24 - no glides	\$905		\$950	\$995	\$68	\$181	\$158	\$112	\$134	\$271	\$80
VOX 30 - no glides	\$980		\$1,029	\$1,078	\$74	\$196	\$172	\$112	\$134	\$271	\$80
VOX 36 - no glides	\$1,243		\$1,305	\$1,367	\$93	\$249	\$217	\$112	\$134	\$271	\$80
VOX 42 - no glides	\$1,346		\$1,413	\$1,481	\$101	\$269	\$236	\$112	\$134	\$271	\$80
VOX 48 - no glides	\$1,463		\$1,536	\$1,610	\$110	\$293	\$256	\$112	\$134	\$271	\$80
VOX 54 - with glides	\$1,943		\$2,041	\$2,138	\$146	\$389	\$340	N/A	\$134	\$271	\$80
VOX 60 - with glides	\$2,089		\$2,193	\$2,298	\$157	\$418	\$366	N/A	\$134	\$271	\$80
RECTANGLE (REC)											
VOX2 24x60 (2 bases)	\$1,654		\$1,737	\$1,819	\$124	\$331	\$289	N/A	\$268	\$542	\$161
VOX2 24x72 (2 bases)	\$1,726		\$1,812	\$1,898	\$129	\$345	\$302	N/A	\$268	\$542	\$161
VOX2 30x60 (2 bases)	\$2,077		\$2,181	\$2,285	\$156	\$415	\$364	N/A	\$268	\$542	\$161
VOX2 30x72 (2 bases)	\$2,087		\$2,191	\$2,295	\$156	\$417	\$365	N/A	\$268	\$542	\$161
VOX2 36x48 (2 bases)	\$2,753		\$2,891	\$3,028	\$206	\$551	\$482	N/A	\$268	\$542	\$161
VOX2 36x60 (2 bases)	\$2,853		\$2,996	\$3,138	\$214	\$571	\$499	N/A	\$268	\$542	\$161
VOX2 36x72 (2 bases)	\$2,953		\$3,100	\$3,248	\$221	\$591	\$517	N/A	\$268	\$542	\$161

VORTEX TABLES - (LAMINATE - WOOD EDGE)



	Edge Choice: Wood (Red Oak & Maple)			Wood Upgrade	OPTIONS				
	W-12	W-23 W-18 W-16	W-19 W-17 W-32	Upgrade: Walnut / Mahogany / Cherry	FLIP-TOP	POWDERCOAT UPGRADE	CHROME	SPECIAL HEIGHT	
				ADD	ADD	ADD	ADD	ADD	
SQUARE (SQR)									
VOX 24x24 - no glides	\$1,311	\$1,530	\$1,748	15%	\$112	\$134	\$271	\$80	
VOX 30x30 - no glides	\$1,430	\$1,668	\$1,906	15%	\$112	\$134	\$271	\$80	
VOX 36x36 - no glides	\$1,828	\$2,133	\$2,437	15%	\$112	\$134	\$271	\$80	
VOX 42x42 - with glides	\$3,139	\$3,767	\$4,186	15%	\$112	\$134	\$271	\$80	
ROUND (RND)									
VOX 24 - no glides	\$1,357	\$1,584	\$1,810	15%	\$112	\$134	\$271	\$80	
VOX 30 - no glides	\$1,471	\$1,716	\$1,961	15%	\$112	\$134	\$271	\$80	
VOX 36 - no glides	\$1,864	\$2,174	\$2,485	15%	\$112	\$134	\$271	\$80	
VOX 42 - no glides	\$2,524	\$3,028	\$3,365	15%	\$112	\$134	\$271	\$80	
VOX 48 - no glides	\$2,744	\$3,292	\$3,658	15%	\$112	\$134	\$271	\$80	
VOX 54 - with glides	\$3,644	\$4,373	\$4,859	15%	N/A	\$134	\$271	\$80	
VOX 60 - with glides	\$3,916	\$4,699	\$5,222	15%	N/A	\$134	\$271	\$80	
RECTANGLE (REC)									
VOX2 24x60 (2 bases)	\$2,180	\$2,550	\$2,943	15%	N/A	\$268	\$542	\$161	
VOX2 24x72 (2 bases)	\$2,324	\$2,719	\$3,137	15%	N/A	\$268	\$542	\$161	
VOX2 30x60 (2 bases)	\$2,681	\$3,137	\$3,619	15%	N/A	\$268	\$542	\$161	
VOX2 30x72 (2 bases)	\$2,699	\$3,158	\$3,644	15%	N/A	\$268	\$542	\$161	
VOX2 36x48 (2 bases)	\$3,335	\$3,902	\$4,502	15%	N/A	\$268	\$542	\$161	
VOX2 36x60 (2 bases)	\$3,534	\$4,135	\$4,772	15%	N/A	\$268	\$542	\$161	
VOX2 36x72 (2 bases)	\$3,734	\$4,369	\$5,041	15%	N/A	\$268	\$542	\$161	

VORTEX TABLES - (VENEER)



	Edge Choice: Wood (Red Oak & Maple)			Wood Upgrade	OPTIONS				
	V-12	V-23	V-19	Upgrade: Walnut / Mahogany / Cherry	FLIP-TOP	POWDERCOAT UPGRADE	CHROME	SPECIAL HEIGHT	
				ADD	ADD	ADD	ADD	ADD	
SQUARE (SQR)									
VOX 24x24 - no glides	\$1,361	\$1,497	\$1,566	15%	\$112	\$134	\$271	\$80	
VOX 30x30 - no glides	\$1,730	\$1,903	\$1,989	15%	\$112	\$134	\$271	\$80	
VOX 36x36 - no glides	\$2,394	\$2,633	\$2,753	15%	\$112	\$134	\$271	\$80	
VOX 42x42 - with glides	\$3,356	\$3,692	\$3,860	15%	\$112	\$134	\$271	\$80	
ROUND (RND)									
VOX 24 - no glides	\$1,484	\$1,633	\$1,707	15%	\$112	\$134	\$271	\$80	
VOX 30 - no glides	\$1,932	\$2,125	\$2,222	15%	\$112	\$134	\$271	\$80	
VOX 36 - no glides	\$2,692	\$2,961	\$3,096	15%	\$112	\$134	\$271	\$80	
VOX 42 - no glides	\$3,350	\$3,685	\$3,853	15%	\$112	\$134	\$271	\$80	
VOX 48 - no glides	\$4,105	\$4,515	\$4,721	15%	\$112	\$134	\$271	\$80	
VOX 54 - with glides	\$4,486	\$4,935	\$5,159	15%	N/A	\$134	\$271	\$80	
VOX 60 - with glides	\$5,276	\$5,804	\$6,068	15%	N/A	\$134	\$271	\$80	
RECTANGLE (REC)									
VOX2 24x60 (2 bases)	\$2,547	\$2,802	\$2,929	15%	N/A	\$268	\$542	\$161	
VOX2 24x72 (2 bases)	\$2,832	\$3,115	\$3,257	15%	N/A	\$268	\$542	\$161	
VOX2 30x60 (2 bases)	\$3,221	\$3,544	\$3,705	15%	N/A	\$268	\$542	\$161	
VOX2 30x72 (2 bases)	\$4,270	\$4,697	\$4,911	15%	N/A	\$268	\$542	\$161	
VOX2 36x48 (2 bases)	\$3,853	\$4,239	\$4,432	15%	N/A	\$268	\$542	\$161	
VOX2 36x60 (2 bases)	\$4,270	\$4,697	\$4,911	15%	N/A	\$268	\$542	\$161	
VOX2 36x72 (2 bases)	\$4,687	\$5,156	\$5,390	15%	N/A	\$268	\$542	\$161	

VOYAGER



VOYAGER

Voyager tables are manufactured with Berco's goal of quality and value and ideally suited for use in a myriad of settings including corporate training rooms, cafeterias, educational settings and healthcare environments. Your choice of options make our Voyager tables adapt to your specific requirements.

TABLE PEDESTAL SPECIFICATIONS

Finishes: Available in 40+ standard powder coat finishes. Chrome plated finishes are offered at an additional charge. Our unique mechanical construction enables a flawless seam when mixing column finishes with any base finish. Custom finishes available. Please contact Customer Service for quotation.

Glides and Casters: All tables are equipped with 1" diameter stainless steel, rubber cushioned glides with 1" long stem secured with full threaded rivets to maintain stability. Optional styles of glides and casters available at an additional charge.

Stationary VS1 Table Pedestals and VS2 (for tops 42" and 60" wide) Table Pedestals

Constructed of 2" 14 gauge, steel tubing with MIG welded end caps polished for a seamless appearance. Smaller pedestals equipped with powder coated 10" locking cast spider; larger pedestals equipped with 15" cast spider, machined for column recess to insure levelness. 2" diameter (14 gauge) and 3" diameter (16 gauge) columns constructed from welded, flash controlled tubing. Factory assembled with 1/2"-13 threaded steel rod and flange nut at 60 ft/lb torque. Shipped fully assembled.

Stationary VS2 Table End Base Pedestals (for tops 18" to 36" wide)

These double column stationary tables are designed to match Voyager folding tables, 18" to 36" wide. Bases are constructed of 1-1/2" (14 gauge) welded steel tubing with MIG welded end caps, polished for a seamless appearance welded to 6"x8" mounting plate. Columns are 1-1/4" diameter (16 gauge) welded, cold rolled, flash controlled tubing. Packaged in pairs and shipped fully assembled.

Voyager Folding Table Leg Specifications

Our patented spring loaded folding mechanism is fully riveted to a steel mounting plate. Vinyl bumpers are integrated into the mechanism allowing for a non-marring, 3-1/2" stacking height. Equipped with molded release handle, integral catch holds leg in folded position. Folding legs are constructed of welded, cold rolled steel tubing with MIG welded end caps, polished for seamless appearance. Columns are permanently bolted to the base for a seamless appearance and fully TIG welded to the folding mechanism.

VS2 Fold: Folding tubular legs complement the VS2 Double Column End Base Pedestals and are constructed with 1-1/2", 14 gauge steel tubing. Columns are 1-1/4" diameter, 16 gauge, steel tubing.

VS1 Fold: Folding tubular legs are designed to match the VS1 Single Column End Base Pedestals, constructed of 2" diameter 14 gauge steel tubing. The column is 2" diameter, 14 gauge steel tubing.

Voyager Table Options

There are several options available on Voyager including:

- Nesting
- Folding
- Flip Top
- Adjustable Height
- Special Height
- Angle Base
- Offset Base
- Center Mount Electrical Column

VOYAGER

VOYAGER BASE SPECIFICATIONS

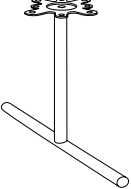
<u>Single Column End Base</u>	<u>Smart Code</u>	<u>Base Size</u>	<u>Column Diameter</u>	<u>Top Capacity</u>
	VS1-16EB	16"	2"	18"x96"
	VS1-20EB	20"	2"	24"x96"
	VS1-26EB	26"	2"	36"x96"

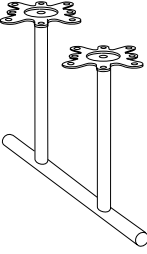
<u>Double Column End Base</u>	<u>Smart Code</u>	<u>Base Size</u>	<u>Column Diameter</u>	<u>Top Capacity</u>
	VS2-16EB	16"	1-1/4"	18"x96"
	VS2-20EB	20"	1-1/4"	24"x96"
	VS2-26EB	26"	1-1/4"	36"x96"
	VS2-32EB	32"	2"	42"x96"
	VS2-38EB	38"	2"	48"x96"
	VS2-42EB	42"	2"	60"x96"

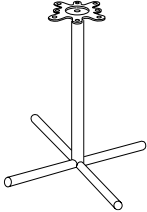
<u>Cross Base</u>	<u>Smart Code</u>	<u>Base Size</u>	<u>Column Diameter</u>	<u>Top Capacity</u>
	VSX-22	22"	3"	24" SQ & RND
	VSX-26	26"	3"	30" SQ & RND
	VSX-32	32"	3"	36" SQ & 42" RND
	VSX-38	38"	4"	42" SQ & 60" RND
	VSX-38-5	38" x 5	2" & 3"	60" SQ & 72" RND
	VSX-2226	22"x26"	3"	24"x36"
	VSX-2638	26"x38"	4"	30"x48"
	VSX-3238	32"x38"	4"	36"x48"







VSX - VOYAGER TABLES - X BASE (LAMINATE - PVC EDGE)



		Edge Choices: PVC & T-Mold				Laminate Upgrades		Light Wt.	OPTIONS							
		T-15	L-21	P-14	PK-2	Laminate Upgrade I	Laminate Upgrade II	Light Weight (PVC only - 1" top)	FLIP TOP	POWDERCOAT UPGRADE	CHROME	DELUXE CASTERS (BLK)	EQUALIZER GLIDES	CENTER MOUNT ELEC. COLUMN	ADJ. HEIGHT	SPECIAL HEIGHT
		P-10 (self)	P-12		PK-4	ADD	ADD	ADD	ADD	ADD	ADD	ADD	ADD	ADD	ADD	ADD
		L-15			L-23											
SQUARE (SQR)																
VSX	24x24	\$690	\$724	\$759	\$52	\$138	\$121	\$112	\$134	\$271	\$163	\$61	\$338	CF	\$80	
VSX	30x30	\$771	\$810	\$849	\$58	\$154	\$135	\$112	\$134	\$271	\$163	\$61	\$338	CF	\$80	
VSX	36x36	\$863	\$907	\$950	\$65	\$173	\$151	\$112	\$134	\$271	\$163	\$61	\$338	CF	\$80	
VSX	42x42	\$1,051	\$1,104	\$1,156	\$79	\$210	\$184	\$112	\$134	\$271	\$163	\$61	\$338	CF	\$80	
VSX	48x48	\$1,166	\$1,224	\$1,282	\$87	\$233	\$204	N/A	\$134	\$271	\$163	\$61	N/A	CF	\$80	
ROUND (RND)																
VSX	24	\$719	\$755	\$791	\$54	\$144	\$126	\$112	\$134	\$271	\$163	\$61	\$338	CF	\$80	
VSX	30	\$797	\$837	\$877	\$60	\$159	\$140	\$112	\$134	\$271	\$163	\$61	\$338	CF	\$80	
VSX	36	\$886	\$930	\$975	\$66	\$177	\$155	\$112	\$134	\$271	\$163	\$61	\$338	CF	\$80	
VSX	42	\$984	\$1,033	\$1,083	\$74	\$197	\$172	\$112	\$134	\$271	\$163	\$61	\$338	CF	\$80	
VSX	48	\$1,182	\$1,241	\$1,300	\$89	\$236	\$207	\$112	\$134	\$271	\$163	\$61	\$338	CF	\$80	
VSX	54	\$1,307	\$1,372	\$1,437	\$98	\$261	\$229	N/A	\$134	\$271	\$163	\$61	N/A	CF	\$80	
VSX	60	\$1,445	\$1,517	\$1,589	\$108	\$289	\$253	N/A	\$134	\$271	\$163	\$61	N/A	CF	\$80	
VSX5	72 (2 piece)	\$2,439	\$2,561	\$2,683	\$183	\$488	\$427	N/A	\$134	\$271	\$163	\$61	N/A	CF	\$80	
RECTANGLE (REC)																
VSX2226	24x30	\$731	\$767	\$804	\$55	\$146	\$128	\$112	\$134	\$271	\$163	\$61	\$338	CF	\$80	
VSX2226	24x36	\$765	\$803	\$841	\$57	\$153	\$134	\$112	\$134	\$271	\$163	\$61	\$338	CF	\$80	
VSX2638	30x42	\$936	\$983	\$1,030	\$70	\$187	\$164	\$112	\$134	\$271	\$163	\$61	\$338	CF	\$80	
VSX2638	30x48	\$977	\$1,026	\$1,075	\$73	\$195	\$171	\$112	\$134	\$271	\$163	\$61	N/A	CF	\$80	
VSX3238	36x42	\$990	\$1,040	\$1,089	\$74	\$198	\$173	\$112	\$134	\$271	\$163	\$61	\$338	CF	\$80	
VSX3238	36x48	\$1,038	\$1,090	\$1,142	\$78	\$208	\$182	\$112	\$134	\$271	\$163	\$61	N/A	CF	\$80	

VSX - VOYAGER TABLES - X BASE (LAMINATE - WOOD EDGE)



		Edge Choices: Wood (Red Oak & Maple)			Wood Upgrade	OPTIONS								
		 W-12	 W-23	 W-19	Upgrade: Walnut / Mahogany / Cherry	FLIP TOP	POWDERCOAT UPGRADE	CHROME	DELUXE CASTERS (BKL)	EQUALIZER GLIDES	CENTER MOUNT ELEC. COLUMN	ADJ. HEIGHT	SPECIAL HEIGHT	
		 W-18	 W-17											
		 W-16	 W-32											
SQUARE (SQR)														
VSX	24x24	\$1,034	\$1,207	\$1,379	15%	\$112	\$134	\$271	\$163	\$61	\$338	CF	\$80	
VSX	30x30	\$1,157	\$1,350	\$1,543	15%	\$112	\$134	\$271	\$163	\$61	\$338	CF	\$80	
VSX	36x36	\$1,295	\$1,511	\$1,727	15%	\$112	\$134	\$271	\$163	\$61	\$338	CF	\$80	
VSX	42x42	\$1,971	\$2,365	\$2,628	15%	\$112	\$134	\$271	\$163	\$61	\$338	CF	\$80	
VSX	48x48	\$2,186	\$2,623	\$2,914	15%	N/A	\$134	\$271	\$163	\$61	N/A	CF	\$80	
ROUND (RND)														
VSX	24	\$1,078	\$1,258	\$1,438	15%	\$112	\$134	\$271	\$163	\$61	\$338	CF	\$80	
VSX	30	\$1,196	\$1,396	\$1,595	15%	\$112	\$134	\$271	\$163	\$61	\$338	CF	\$80	
VSX	36	\$1,329	\$1,551	\$1,772	15%	\$112	\$134	\$271	\$163	\$61	\$338	CF	\$80	
VSX	42	\$1,846	\$2,215	\$2,461	15%	\$112	\$134	\$271	\$163	\$61	\$338	CF	\$80	
VSX	48	\$2,216	\$2,659	\$2,955	15%	\$112	\$134	\$271	\$163	\$61	\$338	CF	\$80	
VSX	54	\$2,450	\$2,940	\$3,267	15%	N/A	\$134	\$271	\$163	\$61	N/A	CF	\$80	
VSX	60	\$2,709	\$3,250	\$3,611	15%	N/A	\$134	\$271	\$163	\$61	N/A	CF	\$80	
VSX5	72 (2 piece)	\$4,573	\$5,488	\$6,097	15%	N/A	\$134	\$271	\$163	\$61	N/A	CF	\$80	
RECTANGLE (REC)														
VSX2226	24x30	\$1,096	\$1,279	\$1,461	15%	\$112	\$134	\$271	\$163	\$61	\$338	CF	\$80	
VSX2226	24x36	\$1,147	\$1,338	\$1,530	15%	\$112	\$134	\$271	\$163	\$61	\$338	CF	\$80	
VSX2638	30x42	\$1,405	\$1,639	\$1,873	15%	\$112	\$134	\$271	\$163	\$61	\$338	CF	\$80	
VSX2638	30x48	\$1,466	\$1,710	\$1,954	15%	\$112	\$134	\$271	\$163	\$61	N/A	CF	\$80	
VSX3238	36x42	\$1,486	\$1,733	\$1,981	15%	\$112	\$134	\$271	\$163	\$61	\$338	CF	\$80	
VSX3238	36x48	\$1,557	\$1,816	\$2,076	15%	\$112	\$134	\$271	\$163	\$61	N/A	CF	\$80	

VSX - VOYAGER TABLES - X BASE (VENEER)



		Edge Choices: Wood (Red Oak & Maple)			Wood Upgrade	OPTIONS							
		V-12	V-23	V-19	Upgrade: Walnut / Mahogany / Cherry	FLIP TOP	POWDERCOAT UPGRADE	CHROME	DELUXE CASTERS (BLK)	EQUALIZER GLIDES	CENTER MOUNT ELEC. COLUMN	ADJ. HEIGHT	SPECIAL HEIGHT
			V-18	V-17									
			V-16	V-32									
SQUARE (SQR)													
VSX	24x24	\$1,085	\$1,193	\$1,248	15%	\$112	\$134	\$271	\$163	\$61	\$338	CF	\$80
VSX	30x30	\$1,301	\$1,431	\$1,496	15%	\$112	\$134	\$271	\$163	\$61	\$338	CF	\$80
VSX	36x36	\$1,685	\$1,853	\$1,938	15%	\$112	\$134	\$271	\$163	\$61	\$338	CF	\$80
VSX	42x42	\$2,229	\$2,452	\$2,563	15%	\$112	\$134	\$271	\$163	\$61	\$338	CF	\$80
VSX	48x48	\$2,755	\$3,031	\$3,169	15%	N/A	\$134	\$271	\$163	\$61	N/A	CF	\$80
ROUND (RND)													
VSX	24	\$1,089	\$1,197	\$1,252	15%	\$112	\$134	\$271	\$163	\$61	\$338	CF	\$80
VSX	30	\$1,469	\$1,616	\$1,689	15%	\$112	\$134	\$271	\$163	\$61	\$338	CF	\$80
VSX	36	\$1,933	\$2,127	\$2,223	15%	\$112	\$134	\$271	\$163	\$61	\$338	CF	\$80
VSX	42	\$2,482	\$2,730	\$2,854	15%	\$112	\$134	\$271	\$163	\$61	\$338	CF	\$80
VSX	48	\$3,202	\$3,522	\$3,682	15%	\$112	\$134	\$271	\$163	\$61	\$338	CF	\$80
VSX	54	\$3,918	\$4,310	\$4,506	15%	N/A	\$134	\$271	\$163	\$61	N/A	CF	\$80
VSX	60	\$4,708	\$5,179	\$5,414	15%	N/A	\$134	\$271	\$163	\$61	N/A	CF	\$80
VSX5	72 (2 piece)	\$7,120	\$7,832	\$8,188	15%	N/A	\$134	\$271	\$163	\$61	N/A	CF	\$80
RECTANGLE (REC)													
VSX2226	24x30	\$1,132	\$1,246	\$1,302	15%	\$112	\$134	\$271	\$163	\$61	\$338	CF	\$80
VSX2226	24x36	\$1,279	\$1,407	\$1,471	15%	\$112	\$134	\$271	\$163	\$61	\$338	CF	\$80
VSX2638	30x42	\$1,769	\$1,946	\$2,034	15%	\$112	\$134	\$271	\$163	\$61	\$338	CF	\$80
VSX2638	30x48	\$1,908	\$2,098	\$2,194	15%	\$112	\$134	\$271	\$163	\$61	N/A	CF	\$80
VSX3238	36x42	\$2,017	\$2,219	\$2,320	15%	\$112	\$134	\$271	\$163	\$61	\$338	CF	\$80
VSX3238	36x48	\$2,193	\$2,412	\$2,522	15%	\$112	\$134	\$271	\$163	\$61	N/A	CF	\$80

VS1 - VOYAGER TABLES - SINGLE COLUMN END BASE (LAMINATE - PVC EDGE)



	Edge Choices: PVC & T-Mold				Laminate Upgrades		Light Weight	OPTIONS							
	T-15 P-10 (self) L-15	L-21 P-12	P-14	PK-2 PK-4 L-23	Laminate Upgrade I ADD	Laminate Upgrade II ADD	Light Weight (PVC only - 1" top) ADD	NESTING ADD	FOLDING ADD	POWDERCOAT UPGRADE ADD	CHROME ADD	DELUXE CASTERS (BLK) ADD	EQUALIZER GLIDES ADD	ADJ. HEIGHT PIN ADD	SPECIAL HEIGHT ADD
RECTANGLE (REC)															
VS1 18x48	\$844		\$886	\$928	\$63	\$169	\$148	\$389	N/A	\$134	\$339	\$163	\$61	N/A	\$133
VS1 18x60	\$899		\$944	\$989	\$67	\$180	\$157	\$389	\$424	\$134	\$339	\$163	\$61	N/A	\$133
VS1 18x72	\$954		\$1,002	\$1,049	\$72	\$191	\$167	\$389	\$424	\$134	\$339	\$163	\$61	N/A	\$133
VS1 18x84	\$1,009		\$1,060	\$1,110	\$76	\$202	\$177	\$389	\$424	\$134	\$339	\$163	\$61	N/A	\$133
VS1 18x96	\$1,064		\$1,117	\$1,171	\$80	\$213	\$186	\$389	\$424	\$134	\$339	\$163	\$61	N/A	\$133
VS1 24x48	\$913		\$959	\$1,005	\$68	\$183	\$160	\$389	N/A	\$134	\$339	\$163	\$61	\$711	\$133
VS1 24x60	\$982		\$1,031	\$1,080	\$74	\$196	\$172	\$389	\$424	\$134	\$339	\$163	\$61	\$711	\$133
VS1 24x72	\$1,050		\$1,102	\$1,155	\$79	\$210	\$184	\$389	\$424	\$134	\$339	\$163	\$61	\$711	\$133
VS1 24x84	\$1,118		\$1,174	\$1,230	\$84	\$224	\$196	\$389	\$424	\$134	\$339	\$163	\$61	N/A	\$133
VS1 24x96	\$1,187		\$1,246	\$1,305	\$89	\$237	\$208	\$389	\$424	\$134	\$339	\$163	\$61	N/A	\$133
VS1 24x120 (1 piece)	\$1,647		\$1,729	\$1,811	\$123	\$329	N/A	N/A	N/A	\$134	\$339	\$244	\$91	N/A	\$133
VS1 24x144 (1 piece)	\$1,790		\$1,880	\$1,969	\$134	\$358	N/A	N/A	N/A	\$134	\$339	\$244	\$91	N/A	\$133
VS1 30x48	\$990		\$1,040	\$1,089	\$74	\$198	\$173	\$389	N/A	\$134	\$339	\$163	\$61	\$711	\$133
VS1 30x60	\$1,072		\$1,125	\$1,179	\$80	\$214	\$188	\$389	\$424	\$134	\$339	\$163	\$61	\$711	\$133
VS1 30x72	\$1,080		\$1,135	\$1,189	\$81	\$216	\$189	\$389	\$424	\$134	\$339	\$163	\$61	\$711	\$133
VS1 30x84	\$1,235		\$1,297	\$1,358	\$93	\$247	\$216	\$389	\$424	\$134	\$339	\$163	\$61	N/A	\$133
VS1 30x96	\$1,316		\$1,382	\$1,448	\$99	\$263	\$230	\$389	\$424	\$134	\$339	\$163	\$61	N/A	\$133
VS1 30x120 (1 piece)	\$1,820		\$1,911	\$2,002	\$136	\$364	N/A	N/A	N/A	\$134	\$339	\$244	\$91	N/A	\$133
VS1 30x144 (1 piece)	\$1,991		\$2,091	\$2,191	\$149	\$398	N/A	N/A	N/A	\$134	\$339	\$244	\$91	N/A	\$133
VS1 36x48	\$1,051		\$1,103	\$1,156	\$79	\$210	\$184	\$389	N/A	\$134	\$339	\$163	\$61	N/A	\$133
VS1 36x60	\$1,146		\$1,203	\$1,260	\$86	\$229	\$200	\$389	\$424	\$134	\$339	\$163	\$61	N/A	\$133
VS1 36x72	\$1,240		\$1,302	\$1,365	\$93	\$248	\$217	\$389	\$424	\$134	\$339	\$163	\$61	N/A	\$133
VS1 36x84	\$1,335		\$1,402	\$1,469	\$100	\$267	\$234	\$389	\$424	\$134	\$339	\$163	\$61	N/A	\$133
VS1 36x96	\$1,430		\$1,502	\$1,573	\$107	\$286	\$250	\$389	\$424	\$134	\$339	\$163	\$61	N/A	\$133
VS1 36x120 (1 piece)	\$1,967		\$2,066	\$2,164	\$148	\$393	N/A	N/A	N/A	\$134	\$339	\$244	\$91	N/A	\$133
VS1 36x144 (1 piece)	\$2,167		\$2,275	\$2,384	\$163	\$433	N/A	N/A	N/A	\$134	\$339	\$244	\$91	N/A	\$133
RACETRACK (RAC)															
VS1 36x72	\$1,325		\$1,392	\$1,458	\$99	\$265	\$232	\$389	\$424	\$134	\$339	\$163	\$61	N/A	\$133
VS1 36x84	\$1,420		\$1,491	\$1,562	\$107	\$284	\$249	\$389	\$424	\$134	\$339	\$163	\$61	N/A	\$133
VS1 36x96	\$1,515		\$1,591	\$1,667	\$114	\$303	\$265	\$389	\$424	\$134	\$339	\$163	\$61	N/A	\$133
OVAL (OVL)															
VS1 36x60	\$1,231		\$1,292	\$1,354	\$92	\$246	\$215	\$389	N/A	\$134	\$339	\$163	\$61	N/A	\$133
VS1 36x72	\$1,325		\$1,392	\$1,458	\$99	\$265	\$232	\$389	\$424	\$134	\$339	\$163	\$61	N/A	\$133
VS1 36x84	\$1,420		\$1,491	\$1,562	\$107	\$284	\$249	\$389	\$424	\$134	\$339	\$163	\$61	N/A	\$133
VS1 36x96	\$1,515		\$1,591	\$1,667	\$114	\$303	\$265	\$389	\$424	\$134	\$339	\$163	\$61	N/A	\$133







VS1 - VOYAGER TABLES - SINGLE COLUMN END BASE (LAMINATE - PVC EDGE)



	Edge Choices: PVC & T-Mold				Laminate Upgrades		Light Weight	OPTIONS								
	T-15	L-21	P-14	PK-2	Laminate Upgrade I	Laminate Upgrade II	Light Weight (PVC only - 1" top)	NESTING	FOLDING	POWDERCOAT UPGRADE	CHROME	DELUXE CASTERS (BLK)	EQUALIZER GLIDES	ADJ. HEIGHT PIN	SPECIAL HEIGHT	
	P-10 (self)	P-12		PK-4	ADD	ADD	ADD	ADD	ADD	ADD	ADD	ADD	ADD	ADD	ADD	
TRAPEZOID (TRP)																
VS1 24x24x48	\$990	\$1,039	\$1,088	\$74	\$198	\$173	\$389	N/A	\$134	\$339	\$163	\$61	CF	\$133		
VS1 24x36x60	\$1,206	\$1,266	\$1,326	\$90	\$241	\$211	\$389	N/A	\$134	\$339	\$163	\$61	CF	\$133		
VS1 30x30x60	\$1,140	\$1,197	\$1,254	\$86	\$228	\$200	\$389	N/A	\$134	\$339	\$163	\$61	CF	\$133		
VS1 30x42x72	\$1,396	\$1,466	\$1,536	\$105	\$279	\$244	\$389	N/A	\$134	\$339	\$163	\$61	CF	\$133		
VS1 36x36x72	\$1,325	\$1,392	\$1,458	\$99	\$265	\$232	\$389	N/A	\$134	\$339	\$163	\$61	CF	\$133		
HALF ROUND (HRD)																
VS1 24x48	\$934	\$981	\$1,027	\$70	\$187	\$163	\$389	N/A	\$134	\$339	\$163	\$61	CF	\$133		
VS1 30x60	\$1,082	\$1,136	\$1,190	\$81	\$216	\$189	\$389	N/A	\$134	\$339	\$163	\$61	CF	\$133		
VS1 36x72	\$1,263	\$1,326	\$1,390	\$95	\$253	\$221	\$389	N/A	\$134	\$339	\$163	\$61	CF	\$133		
QTR ROUND (QRD)																
VS1 24x24	\$810	\$851	\$891	\$61	\$162	\$142	N/A	N/A	\$134	\$339	\$163	\$61	CF	\$133		
VS1 30x30	\$894	\$939	\$983	\$67	\$179	\$156	N/A	N/A	\$134	\$339	\$163	\$61	CF	\$133		
VS1 36x36	\$998	\$1,048	\$1,098	\$75	\$200	\$175	N/A	N/A	\$134	\$339	\$163	\$61	CF	\$133		
CRESCENT (CRT)																
VS1 24x24x48	\$998	\$1,048	\$1,098	\$75	\$200	\$175	\$389	N/A	\$134	\$339	\$163	\$61	CF	\$133		
VS1 30x30x60	\$1,157	\$1,214	\$1,272	\$87	\$231	\$202	\$389	N/A	\$134	\$339	\$163	\$61	CF	\$133		
VS1 36x36x72	\$1,325	\$1,392	\$1,458	\$99	\$265	\$232	\$389	N/A	\$134	\$339	\$163	\$61	CF	\$133		







VS1 - VOYAGER TABLES - SINGLE COLUMN (LAMINATE - WOOD EDGE)



	Edge Choices: Wood (Red Oak & Maple)			Wood Upgrade	OPTIONS								
				Upgrade: Walnut / Mahogany / Cherry	NESTING	FOLDING	POWDERCOAT UPGRADE	CHROME	DELUXE CASTERS (BLK)	EQUALIZER GLIDES	ADJ. HEIGHT PIN	SPECIAL HEIGHT	
													
RECTANGLE (REC)													
VS1 18x48	\$1,266	\$1,477	\$1,688	15%	\$389	N/A	\$134	\$339	\$163	\$61	N/A	\$133	
VS1 18x60	\$1,348	\$1,573	\$1,798	15%	\$389	\$424	\$134	\$339	\$163	\$61	N/A	\$133	
VS1 18x72	\$1,431	\$1,670	\$1,908	15%	\$389	\$424	\$134	\$339	\$163	\$61	N/A	\$133	
VS1 18x84	\$1,596	\$1,862	\$2,128	15%	\$389	\$424	\$134	\$339	\$163	\$61	N/A	\$133	
VS1 18x96	\$1,596	\$1,862	\$2,128	15%	\$389	\$424	\$134	\$339	\$163	\$61	N/A	\$133	
VS1 24x48	\$1,370	\$1,598	\$1,827	15%	\$389	N/A	\$134	\$339	\$163	\$61	\$711	\$133	
VS1 24x60	\$1,472	\$1,718	\$1,963	15%	\$389	\$424	\$134	\$339	\$163	\$61	\$711	\$133	
VS1 24x72	\$1,575	\$1,837	\$2,100	15%	\$389	\$424	\$134	\$339	\$163	\$61	\$711	\$133	
VS1 24x84	\$1,780	\$2,076	\$2,373	15%	\$389	\$424	\$134	\$339	\$163	\$61	N/A	\$133	
VS1 24x96	\$1,780	\$2,076	\$2,373	15%	\$389	\$424	\$134	\$339	\$163	\$61	N/A	\$133	
VS1 24x120 (1 piece)	CF	CF	CF	CF	N/A	N/A	\$134	\$339	\$244	\$91	N/A	\$133	
VS1 24x144 (1 piece)	CF	CF	CF	CF	N/A	N/A	\$134	\$339	\$244	\$91	N/A	\$133	
VS1 30x48	\$1,485	\$1,733	\$1,980	15%	\$389	N/A	\$134	\$339	\$163	\$61	\$711	\$133	
VS1 30x60	\$1,608	\$1,875	\$2,143	15%	\$389	\$424	\$134	\$339	\$163	\$61	\$711	\$133	
VS1 30x72	\$1,621	\$1,891	\$2,161	15%	\$389	\$424	\$134	\$339	\$163	\$61	\$711	\$133	
VS1 30x84	\$1,975	\$2,304	\$2,633	15%	\$389	\$424	\$134	\$339	\$163	\$61	N/A	\$133	
VS1 30x96	\$1,975	\$2,304	\$2,633	15%	\$389	\$424	\$134	\$339	\$163	\$61	N/A	\$133	
VS1 30x120 (1 piece)	CF	CF	CF	CF	N/A	N/A	\$134	\$339	\$244	\$91	N/A	\$133	
VS1 30x144 (1 piece)	CF	CF	CF	CF	N/A	N/A	\$134	\$339	\$244	\$91	N/A	\$133	
VS1 36x48	\$1,576	\$1,839	\$2,102	15%	\$389	N/A	\$134	\$339	\$163	\$61	N/A	\$133	
VS1 36x60	\$1,718	\$2,005	\$2,291	15%	\$389	\$424	\$134	\$339	\$163	\$61	N/A	\$133	
VS1 36x72	\$1,861	\$2,171	\$2,481	15%	\$389	\$424	\$134	\$339	\$163	\$61	N/A	\$133	
VS1 36x84	\$2,145	\$2,503	\$2,860	15%	\$389	\$424	\$134	\$339	\$163	\$61	N/A	\$133	
VS1 36x96	\$2,145	\$2,503	\$2,860	15%	\$389	\$424	\$134	\$339	\$163	\$61	N/A	\$133	
VS1 36x120 (1 piece)	\$2,951	\$3,443	\$3,935	15%	N/A	N/A	\$134	\$339	\$244	\$91	N/A	\$133	
VS1 36x144 (1 piece)	CF	CF	CF	CF	N/A	N/A	\$134	\$339	\$244	\$91	N/A	\$133	
RACETRACK (RAC)													
VS1 36x72	\$1,988	\$2,319	\$2,651	15%	\$389	\$424	\$134	\$339	\$163	\$61	N/A	\$133	
VS1 36x84	\$2,273	\$2,651	\$3,030	15%	\$389	\$424	\$134	\$339	\$163	\$61	N/A	\$133	
VS1 36x96	\$2,273	\$2,651	\$3,030	15%	\$389	\$424	\$134	\$339	\$163	\$61	N/A	\$133	
OVAL (OVL)													
VS1 36x60	N/A	N/A	N/A	N/A	\$389	N/A	\$134	\$339	\$163	\$61	N/A	\$133	
VS1 36x72	\$1,988	\$2,319	\$2,651	15%	\$389	\$424	\$134	\$339	\$163	\$61	N/A	\$133	
VS1 36x84	\$2,273	\$2,651	\$3,030	15%	\$389	\$424	\$134	\$339	\$163	\$61	N/A	\$133	
VS1 36x96	\$2,273	\$2,651	\$3,030	15%	\$389	\$424	\$134	\$339	\$163	\$61	N/A	\$133	



VS1 - VOYAGER TABLES - SINGLE COLUMN (LAMINATE - WOOD EDGE)



	Edge Choices: Wood (Red Oak & Maple)			Wood Upgrade	OPTIONS							
	W-12	W-23	W-19	Upgrade: Walnut / Mahogany / Cherry	NESTING	FOLDING	POWDERCOAT UPGRADE	CHROME	DELUXE CASTERS (BLK)	EQUALIZER GLIDES	ADJ. HEIGHT PIN	SPECIAL HEIGHT
												
												
												
					ADD	ADD	ADD	ADD	ADD	ADD	ADD	ADD
TRAPEZOID (TRP)												
VS1 24x24x48	\$1,484	\$1,722	\$1,974	15%	\$389	N/A	\$134	\$339	\$163	\$61	CF	\$133
VS1 24x36x60	\$1,809	\$2,098	\$2,405	15%	\$389	N/A	\$134	\$339	\$163	\$61	CF	\$133
VS1 30x30x60	\$1,711	\$1,984	\$2,275	15%	\$389	N/A	\$134	\$339	\$163	\$61	CF	\$133
VS1 30x42x72	\$2,095	\$2,430	\$2,786	15%	\$389	N/A	\$134	\$339	\$163	\$61	CF	\$133
VS1 36x36x72	\$1,988	\$2,306	\$2,644	15%	\$389	N/A	\$134	\$339	\$163	\$61	CF	\$133
HALF ROUND (HRD)												
VS1 24x48	\$1,401	\$1,625	\$1,863	15%	\$389	N/A	\$134	\$339	\$163	\$61	CF	\$133
VS1 30x60	\$1,622	\$1,882	\$2,158	15%	\$389	N/A	\$134	\$339	\$163	\$61	CF	\$133
VS1 36x72	\$1,895	\$2,198	\$2,520	15%	\$389	N/A	\$134	\$339	\$163	\$61	CF	\$133
QTR ROUND (QRD)												
VS1 24x24	\$1,216	\$1,410	\$1,617	15%	N/A	N/A	\$134	\$339	\$163	\$61	CF	\$133
VS1 30x30	\$1,341	\$1,556	\$1,784	15%	N/A	N/A	\$134	\$339	\$163	\$61	CF	\$133
VS1 36x36	\$1,498	\$1,737	\$1,992	15%	N/A	N/A	\$134	\$339	\$163	\$61	CF	\$133
CRESCENT (CRT)												
VS1 24x24x48	\$1,497	\$1,737	\$1,991	15%	\$389	N/A	\$134	\$339	\$163	\$61	CF	\$133
VS1 30x30x60	\$1,735	\$2,012	\$2,307	15%	\$389	N/A	\$134	\$339	\$163	\$61	CF	\$133
VS1 36x36x72	\$1,988	\$2,306	\$2,644	15%	\$389	N/A	\$134	\$339	\$163	\$61	CF	\$133

VS1 - VOYAGER TABLES - SINGLE COLUMN END BASE (VENEER)



	Edge Choices: Wood (Red Oak & Maple)			Wood Upgrade	OPTIONS							
				Upgrade: Walnut / Mahogany / Cherry	NESTING	POWDERCOAT UPGRADE	CHROME	DELUXE CASTERS (BLK)	EQUALIZER GLIDES	ADJ. HEIGHT PIN	SPECIAL HEIGHT	
	V-12	V-23	V-19									ADD
RECTANGLE (REC)												
VS1 18x48	\$1,639	\$1,803	\$1,885	15%	\$389	\$134	\$339	\$163	\$61	N/A	\$133	
VS1 18x60	\$1,917	\$2,109	\$2,205	15%	\$389	\$134	\$339	\$163	\$61	N/A	\$133	
VS1 18x72	\$2,202	\$2,422	\$2,533	15%	\$389	\$134	\$339	\$163	\$61	N/A	\$133	
VS1 18x84	\$2,773	\$3,050	\$3,189	15%	\$389	\$134	\$339	\$163	\$61	N/A	\$133	
VS1 18x96	\$2,773	\$3,050	\$3,189	15%	\$389	\$134	\$339	\$163	\$61	N/A	\$133	
VS1 24x48	\$1,648	\$1,813	\$1,895	15%	\$389	\$134	\$339	\$163	\$61	\$711	\$133	
VS1 24x60	\$1,926	\$2,119	\$2,215	15%	\$389	\$134	\$339	\$163	\$61	\$711	\$133	
VS1 24x72	\$2,211	\$2,432	\$2,543	15%	\$389	\$134	\$339	\$163	\$61	\$711	\$133	
VS1 24x84	\$2,782	\$3,060	\$3,199	15%	\$389	\$134	\$339	\$163	\$61	N/A	\$133	
VS1 24x96	\$2,782	\$3,060	\$3,199	15%	\$389	\$134	\$339	\$163	\$61	N/A	\$133	
VS1 24x120 (1 piece)	CF	CF	CF	CF	N/A	\$134	\$339	\$244	\$91	N/A	\$133	
VS1 24x144 (1 piece)	CF	CF	CF	CF	N/A	\$134	\$339	\$244	\$91	N/A	\$133	
VS1 30x48	\$1,921	\$2,113	\$2,209	15%	\$389	\$134	\$339	\$163	\$61	\$711	\$133	
VS1 30x60	\$2,272	\$2,499	\$2,613	15%	\$389	\$134	\$339	\$163	\$61	\$711	\$133	
VS1 30x72	\$2,623	\$2,886	\$3,017	15%	\$389	\$134	\$339	\$163	\$61	\$711	\$133	
VS1 30x84	\$3,325	\$3,658	\$3,824	15%	\$389	\$134	\$339	\$163	\$61	N/A	\$133	
VS1 30x96	\$3,325	\$3,658	\$3,824	15%	\$389	\$134	\$339	\$163	\$61	N/A	\$133	
VS1 30x120 (1 piece)	CF	CF	CF	CF	N/A	\$134	\$339	\$244	\$91	N/A	\$133	
VS1 30x144 (1 piece)	CF	CF	CF	CF	N/A	\$134	\$339	\$244	\$91	N/A	\$133	
VS1 36x48	\$2,206	\$2,427	\$2,537	15%	\$389	\$134	\$339	\$163	\$61	N/A	\$133	
VS1 36x60	\$2,623	\$2,886	\$3,017	15%	\$389	\$134	\$339	\$163	\$61	N/A	\$133	
VS1 36x72	\$3,040	\$3,344	\$3,496	15%	\$389	\$134	\$339	\$163	\$61	N/A	\$133	
VS1 36x84	\$3,881	\$4,269	\$4,463	15%	\$389	\$134	\$339	\$163	\$61	N/A	\$133	
VS1 36x96	\$3,881	\$4,269	\$4,463	15%	\$389	\$134	\$339	\$163	\$61	N/A	\$133	
VS1 36x120 (1 piece)	CF	CF	CF	CF	N/A	\$134	\$339	\$244	\$91	N/A	\$133	
VS1 36x144 (1 piece)	CF	CF	CF	CF	N/A	\$134	\$339	\$244	\$91	N/A	\$133	
RACETRACK (RAC)												
VS1 36x72	\$3,581	\$3,939	\$4,118	15%	\$389	\$134	\$339	\$163	\$61	N/A	\$133	
VS1 36x84	\$4,415	\$4,856	\$5,077	15%	\$389	\$134	\$339	\$163	\$61	N/A	\$133	
VS1 36x96	\$4,415	\$4,856	\$5,077	15%	\$389	\$134	\$339	\$163	\$61	N/A	\$133	
OVAL (OVL)												
VS1 36x60	\$3,859	\$4,245	\$4,438	15%	\$389	\$134	\$339	\$163	\$61	N/A	\$133	
VS1 36x72	\$3,859	\$4,245	\$4,438	15%	\$389	\$134	\$339	\$163	\$61	N/A	\$133	
VS1 36x84	\$4,971	\$5,468	\$5,716	15%	\$389	\$134	\$339	\$163	\$61	N/A	\$133	
VS1 36x96	\$4,971	\$5,468	\$5,716	15%	\$389	\$134	\$339	\$163	\$61	N/A	\$133	

VS1 - VOYAGER TABLES - SINGLE COLUMN END BASE (VENEER)



	Edge Choices: Wood (Red Oak & Maple)			Wood Upgrade	OPTIONS							
	V-12	V-23 V-18 V-16	V-19 V-17 V-32	Upgrade: Walnut / Mahogany / Cherry	NESTING	POWDERCOAT UPGRADE	CHROME	DELUXE CASTERS (BLK)	EQUALIZER GLIDES	ADJ. HEIGHT PIN	SPECIAL HEIGHT	
				ADD	ADD	ADD	ADD	ADD	ADD	ADD	ADD	
TRAPEZOID (TRP)												
VS1 24x24x48	\$3,117	\$3,429	\$3,585	15%	\$389	\$134	\$339	\$163	\$61	CF	\$133	
VS1 24x36x60	\$3,798	\$4,178	\$4,368	15%	\$389	\$134	\$339	\$163	\$61	CF	\$133	
VS1 30x30x60	\$3,592	\$3,952	\$4,131	15%	\$389	\$134	\$339	\$163	\$61	CF	\$133	
VS1 30x42x72	\$4,399	\$4,839	\$5,058	15%	\$389	\$134	\$339	\$163	\$61	CF	\$133	
VS1 36x36x72	\$4,175	\$4,592	\$4,801	15%	\$389	\$134	\$339	\$163	\$61	CF	\$133	
HALF ROUND (HRD)												
VS1 24x48	\$2,942	\$3,236	\$3,383	15%	\$389	\$134	\$339	\$163	\$61	CF	\$133	
VS1 30x60	\$3,407	\$3,748	\$3,918	15%	\$389	\$134	\$339	\$163	\$61	CF	\$133	
VS1 36x72	\$3,979	\$4,377	\$4,576	15%	\$389	\$134	\$339	\$163	\$61	CF	\$133	
QTR ROUND (QRD)												
VS1 24x24	\$2,553	\$2,808	\$2,936	15%	N/A	\$134	\$339	\$163	\$61	CF	\$133	
VS1 30x30	\$2,816	\$3,098	\$3,239	15%	N/A	\$134	\$339	\$163	\$61	CF	\$133	
VS1 36x36	\$3,145	\$3,459	\$3,617	15%	N/A	\$134	\$339	\$163	\$61	CF	\$133	
CRESCENT (CRT)												
VS1 24x24x48	\$3,144	\$3,459	\$3,616	15%	\$389	\$134	\$339	\$163	\$61	CF	\$133	
VS1 30x30x60	\$3,643	\$4,008	\$4,190	15%	\$389	\$134	\$339	\$163	\$61	CF	\$133	
VS1 36x36x72	\$4,175	\$4,592	\$4,801	15%	\$389	\$134	\$339	\$163	\$61	CF	\$133	

VS2 - VOYAGER TABLES - DOUBLE COLUMN END BASE (LAMINATE - PVC EDGE)



	Edge Choices: PVC & T-Mold				Laminate Upgrades		Light Weight	OPTIONS							
	T-15	L-21	P-14	PK-2	Laminate Upgrade I	Laminate Upgrade II	Light Weight (PVC only - 1" top)	NESTING	FOLDING	POWDERCOAT UPGRADE	CHROME	DELUXE CASTERS (BLK)	EQUALIZER GLIDES	ADJ. HEIGHT PIN	SPECIAL HEIGHT
	P-10 (self)	P-12		PK-4	ADD	ADD	ADD	ADD	ADD	ADD	ADD	ADD	ADD	ADD	ADD
ROUND (RND)															
VS2 54	\$1,762		\$1,850	\$1,938	\$132	\$352	\$308	N/A	\$424	\$99	\$542	\$163	\$61	N/A	\$228
VS2 60 (light weight std. folding)	\$1,907		\$2,003	\$2,098	\$143	\$381	\$334	N/A	\$758	\$99	\$542	\$163	\$61	N/A	\$228
RECTANGLE (REC)															
VS2 18x48	\$987		\$1,036	\$1,086	\$74	\$197	\$173	\$389	\$424	\$134	\$542	\$163	\$61	N/A	\$228
VS2 18x60	\$1,042		\$1,094	\$1,146	\$78	\$208	\$182	\$389	\$424	\$134	\$542	\$163	\$61	N/A	\$228
VS2 18x72	\$1,097		\$1,152	\$1,207	\$82	\$219	\$192	\$389	\$424	\$134	\$542	\$163	\$61	N/A	\$228
VS2 18x84	\$1,152		\$1,210	\$1,267	\$86	\$230	\$202	\$389	\$424	\$134	\$542	\$163	\$61	N/A	\$228
VS2 18x96	\$1,207		\$1,267	\$1,328	\$91	\$241	\$211	\$389	\$424	\$134	\$542	\$163	\$61	N/A	\$228
VS2 24x48	\$1,048		\$1,101	\$1,153	\$79	\$210	\$183	\$389	\$424	\$134	\$542	\$163	\$61	N/A	\$228
VS2 24x60	\$1,117		\$1,172	\$1,228	\$84	\$223	\$195	\$389	\$424	\$134	\$542	\$163	\$61	N/A	\$228
VS2 24x72	\$1,185		\$1,244	\$1,303	\$89	\$237	\$207	\$389	\$424	\$134	\$542	\$163	\$61	N/A	\$228
VS2 24x84	\$1,253		\$1,316	\$1,379	\$94	\$251	\$219	\$389	\$424	\$134	\$542	\$163	\$61	N/A	\$228
VS2 24x96	\$1,322		\$1,388	\$1,454	\$99	\$264	\$231	\$389	\$424	\$134	\$542	\$163	\$61	N/A	\$228
VS2 30x48	\$1,115		\$1,170	\$1,226	\$84	\$223	\$195	\$389	\$424	\$134	\$542	\$163	\$61	N/A	\$228
VS2 30x60	\$1,196		\$1,256	\$1,316	\$90	\$239	\$209	\$389	\$424	\$134	\$542	\$163	\$61	N/A	\$228
VS2 30x72	\$1,205		\$1,265	\$1,326	\$90	\$241	\$211	\$389	\$424	\$134	\$542	\$163	\$61	N/A	\$228
VS2 30x84	\$1,359		\$1,427	\$1,495	\$102	\$272	\$238	\$389	\$424	\$134	\$542	\$163	\$61	N/A	\$228
VS2 30x96	\$1,441		\$1,513	\$1,585	\$108	\$288	\$252	\$389	\$424	\$134	\$542	\$163	\$61	N/A	\$228
VS2 36x48	\$1,175		\$1,234	\$1,293	\$88	\$235	\$206	\$389	\$424	\$134	\$542	\$163	\$61	N/A	\$228
VS2 36x60	\$1,270		\$1,334	\$1,397	\$95	\$254	\$222	\$389	\$424	\$134	\$542	\$163	\$61	N/A	\$228
VS2 36x72	\$1,365		\$1,433	\$1,502	\$102	\$273	\$239	\$389	\$424	\$134	\$542	\$163	\$61	N/A	\$228
VS2 36x84	\$1,460		\$1,533	\$1,606	\$109	\$292	\$255	\$389	\$424	\$134	\$542	\$163	\$61	N/A	\$228
VS2 36x96	\$1,555		\$1,632	\$1,710	\$117	\$311	\$272	\$389	\$424	\$134	\$542	\$163	\$61	N/A	\$228
VS2 42x48	\$1,473		\$1,546	\$1,620	\$110	\$295	\$258	N/A	N/A	\$134	\$542	\$163	\$61	N/A	\$228
VS2 42x60	\$1,581		\$1,660	\$1,739	\$119	\$316	\$277	N/A	N/A	\$134	\$542	\$163	\$61	N/A	\$228
VS2 42x72	\$1,689		\$1,773	\$1,858	\$127	\$338	\$296	N/A	N/A	\$134	\$542	\$163	\$61	N/A	\$228
VS2 42x84	\$1,797		\$1,887	\$1,977	\$135	\$359	\$314	N/A	N/A	\$134	\$542	\$163	\$61	N/A	\$228
VS2 42x96	\$1,905		\$2,000	\$2,095	\$143	\$381	\$333	N/A	N/A	\$134	\$542	\$163	\$61	N/A	\$228
VS2 48x60	\$1,668		\$1,751	\$1,834	\$125	\$334	\$292	N/A	N/A	\$134	\$542	\$163	\$61	N/A	\$228
VS2 48x72	\$1,789		\$1,878	\$1,968	\$134	\$358	\$313	N/A	N/A	\$134	\$542	\$163	\$61	N/A	\$228
VS2 48x84	\$1,910		\$2,006	\$2,101	\$143	\$382	\$334	N/A	N/A	\$134	\$542	\$163	\$61	N/A	\$228
VS2 48x96	\$2,032		\$2,133	\$2,235	\$152	\$406	\$356	N/A	N/A	\$134	\$542	\$163	\$61	N/A	\$228
VS2 60x96	\$2,265		\$2,379	\$2,492	\$170	\$453	N/A	N/A	N/A	\$134	\$542	\$163	\$61	N/A	\$228

VS2 - VOYAGER TABLES - DOUBLE COLUMN END BASE (LAMINATE - PVC EDGE)



		Edge Choices: PVC & T-Mold				Laminate Upgrades		Light Weight	OPTIONS							
		T-15	L-21	P-14	PK-2	Laminate Upgrade I	Laminate Upgrade II	Light Weight (PVC only - 1" top)	NESTING	FOLDING	POWDERCOAT UPGRADE	CHROME	DELUXE CASTERS (BLK)	EQUALIZER GLIDES	ADJ. HEIGHT PIN	SPECIAL HEIGHT
		P-10 (self)	P-12		PK-4											
		L-15			L-23											
		ADD	ADD	ADD	ADD	ADD	ADD	ADD	ADD	ADD	ADD	ADD	ADD	ADD	ADD	ADD
RACETRACK (RAC)																
VS2	36x72	\$1,450	\$1,522	\$1,595	\$109	\$290	\$254	N/A	\$424	\$134	\$542	\$163	\$61	N/A	\$228	
VS2	36x84	\$1,545	\$1,622	\$1,699	\$116	\$309	\$270	N/A	\$424	\$134	\$542	\$163	\$61	N/A	\$228	
VS2	36x96	\$1,640	\$1,722	\$1,804	\$123	\$328	\$287	N/A	\$424	\$134	\$542	\$163	\$61	N/A	\$228	
VS2	42x96	\$2,095	\$2,199	\$2,304	\$157	\$419	\$367	N/A	N/A	\$134	\$542	\$163	\$61	N/A	\$228	
VS2	42x120 (1 piece)	\$2,774	\$2,913	\$3,052	\$208	\$555	N/A	N/A	N/A	\$134	\$542	\$244	\$91	N/A	\$228	
VS2	42x144 (1 piece)	\$3,002	\$3,152	\$3,302	\$225	\$600	N/A	N/A	N/A	\$134	\$542	\$244	\$91	N/A	\$228	
VS2	48x96	\$2,228	\$2,339	\$2,451	\$167	\$446	\$390	N/A	N/A	\$134	\$542	\$163	\$61	N/A	\$228	
VS2	48x120 (1 piece)	\$2,943	\$3,090	\$3,237	\$221	\$589	N/A	N/A	N/A	\$134	\$542	\$244	\$91	N/A	\$228	
VS2	48x144 (1 piece)	\$3,198	\$3,358	\$3,518	\$240	\$640	N/A	N/A	N/A	\$134	\$542	\$244	\$91	N/A	\$228	
VS2	60x96	\$2,937	\$3,083	\$3,230	\$220	\$587	N/A	N/A	N/A	\$134	\$542	\$163	\$61	N/A	\$228	
VS2	60x120 (1 piece)	\$3,248	\$3,410	\$3,573	\$244	\$650	N/A	N/A	N/A	\$134	\$542	\$244	\$91	N/A	\$228	
VS2	60x144 (1 piece)	\$3,559	\$3,737	\$3,915	\$267	\$979	N/A	N/A	N/A	\$134	\$542	\$244	\$91	N/A	\$228	
BOAT (BOT)																
VS2	36x48x96	\$2,228	\$2,339	\$2,451	\$167	\$446	\$390	N/A	N/A	\$134	\$542	\$163	\$61	N/A	\$228	
VS2	36x48x120 (1 piece)	\$2,943	\$3,090	\$3,237	\$221	\$589	N/A	N/A	N/A	\$134	\$542	\$244	\$91	N/A	\$228	
VS2	36x48x144 (1 piece)	\$3,198	\$3,358	\$3,518	\$240	\$640	N/A	N/A	N/A	\$134	\$542	\$244	\$91	N/A	\$228	
VS2	42x54x120 (1 piece)	\$3,100	\$3,255	\$3,410	\$233	\$620	N/A	N/A	N/A	\$134	\$542	\$244	\$91	N/A	\$228	
VS2	42x54x144 (1 piece)	\$3,384	\$3,553	\$3,722	\$254	\$677	N/A	N/A	N/A	\$134	\$542	\$244	\$91	N/A	\$228	
VS2	48x60x144 (1 piece)	\$3,559	\$3,737	\$3,915	\$267	\$712	N/A	N/A	N/A	\$134	\$542	\$244	\$91	N/A	\$228	
VS2	48x60x168 (2 pieces)	\$4,333	\$4,550	\$4,766	\$325	\$867	N/A	N/A	N/A	\$134	\$542	\$325	\$122	N/A	\$228	
VS2	48x60x192 (2 pieces)	\$4,644	\$4,876	\$5,109	\$348	\$929	N/A	N/A	N/A	\$134	\$542	\$325	\$122	N/A	\$228	
OVAL (OVL)																
VS2	36x60	\$1,355	\$1,423	\$1,491	\$102	\$271	\$237	N/A	N/A	\$134	\$542	\$163	\$61	N/A	\$228	
VS2	36x72	\$1,450	\$1,522	\$1,595	\$109	\$290	\$254	N/A	N/A	\$134	\$542	\$163	\$61	N/A	\$228	
VS2	36x84	\$1,545	\$1,622	\$1,699	\$116	\$309	\$270	N/A	N/A	\$134	\$542	\$163	\$61	N/A	\$228	
VS2	36x96	\$1,640	\$1,722	\$1,804	\$123	\$328	\$287	N/A	N/A	\$134	\$542	\$163	\$61	N/A	\$228	
VS2	42x72	\$1,774	\$1,862	\$1,951	\$133	\$355	\$310	N/A	N/A	\$134	\$542	\$163	\$61	N/A	\$228	
VS2	42x84	\$1,882	\$1,976	\$2,070	\$141	\$376	\$329	N/A	N/A	\$134	\$542	\$163	\$61	N/A	\$228	
VS2	42x96	\$1,990	\$2,089	\$2,189	\$149	\$398	\$348	N/A	N/A	\$134	\$542	\$163	\$61	N/A	\$228	
VS2	48x84	\$1,995	\$2,095	\$2,195	\$150	\$399	\$349	N/A	N/A	\$134	\$542	\$163	\$61	N/A	\$228	
VS2	48x96	\$2,117	\$2,222	\$2,328	\$159	\$423	\$370	N/A	N/A	\$134	\$542	\$163	\$61	N/A	\$228	
VS2	48x120 (1 piece)	\$2,483	\$2,608	\$2,732	\$186	\$497	N/A	N/A	N/A	\$134	\$542	\$244	\$91	N/A	\$228	
VS2	60x120 (1 piece)	\$2,785	\$2,925	\$3,064	\$209	\$557	N/A	N/A	N/A	\$134	\$542	\$244	\$91	N/A	\$228	

VS2 - VOYAGER TABLES - DOUBLE COLUMN END BASE (LAMINATE - PVC EDGE)



		Edge Choices: PVC & T-Mold				Laminate Upgrades		Light Weight	OPTIONS								
		T-15	L-21	P-14	PK-2	Laminate Upgrade I	Laminate Upgrade II	Light Weight (PVC only - 1" top)	NESTING	FOLDING	POWDERCOAT UPGRADE	CHROME	DELUXE CASTERS (BLK)	EQUALIZER GLIDES	ADJ. HEIGHT PIN	SPECIAL HEIGHT	
		P-10 (self)	P-12		PK-4												
		L-15			L-23												
						ADD	ADD	ADD	ADD	ADD	ADD	ADD	ADD	ADD	ADD	ADD	
TRAPEZOID (TRP)																	
VS2	24x24x48			\$1,132	\$1,189	\$1,246	\$85	\$226	\$198	CF	N/A	\$134	\$542	\$163	\$61	N/A	\$228
VS2	24x36x60			\$1,349	\$1,416	\$1,483	\$101	\$270	\$236	CF	N/A	\$134	\$542	\$163	\$61	N/A	\$228
VS2	30x30x60			\$1,275	\$1,339	\$1,403	\$96	\$255	\$223	CF	N/A	\$134	\$542	\$163	\$61	N/A	\$228
VS2	30x42x72			\$1,531	\$1,608	\$1,685	\$115	\$306	\$268	CF	N/A	\$134	\$542	\$163	\$61	N/A	\$228
VS2	36x36x72			\$1,450	\$1,522	\$1,595	\$109	\$290	\$254	CF	N/A	\$134	\$542	\$163	\$61	N/A	\$228
HALF ROUND (HRD)																	
VS2	24x48			\$1,077	\$1,131	\$1,185	\$81	\$215	\$188	CF	N/A	\$134	\$542	\$163	\$61	CF	\$228
VS2	30x60			\$1,217	\$1,277	\$1,338	\$91	\$243	\$213	CF	N/A	\$134	\$542	\$163	\$61	CF	\$228
VS2	36x72			\$1,388	\$1,457	\$1,527	\$104	\$278	\$243	CF	N/A	\$134	\$542	\$163	\$61	CF	\$228
QTR ROUND (QRD)																	
VS2	24x24			\$953	\$1,001	\$1,049	\$71	\$191	\$167	N/A	N/A	\$134	\$542	\$163	\$61	CF	\$228
VS2	30x30			\$1,029	\$1,080	\$1,132	\$77	\$206	\$180	N/A	N/A	\$134	\$542	\$163	\$61	CF	\$228
VS2	36x36			\$1,123	\$1,179	\$1,235	\$84	\$225	\$197	N/A	N/A	\$134	\$542	\$163	\$61	CF	\$228
CRESCENT (CRT)																	
VS2	24x24x48			\$1,133	\$1,190	\$1,247	\$85	\$227	\$198	CF	N/A	\$134	\$542	\$163	\$61	CF	\$228
VS2	30x30x60			\$1,281	\$1,345	\$1,409	\$96	\$256	\$224	CF	N/A	\$134	\$542	\$163	\$61	CF	\$228
VS2	36x36x72			\$1,450	\$1,522	\$1,595	\$109	\$290	\$254	CF	N/A	\$134	\$542	\$163	\$61	CF	\$228

VS2 - VOYAGER TABLES - DOUBLE COLUMN (LAMINATE - WOOD EDGE)



	Edge Choices: Wood (Red Oak & Maple)			Wood Upgrade	OPTIONS							
	W-12	W-23 W-18 W-16	W-19 W-17 W-32	Upgrade: Walnut/ Mahogany / Cherry	NESTING	FOLDING	POWDERCOAT UPGRADE	CHROME	DELUXE CASTERS (BLK)	EQUALIZER GLIDES	ADJ. HEIGHT PIN	SPECIAL HEIGHT
				ADD	ADD	ADD	ADD	ADD	ADD	ADD	ADD	ADD
ROUND (RND)												
VS2 54	\$3,304	\$3,965	\$4,406	15%	N/A	\$424	\$99	\$542	\$163	\$61	N/A	\$228
VS2 60 (light weight std. folding)	\$3,576	\$4,292	\$4,769	15%	N/A	\$424	\$99	\$542	\$163	\$61	N/A	\$228
RECTANGLE (REC)												
VS2 18x48	\$1,480	\$1,727	\$1,974	15%	\$389	\$424	\$134	\$542	\$163	\$61	N/A	\$228
VS2 18x60	\$1,563	\$1,823	\$2,084	15%	\$389	\$424	\$134	\$542	\$163	\$61	N/A	\$228
VS2 18x72	\$1,645	\$1,920	\$2,194	15%	\$389	\$424	\$134	\$542	\$163	\$61	N/A	\$228
VS2 18x84	\$1,811	\$2,112	\$2,414	15%	\$389	\$424	\$134	\$542	\$163	\$61	N/A	\$228
VS2 18x96	\$1,811	\$2,112	\$2,414	15%	\$389	\$424	\$134	\$542	\$163	\$61	N/A	\$228
VS2 24x48	\$1,572	\$1,834	\$2,097	15%	\$389	\$424	\$134	\$542	\$163	\$61	N/A	\$228
VS2 24x60	\$1,675	\$1,954	\$2,233	15%	\$389	\$424	\$134	\$542	\$163	\$61	N/A	\$228
VS2 24x72	\$1,777	\$2,074	\$2,370	15%	\$389	\$424	\$134	\$542	\$163	\$61	N/A	\$228
VS2 24x84	\$1,982	\$2,313	\$2,643	15%	\$389	\$424	\$134	\$542	\$163	\$61	N/A	\$228
VS2 24x96	\$1,982	\$2,313	\$2,643	15%	\$389	\$424	\$134	\$542	\$163	\$61	N/A	\$228
VS2 30x48	\$1,672	\$1,951	\$2,229	15%	\$389	\$424	\$134	\$542	\$163	\$61	N/A	\$228
VS2 30x60	\$1,794	\$2,093	\$2,393	15%	\$389	\$424	\$134	\$542	\$163	\$61	N/A	\$228
VS2 30x72	\$1,808	\$2,109	\$2,410	15%	\$389	\$424	\$134	\$542	\$163	\$61	N/A	\$228
VS2 30x84	\$2,161	\$2,522	\$2,882	15%	\$389	\$424	\$134	\$542	\$163	\$61	N/A	\$228
VS2 30x96	\$2,161	\$2,522	\$2,882	15%	\$389	\$424	\$134	\$542	\$163	\$61	N/A	\$228
VS2 36x48	\$1,763	\$2,057	\$2,351	15%	\$389	\$424	\$134	\$542	\$163	\$61	N/A	\$228
VS2 36x60	\$1,905	\$2,223	\$2,540	15%	\$389	\$424	\$134	\$542	\$163	\$61	N/A	\$228
VS2 36x72	\$2,048	\$2,389	\$2,730	15%	\$389	\$424	\$134	\$542	\$163	\$61	N/A	\$228
VS2 36x84	\$2,332	\$2,721	\$3,109	15%	\$389	\$424	\$134	\$542	\$163	\$61	N/A	\$228
VS2 36x96	\$2,332	\$2,721	\$3,109	15%	\$389	\$424	\$134	\$542	\$163	\$61	N/A	\$228
VS2 42x48	\$2,761	\$3,313	\$3,681	15%	N/A	N/A	\$134	\$542	\$163	\$61	N/A	\$228
VS2 42x60	\$2,964	\$3,557	\$3,952	15%	N/A	N/A	\$134	\$542	\$163	\$61	N/A	\$228
VS2 42x72	\$3,201	\$3,841	\$4,268	15%	N/A	N/A	\$134	\$542	\$163	\$61	N/A	\$228
VS2 42x84	\$3,457	\$4,148	\$4,609	15%	N/A	N/A	\$134	\$542	\$163	\$61	N/A	\$228
VS2 42x96	\$3,734	\$4,480	\$4,978	15%	N/A	N/A	\$134	\$542	\$163	\$61	N/A	\$228
VS2 48x60	\$3,127	\$3,752	\$4,169	15%	N/A	N/A	\$134	\$542	\$163	\$61	N/A	\$228
VS2 48x72	\$3,354	\$4,025	\$4,472	15%	N/A	N/A	\$134	\$542	\$163	\$61	N/A	\$228
VS2 48x84	\$3,809	\$4,571	\$5,079	15%	N/A	N/A	\$134	\$542	\$163	\$61	N/A	\$228
VS2 48x96	\$3,809	\$4,571	\$5,079	15%	N/A	N/A	\$134	\$542	\$163	\$61	N/A	\$228
VS2 60x96	\$4,248	\$5,097	\$5,664	15%	N/A	N/A	\$134	\$542	\$163	\$61	N/A	\$228

VS2 - VOYAGER TABLES - DOUBLE COLUMN (LAMINATE - WOOD EDGE)



	Edge Choices: Wood (Red Oak & Maple)			Wood Upgrade	OPTIONS								
	W-12	W-23 W-18 W-16	W-19 W-17 W-32	Upgrade: Walnut/ Mahogany / Cherry	NESTING	FOLDING	POWDERCOAT UPGRADE	CHROME	DELUXE CASTERS (BLK)	EQUALIZER GLIDES	ADJ. HEIGHT PIN	SPECIAL HEIGHT	
				ADD	ADD	ADD	ADD	ADD	ADD	ADD	ADD	ADD	
RACETRACK (RAC)													
VS2 36x72	\$2,175	\$2,537	\$2,900	15%	N/A	\$424	\$134	\$542	\$163	\$61	N/A	\$228	
VS2 36x84	\$2,459	\$2,869	\$3,279	15%	N/A	\$424	\$134	\$542	\$163	\$61	N/A	\$228	
VS2 36x96	\$2,459	\$2,869	\$3,279	15%	N/A	\$424	\$134	\$542	\$163	\$61	N/A	\$228	
VS2 42x96	\$2,951	\$3,443	\$3,935	15%	N/A	N/A	\$134	\$542	\$163	\$61	N/A	\$228	
VS2 42x120 (1 piece)	\$3,542	\$4,132	\$4,722	15%	N/A	N/A	\$134	\$542	\$244	\$91	N/A	\$228	
VS2 42x144 (1 piece)	\$4,250	\$4,958	\$5,667	15%	N/A	N/A	\$134	\$542	\$244	\$91	N/A	\$228	
VS2 48x96	\$4,177	\$5,013	\$5,570	15%	N/A	N/A	\$134	\$542	\$163	\$61	N/A	\$228	
VS2 48x120 (1 piece)	\$5,517	\$6,621	\$7,356	15%	N/A	N/A	\$134	\$542	\$244	\$91	N/A	\$228	
VS2 48x144 (1 piece)	\$5,996	\$7,196	\$7,995	15%	N/A	N/A	\$134	\$542	\$244	\$91	N/A	\$228	
VS2 60x96	\$5,506	\$6,607	\$7,341	15%	N/A	N/A	\$134	\$542	\$163	\$61	N/A	\$228	
VS2 60x120 (1 piece)	\$6,090	\$7,308	\$8,120	15%	N/A	N/A	\$134	\$542	\$244	\$91	N/A	\$228	
VS2 60x144 (1 piece)	\$6,673	\$8,008	\$8,898	15%	N/A	N/A	\$134	\$542	\$244	\$91	N/A	\$228	
BOAT (BOT)													
VS2 36x48x96	\$3,342	\$3,899	\$4,456	15%	N/A	N/A	\$134	\$542	\$163	\$61	N/A	\$228	
VS2 36x48x120 (1 piece)	\$4,414	\$5,150	\$5,885	15%	N/A	N/A	\$134	\$542	\$244	\$91	N/A	\$228	
VS2 36x48x144 (1 piece)	\$5,297	\$6,179	\$7,062	15%	N/A	N/A	\$134	\$542	\$244	\$91	N/A	\$228	
VS2 42x54x120 (1 piece)	\$6,356	\$7,415	\$8,475	15%	N/A	N/A	\$134	\$542	\$244	\$91	N/A	\$228	
VS2 42x54x144 (1 piece)	\$7,627	\$8,898	\$10,170	15%	N/A	N/A	\$134	\$542	\$244	\$91	N/A	\$228	
VS2 48x60x144 (1 piece)	\$6,673	\$8,008	\$8,898	15%	N/A	N/A	\$134	\$542	\$244	\$91	N/A	\$228	
VS2 48x60x168 (2 pieces)	\$8,124	\$9,749	\$10,832	15%	N/A	N/A	\$134	\$542	\$325	\$122	N/A	\$228	
VS2 48x60x192 (2 pieces)	\$8,708	\$10,450	\$11,611	15%	N/A	N/A	\$134	\$542	\$325	\$122	N/A	\$228	
OVAL (OVL)													
VS2 36x60	\$2,175	\$2,537	\$2,900	15%	N/A	N/A	\$134	\$542	\$163	\$61	N/A	\$228	
VS2 36x72	\$2,175	\$2,537	\$2,900	15%	N/A	N/A	\$134	\$542	\$163	\$61	N/A	\$228	
VS2 36x84	\$2,459	\$2,869	\$3,279	15%	N/A	N/A	\$134	\$542	\$163	\$61	N/A	\$228	
VS2 36x96	\$2,459	\$2,869	\$3,279	15%	N/A	N/A	\$134	\$542	\$163	\$61	N/A	\$228	
VS2 42x72	\$2,951	\$3,443	\$3,935	15%	N/A	N/A	\$134	\$542	\$163	\$61	N/A	\$228	
VS2 42x84	\$3,542	\$4,132	\$4,722	15%	N/A	N/A	\$134	\$542	\$163	\$61	N/A	\$228	
VS2 42x96	\$4,250	\$4,958	\$5,667	15%	N/A	N/A	\$134	\$542	\$163	\$61	N/A	\$228	
VS2 48x84	\$3,969	\$4,762	\$5,291	15%	N/A	N/A	\$134	\$542	\$163	\$61	N/A	\$228	
VS2 48x96	\$3,969	\$4,762	\$5,291	15%	N/A	N/A	\$134	\$542	\$163	\$61	N/A	\$228	
VS2 48x120 (1 piece)	\$4,657	\$5,588	\$6,209	15%	N/A	N/A	\$134	\$542	\$244	\$91	N/A	\$228	
VS2 60x120 (1 piece)	\$5,223	\$6,267	\$6,963	15%	N/A	N/A	\$134	\$542	\$244	\$91	N/A	\$228	

VS2 - VOYAGER TABLES - DOUBLE COLUMN (LAMINATE - WOOD EDGE)



		Edge Choices: Wood (Red Oak & Maple)			Wood Upgrade	OPTIONS							
		W-12	W-23	W-19	Upgrade: Walnut/ Mahogany / Cherry	NESTING	FOLDING	POWDERCOAT UPGRADE	CHROME	DELUXE CASTERS (BLK)	EQUALIZER GLIDES	ADJ. HEIGHT PIN	SPECIAL HEIGHT
		W-18	W-17	ADD									
		W-16	W-32										
TRAPEZOID (TRP)													
VS2	24x24x48	\$1,982	\$2,299	\$2,636	15%	CF	N/A	\$134	\$542	\$163	\$61	N/A	\$228
VS2	24x36x60	\$2,360	\$2,738	\$3,139	15%	CF	N/A	\$134	\$542	\$163	\$61	N/A	\$228
VS2	30x30x60	\$2,232	\$2,589	\$2,969	15%	CF	N/A	\$134	\$542	\$163	\$61	N/A	\$228
VS2	30x42x72	\$2,680	\$3,109	\$3,564	15%	CF	N/A	\$134	\$542	\$163	\$61	N/A	\$228
VS2	36x36x72	\$2,537	\$2,943	\$3,375	15%	CF	N/A	\$134	\$542	\$163	\$61	N/A	\$228
HALF ROUND (HRD)													
VS2	24x48	\$1,884	\$2,186	\$2,506	15%	CF	N/A	\$134	\$542	\$163	\$61	CF	\$228
VS2	30x60	\$2,129	\$2,470	\$2,832	15%	CF	N/A	\$134	\$542	\$163	\$61	CF	\$228
VS2	36x72	\$2,429	\$2,817	\$3,230	15%	CF	N/A	\$134	\$542	\$163	\$61	CF	\$228
QTR ROUND (QRD)													
VS2	24x24	\$1,668	\$1,935	\$2,219	15%	N/A	N/A	\$134	\$542	\$163	\$61	CF	\$228
VS2	30x30	\$1,801	\$2,089	\$2,395	15%	N/A	N/A	\$134	\$542	\$163	\$61	CF	\$228
VS2	36x36	\$1,965	\$2,280	\$2,614	15%	N/A	N/A	\$134	\$542	\$163	\$61	CF	\$228
CRESCENT (CRT)													
VS2	24x24x48	\$1,983	\$2,300	\$2,637	15%	CF	N/A	\$134	\$542	\$163	\$61	CF	\$228
VS2	30x30x60	\$2,242	\$2,601	\$2,982	15%	CF	N/A	\$134	\$542	\$163	\$61	CF	\$228
VS2	36x36x72	\$2,537	\$2,943	\$3,375	15%	CF	N/A	\$134	\$542	\$163	\$61	CF	\$228

VS2 - VOYAGER TABLES - DOUBLE COLUMN END BASE (VENEER)



	Edge Choices: Wood (Red Oak & Maple)			Wood Upgrade	OPTIONS							
	V-12	V-23 V-18 V-16	V-19 V-17 V-32	Upgrade: Walnut / Mahogany / Cherry	NESTING	POWDERCOAT UPGRADE	CHROME	DELUXE CASTERS (BLN)	EQUALIZER GLIDES	ADJ. HEIGHT PIN	SPECIAL HEIGHT	
				ADD	ADD	ADD	ADD	ADD	ADD	ADD	ADD	
ROUND (RND)												
VS2 54	\$4,406	\$4,846	\$5,066	15%	N/A	\$99	\$542	\$163	\$61	N/A	\$228	
VS2 60 (light weight std. folding)	\$5,341	\$5,875	\$6,142	15%	N/A	\$99	\$542	\$163	\$61	N/A	\$228	
RECTANGLE (REC)												
VS2 18x48	\$1,974	\$2,171	\$2,270	15%	\$389	\$134	\$542	\$163	\$61	N/A	\$228	
VS2 18x60	\$2,084	\$2,292	\$2,396	15%	\$389	\$134	\$542	\$163	\$61	N/A	\$228	
VS2 18x72	\$2,194	\$2,413	\$2,523	15%	\$389	\$134	\$542	\$163	\$61	N/A	\$228	
VS2 18x84	\$2,414	\$2,656	\$2,776	15%	\$389	\$134	\$542	\$163	\$61	N/A	\$228	
VS2 18x96	\$2,414	\$2,656	\$2,776	15%	\$389	\$134	\$542	\$163	\$61	N/A	\$228	
VS2 24x48	\$2,097	\$2,306	\$2,411	15%	\$389	\$134	\$542	\$163	\$61	N/A	\$228	
VS2 24x60	\$2,233	\$2,457	\$2,568	15%	\$389	\$134	\$542	\$163	\$61	N/A	\$228	
VS2 24x72	\$2,370	\$2,607	\$2,725	15%	\$389	\$134	\$542	\$163	\$61	N/A	\$228	
VS2 24x84	\$2,643	\$2,907	\$3,040	15%	\$389	\$134	\$542	\$163	\$61	N/A	\$228	
VS2 24x96	\$2,643	\$2,907	\$3,040	15%	\$389	\$134	\$542	\$163	\$61	N/A	\$228	
VS2 30x48	\$2,229	\$2,452	\$2,564	15%	\$389	\$134	\$542	\$163	\$61	N/A	\$228	
VS2 30x60	\$2,393	\$2,632	\$2,751	15%	\$389	\$134	\$542	\$163	\$61	N/A	\$228	
VS2 30x72	\$2,410	\$2,651	\$2,772	15%	\$389	\$134	\$542	\$163	\$61	N/A	\$228	
VS2 30x84	\$2,882	\$3,170	\$3,314	15%	\$389	\$134	\$542	\$163	\$61	N/A	\$228	
VS2 30x96	\$2,882	\$3,170	\$3,314	15%	\$389	\$134	\$542	\$163	\$61	N/A	\$228	
VS2 36x48	\$2,351	\$2,586	\$2,703	15%	\$389	\$134	\$542	\$163	\$61	N/A	\$228	
VS2 36x60	\$2,540	\$2,794	\$2,921	15%	\$389	\$134	\$542	\$163	\$61	N/A	\$228	
VS2 36x72	\$2,730	\$3,003	\$3,140	15%	\$389	\$134	\$542	\$163	\$61	N/A	\$228	
VS2 36x84	\$3,109	\$3,420	\$3,576	15%	\$389	\$134	\$542	\$163	\$61	N/A	\$228	
VS2 36x96	\$3,109	\$3,420	\$3,576	15%	\$389	\$134	\$542	\$163	\$61	N/A	\$228	
VS2 42x48	\$2,945	\$3,240	\$3,387	15%	N/A	\$134	\$542	\$163	\$61	N/A	\$228	
VS2 42x60	\$3,161	\$3,477	\$3,636	15%	N/A	\$134	\$542	\$163	\$61	N/A	\$228	
VS2 42x72	\$3,414	\$3,756	\$3,926	15%	N/A	\$134	\$542	\$163	\$61	N/A	\$228	
VS2 42x84	\$3,687	\$4,056	\$4,241	15%	N/A	\$134	\$542	\$163	\$61	N/A	\$228	
VS2 42x96	\$3,982	\$4,381	\$4,580	15%	N/A	\$134	\$542	\$163	\$61	N/A	\$228	
VS2 48x60	\$3,335	\$3,669	\$3,835	15%	N/A	\$134	\$542	\$163	\$61	N/A	\$228	
VS2 48x72	\$3,578	\$3,936	\$4,115	15%	N/A	\$134	\$542	\$163	\$61	N/A	\$228	
VS2 48x84	\$4,063	\$4,470	\$4,673	15%	N/A	\$134	\$542	\$163	\$61	N/A	\$228	
VS2 48x96	\$4,063	\$4,470	\$4,673	15%	N/A	\$134	\$542	\$163	\$61	N/A	\$228	
VS2 60x96	\$4,531	\$4,984	\$5,211	15%	N/A	\$134	\$542	\$163	\$61	N/A	\$228	

VS2 - VOYAGER TABLES - DOUBLE COLUMN END BASE (VENEER)



	Edge Choices: Wood (Red Oak & Maple)			Wood Upgrade	OPTIONS							
	V-12	V-23 V-18 V-16	V-19 V-17 V-32	Upgrade: Walnut / Mahogany / Cherry	NESTING	POWDERCOAT UPGRADE	CHROME	DELUXE CASTERS (BLN)	EQUALIZER GLIDES	ADJ. HEIGHT PIN	SPECIAL HEIGHT	
				ADD	ADD	ADD	ADD	ADD	ADD	ADD	ADD	
RACETRACK (RAC)												
VS2 36x72	\$2,900	\$3,190	\$3,335	15%	N/A	\$134	\$542	\$163	\$61	N/A	\$228	
VS2 36x84	\$3,279	\$3,607	\$3,771	15%	N/A	\$134	\$542	\$163	\$61	N/A	\$228	
VS2 36x96	\$3,279	\$3,607	\$3,771	15%	N/A	\$134	\$542	\$163	\$61	N/A	\$228	
VS2 42x96	\$3,935	\$4,329	\$4,525	15%	N/A	\$134	\$542	\$163	\$61	N/A	\$228	
VS2 42x120 (1 piece)	\$4,722	\$5,194	\$5,430	15%	N/A	\$134	\$542	\$244	\$91	N/A	\$228	
VS2 42x144 (1 piece)	\$5,667	\$6,233	\$6,517	15%	N/A	\$134	\$542	\$244	\$91	N/A	\$228	
VS2 48x96	\$4,456	\$4,902	\$5,124	15%	N/A	\$134	\$542	\$163	\$61	N/A	\$228	
VS2 48x120 (1 piece)	\$5,885	\$6,474	\$6,768	15%	N/A	\$134	\$542	\$244	\$91	N/A	\$228	
VS2 48x144 (1 piece)	\$6,396	\$7,036	\$7,356	15%	N/A	\$134	\$542	\$244	\$91	N/A	\$228	
VS2 60x96	\$5,873	\$6,460	\$6,754	15%	N/A	\$134	\$542	\$163	\$61	N/A	\$228	
VS2 60x120 (1 piece)	\$6,496	\$7,145	\$7,470	15%	N/A	\$134	\$542	\$244	\$91	N/A	\$228	
VS2 60x144 (1 piece)	\$7,118	\$7,830	\$8,186	15%	N/A	\$134	\$542	\$244	\$91	N/A	\$228	
BOAT (BOT)												
VS2 36x48x96	\$4,456	\$4,902	\$5,124	15%	N/A	\$134	\$542	\$163	\$61	N/A	\$228	
VS2 36x48x120 (1 piece)	\$5,885	\$6,474	\$6,768	15%	N/A	\$134	\$542	\$244	\$91	N/A	\$228	
VS2 36x48x144 (1 piece)	\$7,062	\$7,768	\$8,122	15%	N/A	\$134	\$542	\$244	\$91	N/A	\$228	
VS2 42x54x120 (1 piece)	\$8,475	\$9,322	\$9,746	15%	N/A	\$134	\$542	\$244	\$91	N/A	\$228	
VS2 42x54x144 (1 piece)	\$10,170	\$11,187	\$11,695	15%	N/A	\$134	\$542	\$244	\$91	N/A	\$228	
VS2 48x60x144 (1 piece)	\$7,118	\$7,830	\$8,186	15%	N/A	\$134	\$542	\$244	\$91	N/A	\$228	
VS2 48x60x168 (2 pieces)	\$8,666	\$9,533	\$9,966	15%	N/A	\$134	\$542	\$325	\$122	N/A	\$228	
VS2 48x60x192 (2 pieces)	\$9,289	\$10,217	\$10,682	15%	N/A	\$134	\$542	\$325	\$122	N/A	\$228	
OVAL (OVL)												
VS2 36x60	\$2,900	\$3,190	\$3,335	15%	N/A	\$134	\$542	\$163	\$61	N/A	\$228	
VS2 36x72	\$2,900	\$3,190	\$3,335	15%	N/A	\$134	\$542	\$163	\$61	N/A	\$228	
VS2 36x84	\$3,279	\$3,607	\$3,771	15%	N/A	\$134	\$542	\$163	\$61	N/A	\$228	
VS2 36x96	\$3,279	\$3,607	\$3,771	15%	N/A	\$134	\$542	\$163	\$61	N/A	\$228	
VS2 42x72	\$3,935	\$4,329	\$4,525	15%	N/A	\$134	\$542	\$163	\$61	N/A	\$228	
VS2 42x84	\$4,722	\$5,194	\$5,430	15%	N/A	\$134	\$542	\$163	\$61	N/A	\$228	
VS2 42x96	\$5,667	\$6,233	\$6,517	15%	N/A	\$134	\$542	\$163	\$61	N/A	\$228	
VS2 48x84	\$4,233	\$4,656	\$4,868	15%	N/A	\$134	\$542	\$163	\$61	N/A	\$228	
VS2 48x96	\$4,233	\$4,656	\$4,868	15%	N/A	\$134	\$542	\$163	\$61	N/A	\$228	
VS2 48x120 (1 piece)	\$4,967	\$5,464	\$5,712	15%	N/A	\$134	\$542	\$244	\$91	N/A	\$228	
VS2 60x120 (1 piece)	\$5,571	\$6,128	\$6,406	15%	N/A	\$134	\$542	\$244	\$91	N/A	\$228	

VS2 - VOYAGER TABLES - DOUBLE COLUMN END BASE (VENEER)



Edge Choices: Wood (Red Oak & Maple)				Wood Upgrade	OPTIONS							
V-12	V-23	V-19		Upgrade: Walnut / Mahogany / Cherry	NESTING	POWDERCOAT UPGRADE	CHROME	DELUXE CASTERS (BLN)	EQUALIZER GLIDES	ADJ. HEIGHT PIN	SPECIAL HEIGHT	
	V-18	V-17		ADD	ADD	ADD	ADD	ADD	ADD	ADD	ADD	
	V-16	V-32										
TRAPEZOID (TRP)												
VS2 24x24x48	\$2,636	\$2,899	\$3,031	15%	CF	\$134	\$542	\$163	\$61	N/A	\$228	
VS2 24x36x60	\$3,139	\$3,453	\$3,610	15%	CF	\$134	\$542	\$163	\$61	N/A	\$228	
VS2 30x30x60	\$2,969	\$3,265	\$3,414	15%	CF	\$134	\$542	\$163	\$61	N/A	\$228	
VS2 30x42x72	\$3,564	\$3,921	\$4,099	15%	CF	\$134	\$542	\$163	\$61	N/A	\$228	
VS2 36x36x72	\$3,375	\$3,712	\$3,881	15%	CF	\$134	\$542	\$163	\$61	N/A	\$228	
HALF ROUND (HRD)												
VS2 24x48	\$2,506	\$2,757	\$2,882	15%	CF	\$134	\$542	\$163	\$61	CF	\$228	
VS2 30x60	\$2,832	\$3,115	\$3,256	15%	CF	\$134	\$542	\$163	\$61	CF	\$228	
VS2 36x72	\$3,230	\$3,553	\$3,715	15%	CF	\$134	\$542	\$163	\$61	CF	\$228	
QTR ROUND (QRD)												
VS2 24x24	\$2,219	\$2,441	\$2,552	15%	N/A	\$134	\$542	\$163	\$61	CF	\$228	
VS2 30x30	\$2,395	\$2,635	\$2,754	15%	N/A	\$134	\$542	\$163	\$61	CF	\$228	
VS2 36x36	\$2,614	\$2,875	\$3,006	15%	N/A	\$134	\$542	\$163	\$61	CF	\$228	
CRESCENT (CRT)												
VS2 24x24x48	\$2,637	\$2,901	\$3,033	15%	CF	\$134	\$542	\$163	\$61	CF	\$228	
VS2 30x30x60	\$2,982	\$3,280	\$3,429	15%	CF	\$134	\$542	\$163	\$61	CF	\$228	
VS2 36x36x72	\$3,375	\$3,712	\$3,881	15%	CF	\$134	\$542	\$163	\$61	CF	\$228	

VOYAGER PREMIUM SOLID STEEL

Voyager Premium Solid Steel tables were developed to offer you Quality and Styling. Bases of the pedestal are made of Solid Steel to allow the ultimate in base foundation with unparalleled durability.

TABLE PEDESTAL SPECIFICATIONS

Finishes: Available in 40+ standard powder coat finishes. Chrome plated finishes are offered at an additional charge. Our unique mechanical construction enables a flawless seam when mixing column finishes with any base finish. Custom finishes available. Please contact Customer Service for quotation.

Glides and Casters: All tables are equipped with 1" diameter stainless steel, rubber cushioned glides with 1/2" long stem fully threaded into solid steel base. Optional styles of glides and casters available at an additional charge.

Voyager Premium Solid Steel Pedestals

Base constructed of 2" diameter solid steel, fully MIG welded for maximum support. Smaller pedestals equipped with powder coated 10" locking cast spider; larger pedestals equipped with 15" cast spider, machined for column recess to insure levelness. 2" diameter (14 gauge) and 3" diameter (16 gauge) columns constructed from welded tubing. Factory assembled with 1/2"-13 threaded steel rod and flange nut at 60 ft/lb torque. Square ends on all bases.

Voyager Premium Solid Steel Pedestals compliment our Voyager Folding Tables and Titan single folding leg.

Voyager Premium Solid Steel Table Options

There are several options available on Voyager Premium Solid Steel including:

- Nesting
- Flip Top
- Special Height
- Center Mount Electrical Column

VOYAGER PREMIUM SOLID STEEL

VOYAGER PREMIUM SOLID STEEL BASE SPECIFICATIONS

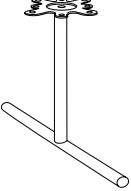
<u>Single Column End Base</u>	<u>Smart Code</u>	<u>Base Size</u>	<u>Column Diameter</u>	<u>Top Capacity</u>
	VS1BAR-16EB	16"	2"	18"x96"
	VS1BAR-20EB	20"	2"	24"x96"
	VS1BAR-26EB	26"	2"	30" & 36"x96"
	VS1BAR-36EB	36"	2"	42"x96"

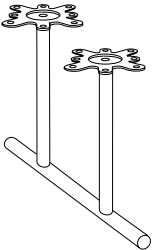
<u>Double Column End Base</u>	<u>Smart Code</u>	<u>Base Size</u>	<u>Column Diameter</u>	<u>Top Capacity</u>
	VS2BAR-36EB	36"	2"	48"x96"
	VS2BAR-42EB	42"	2"	60"x96"

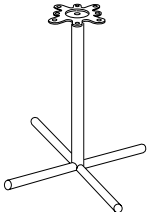
<u>Cross Base</u>	<u>Smart Code</u>	<u>Base Size</u>	<u>Column Diameter</u>	<u>Top Capacity</u>
	VSXBAR-20	20"	3"	30" SQ & RND
	VSXABAR-26	26"	3"	42" SQ & RND
	VSXBAR-30	30"	3"	48" SQ & 54" RND
	VSXBAR-36	36"	3"	48" SQ & 60" RND
	VSXBAR-36-5	36" x 5	2" & 3"	60" SQ & 72" RND
	VSXBAR-2026	20"x26"	3"	30"x36"
	VSXBAR-2630	26"x30"	3"	36"x42"
	VSXBAR-2636	26"x36"	3"	36"x48"

VS BAR - VOYAGER TABLES - PREMIUM SOLID STEEL (LAMINATE - PVC EDGE)



		Edge Choices: PVC & T-Mold				Laminate Upgrades		Light Weight	OPTIONS							
		T-15	L-21	P-14	PK-2	Laminate Upgrade I	Laminate Upgrade II	Light Weight (PVC only - 1" top)	NESTING	FLIP TOP	POWDERCOAT UPGRADE	CHROME	DELUXE CASTERS (BLK)	EQUALIZER GLIDES	CENTER MOUNT ELEC. COLUMN	SPECIAL HEIGHT
		P-10 (self)	P-12		PK-4	ADD	ADD	ADD	ADD	ADD	ADD	ADD	ADD	ADD	ADD	ADD
		L-15			L-23											
SQUARE (SQR)																
VSXBAR	24x24	\$1,262	\$1,325	\$1,388	\$95	\$252	\$221	N/A	\$112	\$134	\$271	\$163	\$61	\$338	\$80	
VSXBAR	30x30	\$1,341	\$1,408	\$1,475	\$101	\$268	\$235	N/A	\$112	\$134	\$271	\$163	\$61	\$338	\$80	
VSXBAR	36x36	\$1,540	\$1,617	\$1,694	\$116	\$308	\$270	N/A	\$112	\$134	\$271	\$163	\$61	\$338	\$80	
VSXBAR	42x42	\$1,793	\$1,883	\$1,972	\$134	\$359	\$314	N/A	\$112	\$134	\$271	\$163	\$61	\$338	\$80	
VSXBAR	48x48	\$1,914	\$2,009	\$2,105	\$144	\$383	\$335	N/A	N/A	\$134	\$271	\$163	\$61	N/A	\$80	
ROUND (RND)																
VSXBAR	24	\$1,293	\$1,357	\$1,422	\$97	\$259	\$226	N/A	\$112	\$134	\$271	\$163	\$61	\$338	\$80	
VSXBAR	30	\$1,368	\$1,437	\$1,505	\$103	\$274	\$239	N/A	\$112	\$134	\$271	\$163	\$61	\$338	\$80	
VSXBAR	36	\$1,564	\$1,642	\$1,720	\$117	\$313	\$274	N/A	\$112	\$134	\$271	\$163	\$61	\$338	\$80	
VSXBAR	42	\$1,667	\$1,751	\$1,834	\$125	\$333	\$292	N/A	\$112	\$134	\$271	\$163	\$61	\$338	\$80	
VSXBAR	48	\$1,931	\$2,027	\$2,124	\$145	\$386	\$338	N/A	\$112	\$134	\$271	\$163	\$61	\$338	\$80	
VSXBAR	54	\$2,062	\$2,165	\$2,268	\$155	\$412	\$361	N/A	N/A	\$134	\$271	\$163	\$61	N/A	\$80	
VSXBAR	60	\$2,277	\$2,391	\$2,505	\$171	\$455	\$399	N/A	N/A	\$134	\$271	\$163	\$61	N/A	\$80	
VSXBAR	72 (2 piece)	\$3,627	\$3,809	\$3,990	\$272	\$725	\$635	N/A	N/A	\$134	\$271	\$163	\$61	N/A	\$80	
RECTANGLE (REC)																
VS1BAR	18x48	\$1,284	\$1,348	\$1,412	\$96	\$257	\$225	\$389	N/A	\$134	\$339	\$163	\$61	N/A	\$133	
VS1BAR	18x60	\$1,342	\$1,409	\$1,476	\$101	\$268	\$235	\$389	N/A	\$134	\$339	\$163	\$61	N/A	\$133	
VS1BAR	18x72	\$1,400	\$1,470	\$1,540	\$105	\$280	\$245	\$389	N/A	\$134	\$339	\$163	\$61	N/A	\$133	
VS1BAR	18x84	\$1,458	\$1,531	\$1,604	\$109	\$292	\$255	\$389	N/A	\$134	\$339	\$163	\$61	N/A	\$133	
VS1BAR	18x96	\$1,516	\$1,591	\$1,667	\$114	\$303	\$265	\$389	N/A	\$134	\$339	\$163	\$61	N/A	\$133	
VSXBAR20	24x30	\$1,278	\$1,342	\$1,406	\$96	\$256	\$224	N/A	\$112	\$134	\$271	\$163	\$61	\$338	\$80	
VSXBAR20	24x36	\$1,314	\$1,379	\$1,445	\$99	\$263	\$230	N/A	\$112	\$134	\$271	\$163	\$61	\$338	\$80	
VS1BAR	24x48	\$1,407	\$1,478	\$1,548	\$106	\$281	\$246	\$389	N/A	\$134	\$339	\$163	\$61	N/A	\$133	
VS1BAR	24x60	\$1,479	\$1,553	\$1,627	\$111	\$296	\$259	\$389	N/A	\$134	\$339	\$163	\$61	N/A	\$133	
VS1BAR	24x72	\$1,551	\$1,629	\$1,706	\$116	\$310	\$271	\$389	N/A	\$134	\$339	\$163	\$61	N/A	\$133	
VS1BAR	24x84	\$1,623	\$1,704	\$1,785	\$122	\$325	\$284	\$389	N/A	\$134	\$339	\$163	\$61	N/A	\$133	
VS1BAR	24x96	\$1,695	\$1,780	\$1,864	\$127	\$339	\$297	\$389	N/A	\$134	\$339	\$163	\$61	N/A	\$133	
VS1BAR	24x120 (1 piece)	\$2,316	\$2,431	\$2,547	\$174	\$463	N/A	N/A	N/A	\$134	\$339	\$244	\$91	N/A	\$133	
VS1BAR	24x144 (1 piece)	\$2,459	\$2,582	\$2,705	\$184	\$492	N/A	N/A	N/A	\$134	\$339	\$244	\$91	N/A	\$133	
VSXBAR26	30x42	\$1,644	\$1,726	\$1,809	\$123	\$329	\$288	N/A	\$112	\$134	\$271	\$163	\$61	\$338	\$80	
VSXBAR26	30x48	\$1,733	\$1,820	\$1,907	\$130	\$347	\$303	N/A	\$112	\$134	\$271	\$163	\$61	N/A	\$80	
VS1BAR	30x48	\$1,547	\$1,625	\$1,702	\$116	\$309	\$271	\$389	N/A	\$134	\$339	\$163	\$61	N/A	\$133	
VS1BAR	30x60	\$1,633	\$1,715	\$1,797	\$122	\$327	\$286	\$389	N/A	\$134	\$339	\$163	\$61	N/A	\$133	
VS1BAR	30x72	\$1,643	\$1,725	\$1,807	\$123	\$329	\$287	\$389	N/A	\$134	\$339	\$163	\$61	N/A	\$133	
VS1BAR	30x84	\$1,805	\$1,895	\$1,986	\$135	\$361	\$316	\$389	N/A	\$134	\$339	\$163	\$61	N/A	\$133	
VS1BAR	30x96	\$1,891	\$1,985	\$2,080	\$142	\$378	\$331	\$389	N/A	\$134	\$339	\$163	\$61	N/A	\$133	
VS1BAR	30x120 (1 piece)	\$2,063	\$2,166	\$2,269	\$155	\$413	N/A	N/A	N/A	\$134	\$339	\$244	\$91	N/A	\$133	
VS1BAR	30x144 (1 piece)	\$2,234	\$2,346	\$2,458	\$168	\$447	N/A	N/A	N/A	\$134	\$339	\$244	\$91	N/A	\$133	
VSXBAR26	36x42	\$1,747	\$1,835	\$1,922	\$131	\$349	\$306	N/A	\$112	\$134	\$271	\$163	\$61	\$338	\$80	
VSXBAR26	36x48	\$1,797	\$1,887	\$1,977	\$135	\$359	\$315	N/A	\$112	\$134	\$271	\$163	\$61	N/A	\$80	
VS1BAR	36x48	\$1,611	\$1,692	\$1,772	\$121	\$322	\$282	\$389	N/A	\$134	\$339	\$163	\$61	N/A	\$133	
VS1BAR	36x60	\$1,711	\$1,797	\$1,882	\$128	\$342	\$299	\$389	N/A	\$134	\$339	\$163	\$61	N/A	\$133	
VS1BAR	36x72	\$1,811	\$1,902	\$1,992	\$136	\$362	\$317	\$389	N/A	\$134	\$339	\$163	\$61	N/A	\$133	

VS BAR - VOYAGER TABLES - PREMIUM SOLID STEEL (LAMINATE - PVC EDGE)



	Edge Choices: PVC & T-Mold				Laminate Upgrades		Light Weight (PVC only - 1" top)	OPTIONS							
	T-15	L-21	P-14	PK-2	Laminate Upgrade I	Laminate Upgrade II		NESTING	FLIP TOP	POWDERCOAT UPGRADE	CHROME	DELUXE CASTERS (BLK)	EQUALIZER GLIDES	CENTER MOUNT ELEC. COLUMN	SPECIAL HEIGHT
	P-10 (self)	P-12		PK-4	ADD	ADD	ADD	ADD	ADD	ADD	ADD	ADD	ADD	ADD	
	L-15			L-23											
VS1BAR 36x84					\$143	\$382	\$334	\$389	N/A	\$134	\$339	\$163	\$61	N/A	\$133
VS1BAR 36x96					\$151	\$402	\$352	\$389	N/A	\$134	\$339	\$163	\$61	N/A	\$133
VS1BAR 36x120 (1 piece)					\$166	\$442	N/A	N/A	N/A	\$134	\$339	\$244	\$91	N/A	\$133
VS1BAR 36x144 (1 piece)					\$181	\$482	N/A	N/A	N/A	\$134	\$339	\$244	\$91	N/A	\$133
VS1BAR 42x48					\$135	\$359	\$314	N/A	N/A	\$134	\$339	\$163	\$61	N/A	\$133
VS1BAR 42x60					\$143	\$382	\$334	N/A	N/A	\$134	\$339	\$163	\$61	N/A	\$133
VS1BAR 42x72					\$152	\$404	\$354	N/A	N/A	\$134	\$339	\$163	\$61	N/A	\$133
VS1BAR 42x84					\$160	\$427	\$374	N/A	N/A	\$134	\$339	\$163	\$61	N/A	\$133
VS1BAR 42x96					\$169	\$450	\$394	N/A	N/A	\$134	\$339	\$163	\$61	N/A	\$133
VS1BAR 42x120 (1 piece)					\$186	\$495	\$433	N/A	N/A	\$134	\$339	\$163	\$61	N/A	\$133
VS1BAR 42x144 (1 piece)					\$203	\$541	\$473	N/A	N/A	\$134	\$339	\$163	\$61	N/A	\$133
VS2BAR 48x60					\$171	\$456	\$399	N/A	N/A	\$134	\$542	\$163	\$61	N/A	\$228
VS2BAR 48x72					\$181	\$482	\$422	N/A	N/A	\$134	\$542	\$163	\$61	N/A	\$228
VS2BAR 48x84					\$190	\$508	\$444	N/A	N/A	\$134	\$542	\$163	\$61	N/A	\$228
VS2BAR 48x96					\$200	\$533	\$466	N/A	N/A	\$134	\$542	\$163	\$61	N/A	\$228
VS2BAR 48x120 (1 piece)					\$219	\$584	N/A	N/A	N/A	\$134	\$542	\$244	\$91	N/A	\$228
VS2BAR 48x144 (1 piece)					\$238	\$635	N/A	N/A	N/A	\$134	\$542	\$244	\$91	N/A	\$228
VS2BAR 60x96					\$225	\$599	N/A	N/A	N/A	\$134	\$542	\$163	\$61	N/A	\$228
VS2BAR 60x120 (1 piece)					\$248	\$661	N/A	N/A	N/A	\$134	\$542	\$244	\$91	N/A	\$228
VS2BAR 60x144 (1 piece)					\$271	\$723	N/A	N/A	N/A	\$134	\$542	\$244	\$91	N/A	\$228
RACETRACK (RAC)															
VS1BAR 36x72					\$143	\$380	\$333	\$389	N/A	\$134	\$339	\$163	\$61	N/A	\$133
VS1BAR 36x84					\$150	\$400	\$350	\$389	N/A	\$134	\$339	\$163	\$61	N/A	\$133
VS1BAR 36x96					\$158	\$420	\$368	\$389	N/A	\$134	\$339	\$163	\$61	N/A	\$133
VS1BAR 36x120 (1 piece)					\$172	\$460	N/A	N/A	N/A	\$134	\$339	\$244	\$91	N/A	\$133
VS1BAR 36x144 (1 piece)					\$187	\$500	N/A	N/A	N/A	\$134	\$339	\$244	\$91	N/A	\$133
VS1BAR 42x96					\$175	\$468	\$409	N/A	N/A	\$134	\$339	\$163	\$61	N/A	\$133
VS1BAR 42x120 (1 piece)					\$192	\$513	N/A	N/A	N/A	\$134	\$339	\$244	\$91	N/A	\$133
VS1BAR 42x144 (1 piece)					\$210	\$559	N/A	N/A	N/A	\$134	\$339	\$244	\$91	N/A	\$133
VS2BAR 48x96					\$207	\$551	\$482	N/A	N/A	\$134	\$542	\$163	\$61	N/A	\$228
VS2BAR 48x120 (1 piece)					\$226	\$602	N/A	N/A	N/A	\$134	\$542	\$244	\$91	N/A	\$228
VS2BAR 48x144 (1 piece)					\$245	\$653	N/A	N/A	N/A	\$134	\$542	\$244	\$91	N/A	\$228
VS2BAR 60x96					\$231	\$617	N/A	N/A	N/A	\$134	\$542	\$163	\$61	N/A	\$228
VS2BAR 60x120 (1 piece)					\$255	\$679	N/A	N/A	N/A	\$134	\$542	\$244	\$91	N/A	\$228
VS2BAR 60x144 (1 piece)					\$278	\$741	N/A	N/A	N/A	\$134	\$542	\$244	\$91	N/A	\$228
BOAT (BOT)															
VS1BAR 36x48x96					\$184	\$492	\$430	N/A	N/A	\$134	\$339	\$163	\$61	N/A	\$133
VS1BAR 36x48x120 (1 piece)					\$204	\$543	N/A	N/A	N/A	\$134	\$339	\$244	\$91	N/A	\$133
VS1BAR 36x48x144 (1 piece)					\$223	\$594	N/A	N/A	N/A	\$134	\$339	\$244	\$91	N/A	\$133
VS2BAR 42x54x120 (1 piece)					\$244	\$649	N/A	N/A	N/A	\$134	\$542	\$244	\$91	N/A	\$228
VS2BAR 42x54x144 (1 piece)					\$265	\$706	N/A	N/A	N/A	\$134	\$542	\$244	\$91	N/A	\$228
VS2BAR 48x60x144 (1 piece)					\$278	\$741	N/A	N/A	N/A	\$134	\$542	\$244	\$91	N/A	\$228
OVAL (OVL)															
VS1BAR 36x60					\$135	\$360	\$315	\$389	N/A	\$134	\$339	\$163	\$61	N/A	\$133



VS BAR - VOYAGER TABLES - PREMIUM SOLID STEEL (LAMINATE - PVC EDGE)



		Edge Choices: PVC & T-Mold				Laminate Upgrades		Light Weight	OPTIONS							
		T-15	L-21	P-14	PK-2	Laminate Upgrade I	Laminate Upgrade II	Light Weight (PVC only - 1" top)	NESTING	FLIP TOP	POWDERCOAT UPGRADE	CHROME	DELUXE CASTERS (BLK)	EQUALIZER GLIDES	CENTER MOUNT ELEC. COLUMN	SPECIAL HEIGHT
		P-10 (self)	P-12		PK-4	ADD	ADD	ADD	ADD	ADD	ADD	ADD	ADD	ADD	ADD	ADD
		L-15			L-23											
VS1BAR	36x72	\$1,900		\$1,995	\$2,090	\$143	\$380	\$333	\$389	N/A	\$134	\$339	\$163	\$61	N/A	\$133
VS1BAR	36x84	\$2,000		\$2,100	\$2,200	\$150	\$400	\$350	\$389	N/A	\$134	\$339	\$163	\$61	N/A	\$133
VS1BAR	36x96	\$2,100		\$2,205	\$2,310	\$158	\$420	\$368	\$389	N/A	\$134	\$339	\$163	\$61	N/A	\$133
VS1BAR	42x72	\$2,111		\$2,216	\$2,322	\$158	\$422	\$369	N/A	N/A	\$134	\$339	\$163	\$61	N/A	\$133
VS1BAR	42x84	\$2,225		\$2,336	\$2,447	\$167	\$445	\$389	N/A	N/A	\$134	\$339	\$163	\$61	N/A	\$133
VS1BAR	42x96	\$2,338		\$2,455	\$2,572	\$175	\$468	\$409	N/A	N/A	\$134	\$339	\$163	\$61	N/A	\$133
VS2BAR	48x84	\$2,627		\$2,758	\$2,890	\$197	\$525	\$460	N/A	N/A	\$134	\$542	\$163	\$61	N/A	\$228
VS2BAR	48x96	\$2,755		\$2,892	\$3,030	\$207	\$551	\$482	N/A	N/A	\$134	\$542	\$163	\$61	N/A	\$228
VS2BAR	48x120 (1 piece)	\$3,010		\$3,161	\$3,311	\$226	\$602	N/A	N/A	N/A	\$134	\$542	\$244	\$91	N/A	\$228
VS2BAR	48x144 (1 piece)	\$3,266		\$3,429	\$3,592	\$245	\$653	N/A	N/A	N/A	\$134	\$542	\$244	\$91	N/A	\$228
VS2BAR	60x120 (1 piece)	\$3,395		\$3,565	\$3,734	\$255	\$679	N/A	N/A	N/A	\$134	\$542	\$163	\$61	N/A	\$228
VS2BAR	60x144 (1 piece)	\$3,706		\$3,891	\$4,077	\$278	\$741	N/A	N/A	N/A	\$134	\$542	\$244	\$91	N/A	\$228
TRAPEZOID (TRP)																
VS1BAR	24x24x48	\$1,437		\$1,509	\$1,581	\$108	\$287	\$251	\$389	N/A	\$134	\$339	\$163	\$61	N/A	\$133
VS1BAR	24x36x60	\$1,665		\$1,748	\$1,831	\$125	\$333	\$291	\$389	N/A	\$134	\$339	\$163	\$61	N/A	\$133
VS1BAR	30x30x60	\$1,646		\$1,729	\$1,811	\$123	\$329	\$288	\$389	N/A	\$134	\$339	\$163	\$61	N/A	\$133
VS1BAR	30x42x72	\$1,916		\$2,012	\$2,107	\$144	\$383	\$335	\$389	N/A	\$134	\$339	\$163	\$61	N/A	\$133
VS1BAR	36x36x72	\$1,900		\$1,995	\$2,090	\$143	\$380	\$333	\$389	N/A	\$134	\$339	\$163	\$61	N/A	\$133
HALF ROUND (HRD)																
VS1BAR	24x48	\$1,379		\$1,448	\$1,516	\$103	\$276	\$241	\$389	N/A	\$134	\$339	\$163	\$61	N/A	\$133
VS1BAR	30x60	\$1,584		\$1,664	\$1,743	\$119	\$317	\$277	\$389	N/A	\$134	\$339	\$163	\$61	N/A	\$133
VS1BAR	36x72	\$1,835		\$1,927	\$2,018	\$138	\$367	\$321	\$389	N/A	\$134	\$339	\$163	\$61	N/A	\$133
QTR ROUND (QRD)																
VS1BAR	24x24	\$1,249		\$1,311	\$1,373	\$94	\$250	\$219	N/A	N/A	\$134	\$339	\$163	\$61	N/A	\$133
VS1BAR	30x30	\$1,387		\$1,456	\$1,526	\$104	\$277	\$243	N/A	N/A	\$134	\$339	\$163	\$61	N/A	\$133
VS1BAR	36x36	\$1,556		\$1,634	\$1,712	\$117	\$311	\$272	N/A	N/A	\$134	\$339	\$163	\$61	N/A	\$133
CRESCENT (CRT)																
VS1BAR	24x24x48	\$1,497		\$1,572	\$1,646	\$112	\$299	\$262	\$389	N/A	\$134	\$339	\$163	\$61	N/A	\$133
VS1BAR	30x30x60	\$1,723		\$1,809	\$1,895	\$129	\$345	\$301	\$389	N/A	\$134	\$339	\$163	\$61	N/A	\$133
VS1BAR	36x36x72	\$1,900		\$1,995	\$2,090	\$143	\$380	\$333	\$389	N/A	\$134	\$339	\$163	\$61	N/A	\$133



VS BAR - VOYAGER TABLES - PREMIUM SOLID STEEL (LAMINATE - WOOD EDGE)



		Edge Choices: Wood (Red Oak & Maple)			Wood Upgrade	OPTIONS							
					Upgrade: Walnut/ Mahogany / Cherry	NESTING	FLIP TOP	POWDERCOAT UPGRADE	CHROME	DELUXE CASTERS (BLK)	EQUALIZER GLIDES	CENTER MOUNT ELEC. COLUMN	SPECIAL HEIGHT
		W-12	W-23	W-19									
SQUARE (SQR)													
VSXBAR	24x24	\$1,893	\$2,208	\$2,524	15%	N/A	\$112	\$134	\$271	\$163	\$61	\$338	\$80
VSXBAR	30x30	\$2,011	\$2,347	\$2,682	15%	N/A	\$112	\$134	\$271	\$163	\$61	\$338	\$80
VSXBAR	36x36	\$2,310	\$2,695	\$3,080	15%	N/A	\$112	\$134	\$271	\$163	\$61	\$338	\$80
VSXBAR	42x42	\$3,362	\$4,034	\$4,483	15%	N/A	\$112	\$134	\$271	\$163	\$61	\$338	\$80
VSXBAR	48x48	\$3,588	\$4,306	\$4,785	15%	N/A	N/A	\$134	\$271	\$163	\$61	N/A	\$80
ROUND (RND)													
VSXBAR	24	\$1,939	\$2,262	\$2,586	15%	N/A	\$112	\$134	\$271	\$163	\$61	\$338	\$80
VSXBAR	30	\$2,052	\$2,394	\$2,737	15%	N/A	\$112	\$134	\$271	\$163	\$61	\$338	\$80
VSXBAR	36	\$2,346	\$2,737	\$3,128	15%	N/A	\$112	\$134	\$271	\$163	\$61	\$338	\$80
VSXBAR	42	\$3,126	\$3,752	\$4,168	15%	N/A	\$112	\$134	\$271	\$163	\$61	\$338	\$80
VSXBAR	48	\$3,620	\$4,344	\$4,827	15%	N/A	\$112	\$134	\$271	\$163	\$61	\$338	\$80
VSXBAR	54	\$3,866	\$4,640	\$5,155	15%	N/A	N/A	\$134	\$271	\$163	\$61	N/A	\$80
VSXBAR	60	\$4,270	\$5,124	\$5,693	15%	N/A	N/A	\$134	\$271	\$163	\$61	N/A	\$80
VSXBAR	72 (2 piece)	\$6,801	\$8,162	\$9,068	15%	N/A	N/A	\$134	\$271	\$163	\$61	N/A	\$80
RECTANGLE (REC)													
VS1BAR	18x48	\$1,926	\$2,247	\$2,568	15%	\$389	N/A	\$134	\$339	\$163	\$61	N/A	\$133
VS1BAR	18x60	\$2,013	\$2,348	\$2,684	15%	\$389	N/A	\$134	\$339	\$163	\$61	N/A	\$133
VS1BAR	18x72	\$2,100	\$2,450	\$2,800	15%	\$389	N/A	\$134	\$339	\$163	\$61	N/A	\$133
VS1BAR	18x84	\$2,274	\$2,652	\$3,031	15%	\$389	N/A	\$134	\$339	\$163	\$61	N/A	\$133
VS1BAR	18x96	\$2,274	\$2,652	\$3,031	15%	\$389	N/A	\$134	\$339	\$163	\$61	N/A	\$133
VSXBAR20	24x30	\$1,917	\$2,236	\$2,556	15%	N/A	\$112	\$134	\$271	\$163	\$61	\$338	\$80
VSXBAR20	24x36	\$1,971	\$2,299	\$2,628	15%	N/A	\$112	\$134	\$271	\$163	\$61	\$338	\$80
VS1BAR	24x48	\$2,111	\$2,463	\$2,815	15%	\$389	N/A	\$134	\$339	\$163	\$61	N/A	\$133
VS1BAR	24x60	\$2,219	\$2,589	\$2,958	15%	\$389	N/A	\$134	\$339	\$163	\$61	N/A	\$133
VS1BAR	24x72	\$2,327	\$2,714	\$3,102	15%	\$389	N/A	\$134	\$339	\$163	\$61	N/A	\$133
VS1BAR	24x84	\$2,542	\$2,966	\$3,390	15%	\$389	N/A	\$134	\$339	\$163	\$61	N/A	\$133
VS1BAR	24x96	\$2,542	\$2,966	\$3,390	15%	\$389	N/A	\$134	\$339	\$163	\$61	N/A	\$133
VS1BAR	24x120 (1 piece)	\$3,473	\$4,029	\$4,619	15%	N/A	N/A	\$134	\$339	\$244	\$91	N/A	\$133
VS1BAR	24x144 (1 piece)	\$3,689	\$4,279	\$4,906	15%	N/A	N/A	\$134	\$339	\$244	\$91	N/A	\$133
VSXBAR26	30x42	\$2,466	\$2,877	\$3,288	15%	N/A	\$112	\$134	\$271	\$163	\$61	\$338	\$80
VSXBAR26	30x48	\$2,600	\$3,033	\$3,467	15%	N/A	\$112	\$134	\$271	\$163	\$61	N/A	\$80
VS1BAR	30x48	\$2,321	\$2,708	\$3,095	15%	\$389	N/A	\$134	\$339	\$163	\$61	N/A	\$133
VS1BAR	30x60	\$2,450	\$2,858	\$3,267	15%	\$389	N/A	\$134	\$339	\$163	\$61	N/A	\$133
VS1BAR	30x72	\$2,464	\$2,875	\$3,285	15%	\$389	N/A	\$134	\$339	\$163	\$61	N/A	\$133
VS1BAR	30x84	\$2,836	\$3,309	\$3,782	15%	\$389	N/A	\$134	\$339	\$163	\$61	N/A	\$133
VS1BAR	30x96	\$2,836	\$3,309	\$3,782	15%	\$389	N/A	\$134	\$339	\$163	\$61	N/A	\$133
VS1BAR	30x120 (1 piece)	\$3,094	\$3,589	\$4,115	15%	N/A	N/A	\$134	\$339	\$244	\$91	N/A	\$133
VS1BAR	30x144 (1 piece)	\$3,352	\$3,888	\$4,458	15%	N/A	N/A	\$134	\$339	\$244	\$91	N/A	\$133
VSXBAR26	36x42	\$2,621	\$3,058	\$3,495	15%	N/A	\$112	\$134	\$271	\$163	\$61	\$338	\$80
VSXBAR26	36x48	\$2,696	\$3,145	\$3,594	15%	N/A	\$112	\$134	\$271	\$163	\$61	N/A	\$80
VS1BAR	36x48	\$2,417	\$2,820	\$3,223	15%	\$389	N/A	\$134	\$339	\$163	\$61	N/A	\$133
VS1BAR	36x60	\$2,567	\$2,995	\$3,422	15%	\$389	N/A	\$134	\$339	\$163	\$61	N/A	\$133
VS1BAR	36x72	\$2,716	\$3,169	\$3,622	15%	\$389	N/A	\$134	\$339	\$163	\$61	N/A	\$133







VS BAR - VOYAGER TABLES - PREMIUM SOLID STEEL (LAMINATE - WOOD EDGE)



		Edge Choices: Wood (Red Oak & Maple)			Wood Upgrade	OPTIONS							
					Upgrade: Walnut / Mahogany / Cherry	NESTING	FLIP TOP	POWDERCOAT UPGRADE	CHROME	DELUXE CASTERS (BLK)	EQUALIZER GLIDES	CENTER MOUNT ELEC. COLUMN	SPECIAL HEIGHT
		W-12	W-23	W-19									
VS1BAR	36x84	\$3,016	\$3,519	\$4,021	15%	\$389	N/A	\$134	\$339	\$163	\$61	N/A	\$133
VS1BAR	36x96	\$3,016	\$3,519	\$4,021	15%	\$389	N/A	\$134	\$339	\$163	\$61	N/A	\$133
VS1BAR	36x120 (1 piece)	\$3,315	\$3,868	\$4,421	15%	N/A	N/A	\$134	\$339	\$244	\$91	N/A	\$133
VS1BAR	36x144 (1 piece)	\$3,615	\$4,193	\$4,808	15%	N/A	N/A	\$134	\$339	\$244	\$91	N/A	\$133
VS1BAR	42x48	\$3,363	\$4,036	\$4,484	15%	N/A	N/A	\$134	\$339	\$163	\$61	N/A	\$133
VS1BAR	42x60	\$3,577	\$4,292	\$4,769	15%	N/A	N/A	\$134	\$339	\$163	\$61	N/A	\$133
VS1BAR	42x72	\$3,032	\$3,517	\$4,033	15%	N/A	N/A	\$134	\$339	\$163	\$61	N/A	\$133
VS1BAR	42x84	\$3,203	\$3,715	\$4,260	15%	N/A	N/A	\$134	\$339	\$163	\$61	N/A	\$133
VS1BAR	42x96	\$3,373	\$3,913	\$4,487	15%	N/A	N/A	\$134	\$339	\$163	\$61	N/A	\$133
VS1BAR	42x120 (1 piece)	\$3,715	\$4,309	\$4,941	15%	N/A	N/A	\$134	\$339	\$163	\$61	N/A	\$133
VS1BAR	42x144 (1 piece)	\$4,056	\$4,705	\$5,395	15%	N/A	N/A	\$134	\$339	\$163	\$61	N/A	\$133
VS2BAR	48x60	\$4,279	\$5,135	\$5,705	15%	N/A	N/A	\$134	\$542	\$163	\$61	N/A	\$228
VS2BAR	48x72	\$4,519	\$5,422	\$6,025	15%	N/A	N/A	\$134	\$542	\$163	\$61	N/A	\$228
VS2BAR	48x84	\$4,998	\$5,997	\$6,663	15%	N/A	N/A	\$134	\$542	\$163	\$61	N/A	\$228
VS2BAR	48x96	\$4,998	\$5,997	\$6,663	15%	N/A	N/A	\$134	\$542	\$163	\$61	N/A	\$228
VS2BAR	48x120 (1 piece)	\$5,477	\$6,572	\$7,302	15%	N/A	N/A	\$134	\$542	\$244	\$91	N/A	\$228
VS2BAR	48x144 (1 piece)	\$5,956	\$7,147	\$7,941	15%	N/A	N/A	\$134	\$542	\$244	\$91	N/A	\$228
VS2BAR	60x96	\$5,614	\$6,737	\$7,485	15%	N/A	N/A	\$134	\$542	\$163	\$61	N/A	\$228
VS2BAR	60x120 (1 piece)	\$6,198	\$7,437	\$8,264	15%	N/A	N/A	\$134	\$542	\$244	\$91	N/A	\$228
VS2BAR	60x144 (1 piece)	\$6,781	\$8,138	\$9,042	15%	N/A	N/A	\$134	\$542	\$244	\$91	N/A	\$228
RACETRACK (RAC)													
VS1BAR	36x72	\$2,851	\$3,326	\$3,801	15%	\$389	N/A	\$134	\$339	\$163	\$61	N/A	\$133
VS1BAR	36x84	\$3,150	\$3,675	\$4,200	15%	\$389	N/A	\$134	\$339	\$163	\$61	N/A	\$133
VS1BAR	36x96	\$3,150	\$3,675	\$4,200	15%	\$389	N/A	\$134	\$339	\$163	\$61	N/A	\$133
VS1BAR	36x120 (1 piece)	\$3,450	\$4,024	\$4,599	15%	N/A	N/A	\$134	\$339	\$244	\$91	N/A	\$133
VS1BAR	36x144 (1 piece)	\$3,749	\$4,349	\$4,986	15%	N/A	N/A	\$134	\$339	\$244	\$91	N/A	\$133
VS1BAR	42x96	\$3,507	\$4,069	\$4,665	15%	N/A	N/A	\$134	\$339	\$163	\$61	N/A	\$133
VS1BAR	42x120 (1 piece)	\$3,849	\$4,465	\$5,119	15%	N/A	N/A	\$134	\$339	\$244	\$91	N/A	\$133
VS1BAR	42x144 (1 piece)	\$4,190	\$4,861	\$5,573	15%	N/A	N/A	\$134	\$339	\$244	\$91	N/A	\$133
VS2BAR	48x96	\$5,165	\$6,198	\$6,887	15%	N/A	N/A	\$134	\$542	\$163	\$61	N/A	\$228
VS2BAR	48x120 (1 piece)	\$5,644	\$6,773	\$7,526	15%	N/A	N/A	\$134	\$542	\$244	\$91	N/A	\$228
VS2BAR	48x144 (1 piece)	\$6,123	\$7,348	\$8,164	15%	N/A	N/A	\$134	\$542	\$244	\$91	N/A	\$228
VS2BAR	60x96	\$5,782	\$6,938	\$7,709	15%	N/A	N/A	\$134	\$542	\$163	\$61	N/A	\$228
VS2BAR	60x120 (1 piece)	\$6,365	\$7,638	\$8,487	15%	N/A	N/A	\$134	\$542	\$244	\$91	N/A	\$228
VS2BAR	60x144 (1 piece)	\$6,949	\$8,339	\$9,265	15%	N/A	N/A	\$134	\$542	\$244	\$91	N/A	\$228
BOAT (BOT)													
VS1BAR	36x48x96	\$3,687	\$4,302	\$4,916	15%	N/A	N/A	\$134	\$339	\$163	\$61	N/A	\$133
VS1BAR	36x48x120 (1 piece)	\$4,070	\$4,749	\$5,427	15%	N/A	N/A	\$134	\$339	\$244	\$91	N/A	\$133
VS1BAR	36x48x144 (1 piece)	\$4,453	\$5,166	\$5,923	15%	N/A	N/A	\$134	\$339	\$244	\$91	N/A	\$133
VS2BAR	42x54x120 (1 piece)	\$4,871	\$5,650	\$6,478	15%	N/A	N/A	\$134	\$542	\$244	\$91	N/A	\$228
VS2BAR	42x54x144 (1 piece)	\$5,296	\$6,143	\$7,044	15%	N/A	N/A	\$134	\$542	\$244	\$91	N/A	\$228
VS2BAR	48x60x144 (1 piece)	\$6,949	\$8,339	\$9,265	15%	N/A	N/A	\$134	\$542	\$244	\$91	N/A	\$228
OVAL (OVL)													
VS1BAR	36x60	\$2,851	\$3,326	\$3,801	15%	\$389	N/A	\$134	\$339	\$163	\$61	N/A	\$133

VS BAR - VOYAGER TABLES - PREMIUM SOLID STEEL (LAMINATE - WOOD EDGE)



		Edge Choices: Wood (Red Oak & Maple)			Wood Upgrade	OPTIONS							
		 W-12	 W-23	 W-19	Upgrade: Walnut / Mahogany / Cherry	NESTING	FLIP TOP	POWDERCOAT UPGRADE	CHROME	DELUXE CASTERS (BLK)	EQUALIZER GLIDES	CENTER MOUNT ELEC. COLUMN	SPECIAL HEIGHT
			 W-18	 W-17	ADD	ADD	ADD	ADD	ADD	ADD	ADD	ADD	ADD
			 W-16	 W-32									
VS1BAR	36x72	\$2,851	\$3,326	\$3,801	15%	\$389	N/A	\$134	\$339	\$163	\$61	N/A	\$133
VS1BAR	36x84	\$3,150	\$3,675	\$4,200	15%	\$389	N/A	\$134	\$339	\$163	\$61	N/A	\$133
VS1BAR	36x96	\$3,150	\$3,675	\$4,200	15%	\$389	N/A	\$134	\$339	\$163	\$61	N/A	\$133
VS1BAR	42x72	\$3,166	\$3,673	\$4,211	15%	N/A	N/A	\$134	\$339	\$163	\$61	N/A	\$133
VS1BAR	42x84	\$3,337	\$3,871	\$4,438	15%	N/A	N/A	\$134	\$339	\$163	\$61	N/A	\$133
VS1BAR	42x96	\$3,507	\$4,069	\$4,665	15%	N/A	N/A	\$134	\$339	\$163	\$61	N/A	\$133
VS2BAR	48x84	\$3,941	\$4,571	\$5,241	15%	N/A	N/A	\$134	\$542	\$163	\$61	N/A	\$228
VS2BAR	48x96	\$5,165	\$6,198	\$6,887	15%	N/A	N/A	\$134	\$542	\$163	\$61	N/A	\$228
VS2BAR	48x120 (1 piece)	\$5,644	\$6,773	\$7,526	15%	N/A	N/A	\$134	\$542	\$244	\$91	N/A	\$228
VS2BAR	48x144 (1 piece)	\$6,123	\$7,348	\$8,164	15%	N/A	N/A	\$134	\$542	\$244	\$91	N/A	\$228
VS2BAR	60x120 (1 piece)	\$6,365	\$7,638	\$8,487	15%	N/A	N/A	\$134	\$542	\$163	\$61	N/A	\$228
VS2BAR	60x144 (1 piece)	\$6,949	\$8,339	\$9,265	15%	N/A	N/A	\$134	\$542	\$244	\$91	N/A	\$228
TRAPEZOID (TRP)													
VS1BAR	24x24x48	\$2,156	\$2,501	\$2,867	15%	\$389	N/A	\$134	\$339	\$163	\$61	N/A	\$133
VS1BAR	24x36x60	\$2,497	\$2,897	\$3,321	15%	\$389	N/A	\$134	\$339	\$163	\$61	N/A	\$133
VS1BAR	30x30x60	\$2,470	\$2,865	\$3,285	15%	\$389	N/A	\$134	\$339	\$163	\$61	N/A	\$133
VS1BAR	30x42x72	\$2,874	\$3,334	\$3,822	15%	\$389	N/A	\$134	\$339	\$163	\$61	N/A	\$133
VS1BAR	36x36x72	\$2,851	\$3,307	\$3,791	15%	\$389	N/A	\$134	\$339	\$163	\$61	N/A	\$133
HALF ROUND (HRD)													
VS1BAR	24x48	\$2,068	\$2,399	\$2,750	15%	\$389	N/A	\$134	\$339	\$163	\$61	N/A	\$133
VS1BAR	30x60	\$2,377	\$2,757	\$3,161	15%	\$389	N/A	\$134	\$339	\$163	\$61	N/A	\$133
VS1BAR	36x72	\$2,752	\$3,193	\$3,661	15%	\$389	N/A	\$134	\$339	\$163	\$61	N/A	\$133
QTR ROUND (QRD)													
VS1BAR	24x24	\$1,873	\$2,173	\$2,491	15%	N/A	N/A	\$134	\$339	\$163	\$61	N/A	\$133
VS1BAR	30x30	\$2,081	\$2,413	\$2,767	15%	N/A	N/A	\$134	\$339	\$163	\$61	N/A	\$133
VS1BAR	36x36	\$2,334	\$2,708	\$3,105	15%	N/A	N/A	\$134	\$339	\$163	\$61	N/A	\$133
CRESCENT (CRT)													
VS1BAR	24x24x48	\$2,245	\$2,604	\$2,986	15%	\$389	N/A	\$134	\$339	\$163	\$61	N/A	\$133
VS1BAR	30x30x60	\$2,584	\$2,998	\$3,437	15%	\$389	N/A	\$134	\$339	\$163	\$61	N/A	\$133
VS1BAR	36x36x72	\$2,851	\$3,307	\$3,791	15%	\$389	N/A	\$134	\$339	\$163	\$61	N/A	\$133

VS BAR - VOYAGER TABLES - PREMIUM SOLID STEEL (VENEER)



		Edge Choices: Wood (Red Oak & Maple)			Wood Upgrade	OPTIONS							
		V-12	V-23	V-19	Upgrade: Walnut / Mahogany / Cherry	NESTING	FLIP TOP	POWDERCOAT UPGRADE	CHROME	DELUXE CASTERS (BLK)	EQUALIZER GLIDES	CENTER MOUNT ELEC. COLUMN	SPECIAL HEIGHT
			V-18	V-17	ADD	ADD	ADD	ADD	ADD	ADD	ADD	ADD	ADD
			V-16	V-32									
SQUARE (SQR)													
VSXBAR	24x24	\$2,055	\$2,261	\$2,363	15%	N/A	\$112	\$134	\$271	\$163	\$61	\$338	\$80
VSXBAR	30x30	\$2,470	\$2,717	\$2,840	15%	N/A	\$112	\$134	\$271	\$163	\$61	\$338	\$80
VSXBAR	36x36	\$3,011	\$3,312	\$3,463	15%	N/A	\$112	\$134	\$271	\$163	\$61	\$338	\$80
VSXBAR	42x42	\$3,790	\$4,169	\$4,359	15%	N/A	\$112	\$134	\$271	\$163	\$61	\$338	\$80
VSXBAR	48x48	\$4,475	\$4,922	\$5,146	15%	N/A	N/A	\$134	\$271	\$163	\$61	N/A	\$80
ROUND (RND)													
VSXBAR	24	\$2,112	\$2,323	\$2,429	15%	N/A	\$112	\$134	\$271	\$163	\$61	\$338	\$80
VSXBAR	30	\$2,597	\$2,857	\$2,987	15%	N/A	\$112	\$134	\$271	\$163	\$61	\$338	\$80
VSXBAR	36	\$3,334	\$3,668	\$3,834	15%	N/A	\$112	\$134	\$271	\$163	\$61	\$338	\$80
VSXBAR	42	\$4,047	\$4,452	\$4,654	15%	N/A	\$112	\$134	\$271	\$163	\$61	\$338	\$80
VSXBAR	48	\$3,888	\$4,277	\$4,472	15%	N/A	\$112	\$134	\$271	\$163	\$61	\$338	\$80
VSXBAR	54	\$4,605	\$5,065	\$5,296	15%	N/A	N/A	\$134	\$271	\$163	\$61	N/A	\$80
VSXBAR	60	\$5,465	\$6,011	\$6,284	15%	N/A	N/A	\$134	\$271	\$163	\$61	N/A	\$80
VSXBAR	72 (2 piece)	\$8,180	\$8,998	\$9,407	15%	N/A	N/A	\$134	\$271	\$163	\$61	N/A	\$80
RECTANGLE (REC)													
VS1BAR	18x48	\$2,035	\$2,238	\$2,340	15%	\$389	N/A	\$134	\$339	\$163	\$61	N/A	\$133
VS1BAR	18x60	\$2,313	\$2,544	\$2,659	15%	\$389	N/A	\$134	\$339	\$163	\$61	N/A	\$133
VS1BAR	18x72	\$2,598	\$2,858	\$2,987	15%	\$389	N/A	\$134	\$339	\$163	\$61	N/A	\$133
VS1BAR	18x84	\$3,168	\$3,485	\$3,643	15%	\$389	N/A	\$134	\$339	\$163	\$61	N/A	\$133
VS1BAR	18x96	\$3,168	\$3,485	\$3,643	15%	\$389	N/A	\$134	\$339	\$163	\$61	N/A	\$133
VSXBAR20	24x30	\$2,134	\$2,347	\$2,454	15%	N/A	\$112	\$134	\$271	\$163	\$61	\$338	\$80
VSXBAR20	24x36	\$2,324	\$2,556	\$2,672	15%	N/A	\$112	\$134	\$271	\$163	\$61	\$338	\$80
VS1BAR	24x48	\$2,722	\$2,995	\$3,131	15%	\$389	N/A	\$134	\$339	\$163	\$61	N/A	\$133
VS1BAR	24x60	\$2,372	\$2,609	\$2,728	15%	\$389	N/A	\$134	\$339	\$163	\$61	N/A	\$133
VS1BAR	24x72	\$2,657	\$2,923	\$3,056	15%	\$389	N/A	\$134	\$339	\$163	\$61	N/A	\$133
VS1BAR	24x84	\$3,228	\$3,551	\$3,712	15%	\$389	N/A	\$134	\$339	\$163	\$61	N/A	\$133
VS1BAR	24x96	\$3,228	\$3,551	\$3,712	15%	\$389	N/A	\$134	\$339	\$163	\$61	N/A	\$133
VS1BAR	24x120 (1 piece)	\$4,342	\$4,776	\$4,993	15%	N/A	N/A	\$134	\$339	\$244	\$91	N/A	\$133
VS1BAR	24x144 (1 piece)	\$4,611	\$5,072	\$5,303	15%	N/A	N/A	\$134	\$339	\$244	\$91	N/A	\$133
VSXBAR26	30x42	\$3,155	\$3,471	\$3,629	15%	N/A	\$112	\$134	\$271	\$163	\$61	\$338	\$80
VSXBAR26	30x48	\$3,396	\$3,736	\$3,905	15%	N/A	\$112	\$134	\$271	\$163	\$61	N/A	\$80
VS1BAR	30x48	\$3,154	\$3,470	\$3,628	15%	\$389	N/A	\$134	\$339	\$163	\$61	N/A	\$133
VS1BAR	30x60	\$2,777	\$3,055	\$3,194	15%	\$389	N/A	\$134	\$339	\$163	\$61	N/A	\$133
VS1BAR	30x72	\$3,128	\$3,441	\$3,598	15%	\$389	N/A	\$134	\$339	\$163	\$61	N/A	\$133
VS1BAR	30x84	\$3,831	\$4,214	\$4,405	15%	\$389	N/A	\$134	\$339	\$163	\$61	N/A	\$133
VS1BAR	30x96	\$3,831	\$4,214	\$4,405	15%	\$389	N/A	\$134	\$339	\$163	\$61	N/A	\$133
VS1BAR	30x120 (1 piece)	\$3,868	\$4,254	\$4,448	15%	N/A	N/A	\$134	\$339	\$244	\$91	N/A	\$133
VS1BAR	30x144 (1 piece)	\$4,190	\$4,609	\$4,818	15%	N/A	N/A	\$134	\$339	\$244	\$91	N/A	\$133
VSXBAR26	36x42	\$3,539	\$3,893	\$4,069	15%	N/A	\$112	\$134	\$271	\$163	\$61	\$338	\$80
VSXBAR26	36x48	\$2,898	\$3,187	\$3,332	15%	N/A	\$112	\$134	\$271	\$163	\$61	N/A	\$80
VS1BAR	36x48	\$2,712	\$2,983	\$3,118	15%	\$389	N/A	\$134	\$339	\$163	\$61	N/A	\$133
VS1BAR	36x60	\$3,128	\$3,441	\$3,598	15%	\$389	N/A	\$134	\$339	\$163	\$61	N/A	\$133
VS1BAR	36x72	\$3,545	\$3,900	\$4,077	15%	\$389	N/A	\$134	\$339	\$163	\$61	N/A	\$133







VS BAR - VOYAGER TABLES - PREMIUM SOLID STEEL (VENEER)



	Edge Choices: Wood (Red Oak & Maple)			Wood Upgrade	OPTIONS								
	V-12	V-23 V-18 V-16	V-19 V-17 V-32	Upgrade: Walnut / Mahogany / Cherry	NESTING	FLIP TOP	POWDERCOAT UPGRADE	CHROME	DELUXE CASTERS (BLK)	EQUALIZER GLIDES	CENTER MOUNT ELEC. COLUMN	SPECIAL HEIGHT	
				ADD	ADD	ADD	ADD	ADD	ADD	ADD	ADD	ADD	
VS1BAR 36x84	\$4,386	\$4,825	\$5,044	15%	\$389	N/A	\$134	\$339	\$163	\$61	N/A	\$133	
VS1BAR 36x96	\$4,386	\$4,825	\$5,044	15%	\$389	N/A	\$134	\$339	\$163	\$61	N/A	\$133	
VS1BAR 36x120 (1 piece)	\$4,144	\$4,559	\$4,766	15%	N/A	N/A	\$134	\$339	\$244	\$91	N/A	\$133	
VS1BAR 36x144 (1 piece)	\$4,519	\$4,971	\$5,196	15%	N/A	N/A	\$134	\$339	\$244	\$91	N/A	\$133	
VS1BAR 42x48	\$4,041	\$4,445	\$4,647	15%	N/A	N/A	\$134	\$339	\$163	\$61	N/A	\$133	
VS1BAR 42x60	\$4,678	\$5,145	\$5,379	15%	N/A	N/A	\$134	\$339	\$163	\$61	N/A	\$133	
VS1BAR 42x72	\$3,790	\$4,169	\$4,359	15%	N/A	N/A	\$134	\$339	\$163	\$61	N/A	\$133	
VS1BAR 42x84	\$4,003	\$4,404	\$4,604	15%	N/A	N/A	\$134	\$339	\$163	\$61	N/A	\$133	
VS1BAR 42x96	\$4,217	\$4,638	\$4,849	15%	N/A	N/A	\$134	\$339	\$163	\$61	N/A	\$133	
VS1BAR 42x120 (1 piece)	\$4,643	\$5,108	\$5,340	15%	N/A	N/A	\$134	\$339	\$163	\$61	N/A	\$133	
VS1BAR 42x144 (1 piece)	\$5,070	\$5,577	\$5,831	15%	N/A	N/A	\$134	\$339	\$163	\$61	N/A	\$133	
VS2BAR 48x60	\$5,520	\$6,072	\$6,348	15%	N/A	N/A	\$134	\$542	\$163	\$61	N/A	\$228	
VS2BAR 48x72	\$6,242	\$6,866	\$7,178	15%	N/A	N/A	\$134	\$542	\$163	\$61	N/A	\$228	
VS2BAR 48x84	\$7,105	\$7,815	\$8,170	15%	N/A	N/A	\$134	\$542	\$163	\$61	N/A	\$228	
VS2BAR 48x96	\$7,105	\$7,815	\$8,170	15%	N/A	N/A	\$134	\$542	\$163	\$61	N/A	\$228	
VS2BAR 48x120 (1 piece)	\$7,405	\$8,146	\$8,516	15%	N/A	N/A	\$134	\$542	\$244	\$91	N/A	\$228	
VS2BAR 48x144 (1 piece)	\$8,597	\$9,457	\$9,887	15%	N/A	N/A	\$134	\$542	\$244	\$91	N/A	\$228	
VS2BAR 60x96	\$7,494	\$8,244	\$8,619	15%	N/A	N/A	\$134	\$542	\$163	\$61	N/A	\$228	
VS2BAR 60x120 (1 piece)	\$8,986	\$9,885	\$10,334	15%	N/A	N/A	\$134	\$542	\$244	\$91	N/A	\$228	
VS2BAR 60x144 (1 piece)	\$10,478	\$11,526	\$12,050	15%	N/A	N/A	\$134	\$542	\$244	\$91	N/A	\$228	
RACETRACK (RAC)													
VS1BAR 36x72	\$4,086	\$4,495	\$4,699	15%	\$389	N/A	\$134	\$339	\$163	\$61	N/A	\$133	
VS1BAR 36x84	\$4,920	\$5,412	\$5,658	15%	\$389	N/A	\$134	\$339	\$163	\$61	N/A	\$133	
VS1BAR 36x96	\$4,920	\$5,412	\$5,658	15%	\$389	N/A	\$134	\$339	\$163	\$61	N/A	\$133	
VS1BAR 36x120 (1 piece)	\$6,032	\$6,635	\$6,937	15%	N/A	N/A	\$134	\$339	\$244	\$91	N/A	\$133	
VS1BAR 36x144 (1 piece)	\$4,686	\$5,155	\$5,389	15%	N/A	N/A	\$134	\$339	\$244	\$91	N/A	\$133	
VS1BAR 42x96	\$4,384	\$4,823	\$5,042	15%	N/A	N/A	\$134	\$339	\$163	\$61	N/A	\$133	
VS1BAR 42x120 (1 piece)	\$4,811	\$5,292	\$5,533	15%	N/A	N/A	\$134	\$339	\$244	\$91	N/A	\$133	
VS1BAR 42x144 (1 piece)	\$5,238	\$5,761	\$6,023	15%	N/A	N/A	\$134	\$339	\$244	\$91	N/A	\$133	
VS2BAR 48x96	\$6,454	\$7,100	\$7,423	15%	N/A	N/A	\$134	\$542	\$163	\$61	N/A	\$228	
VS2BAR 48x120 (1 piece)	\$7,939	\$8,733	\$9,130	15%	N/A	N/A	\$134	\$542	\$244	\$91	N/A	\$228	
VS2BAR 48x144 (1 piece)	\$9,131	\$10,044	\$10,501	15%	N/A	N/A	\$134	\$542	\$244	\$91	N/A	\$228	
VS2BAR 60x96	\$8,028	\$8,831	\$9,233	15%	N/A	N/A	\$134	\$542	\$163	\$61	N/A	\$228	
VS2BAR 60x120 (1 piece)	\$9,520	\$10,472	\$10,948	15%	N/A	N/A	\$134	\$542	\$244	\$91	N/A	\$228	
VS2BAR 60x144 (1 piece)	\$11,012	\$12,113	\$12,664	15%	N/A	N/A	\$134	\$542	\$244	\$91	N/A	\$228	
BOAT (BOT)													
VS1BAR 36x48x96	\$5,485	\$6,033	\$6,308	15%	N/A	N/A	\$134	\$339	\$163	\$61	N/A	\$133	
VS1BAR 36x48x120 (1 piece)	\$6,845	\$7,530	\$7,872	15%	N/A	N/A	\$134	\$339	\$244	\$91	N/A	\$133	
VS1BAR 36x48x144 (1 piece)	\$5,567	\$6,124	\$6,402	15%	N/A	N/A	\$134	\$339	\$244	\$91	N/A	\$133	
VS2BAR 42x54x120 (1 piece)	\$6,089	\$6,697	\$7,002	15%	N/A	N/A	\$134	\$542	\$244	\$91	N/A	\$228	
VS2BAR 42x54x144 (1 piece)	\$6,620	\$7,282	\$7,613	15%	N/A	N/A	\$134	\$542	\$244	\$91	N/A	\$228	
VS2BAR 48x60x144 (1 piece)	\$10,208	\$11,228	\$11,739	15%	N/A	N/A	\$134	\$542	\$244	\$91	N/A	\$228	
OVAL (OVL)													
VS1BAR 36x60	\$3,223	\$3,545	\$3,706	15%	\$389	N/A	\$134	\$339	\$163	\$61	N/A	\$133	

VS BAR - VOYAGER TABLES - PREMIUM SOLID STEEL (VENEER)



		Edge Choices: Wood (Red Oak & Maple)			Wood Upgrade	OPTIONS							
		 V-12	 V-23	 V-19	Upgrade: Walnut / Mahogany / Cherry	NESTING	FLIP TOP	POWDERCOAT UPGRADE	CHROME	DELUXE CASTERS (BLK)	EQUALIZER GLIDES	CENTER MOUNT ELEC. COLUMN	SPECIAL HEIGHT
			 V-18	 V-17	ADD	ADD	ADD	ADD	ADD	ADD	ADD	ADD	ADD
			 V-16	 V-32									
VS1BAR	36x72	\$3,223	\$3,545	\$3,706	15%	\$389	N/A	\$134	\$339	\$163	\$61	N/A	\$133
VS1BAR	36x84	\$5,476	\$6,024	\$6,297	15%	\$389	N/A	\$134	\$339	\$163	\$61	N/A	\$133
VS1BAR	36x96	\$5,476	\$6,024	\$6,297	15%	\$389	N/A	\$134	\$339	\$163	\$61	N/A	\$133
VS1BAR	42x72	\$3,958	\$4,353	\$4,551	15%	N/A	N/A	\$134	\$339	\$163	\$61	N/A	\$133
VS1BAR	42x84	\$4,171	\$4,588	\$4,797	15%	N/A	N/A	\$134	\$339	\$163	\$61	N/A	\$133
VS1BAR	42x96	\$4,384	\$4,823	\$5,042	15%	N/A	N/A	\$134	\$339	\$163	\$61	N/A	\$133
VS2BAR	48x84	\$4,926	\$5,418	\$5,664	15%	N/A	N/A	\$134	\$542	\$163	\$61	N/A	\$228
VS2BAR	48x96	\$7,083	\$7,792	\$8,146	15%	N/A	N/A	\$134	\$542	\$163	\$61	N/A	\$228
VS2BAR	48x120 (1 piece)	\$8,853	\$9,738	\$10,181	15%	N/A	N/A	\$134	\$542	\$244	\$91	N/A	\$228
VS2BAR	48x144 (1 piece)	\$10,338	\$11,371	\$11,888	15%	N/A	N/A	\$134	\$542	\$244	\$91	N/A	\$228
VS2BAR	60x120 (1 piece)	\$10,800	\$11,880	\$12,420	15%	N/A	N/A	\$134	\$542	\$163	\$61	N/A	\$228
VS2BAR	60x144 (1 piece)	\$12,650	\$13,915	\$14,548	15%	N/A	N/A	\$134	\$542	\$244	\$91	N/A	\$228
TRAPEZOID (TRP)													
VS1BAR	24x24x48	\$2,695	\$2,964	\$3,099	15%	\$389	N/A	\$134	\$339	\$163	\$61	N/A	\$133
VS1BAR	24x36x60	\$3,121	\$3,433	\$3,589	15%	\$389	N/A	\$134	\$339	\$163	\$61	N/A	\$133
VS1BAR	30x30x60	\$3,087	\$3,396	\$3,550	15%	\$389	N/A	\$134	\$339	\$163	\$61	N/A	\$133
VS1BAR	30x42x72	\$3,592	\$3,951	\$4,131	15%	\$389	N/A	\$134	\$339	\$163	\$61	N/A	\$133
VS1BAR	36x36x72	\$3,563	\$3,920	\$4,098	15%	\$389	N/A	\$134	\$339	\$163	\$61	N/A	\$133
HALF ROUND (HRD)													
VS1BAR	24x48	\$2,585	\$2,843	\$2,973	15%	\$389	N/A	\$134	\$339	\$163	\$61	N/A	\$133
VS1BAR	30x60	\$2,971	\$3,268	\$3,416	15%	\$389	N/A	\$134	\$339	\$163	\$61	N/A	\$133
VS1BAR	36x72	\$3,440	\$3,785	\$3,957	15%	\$389	N/A	\$134	\$339	\$163	\$61	N/A	\$133
QTR ROUND (QRD)													
VS1BAR	24x24	\$2,341	\$2,575	\$2,692	15%	N/A	N/A	\$134	\$339	\$163	\$61	N/A	\$133
VS1BAR	30x30	\$2,601	\$2,861	\$2,991	15%	N/A	N/A	\$134	\$339	\$163	\$61	N/A	\$133
VS1BAR	36x36	\$2,918	\$3,210	\$3,356	15%	N/A	N/A	\$134	\$339	\$163	\$61	N/A	\$133
CRESCENT (CRT)													
VS1BAR	24x24x48	\$2,806	\$3,087	\$3,227	15%	\$389	N/A	\$134	\$339	\$163	\$61	N/A	\$133
VS1BAR	30x30x60	\$3,230	\$3,553	\$3,715	15%	\$389	N/A	\$134	\$339	\$163	\$61	N/A	\$133
VS1BAR	36x36x72	\$3,563	\$3,920	\$4,098	15%	\$389	N/A	\$134	\$339	\$163	\$61	N/A	\$133

VOLUMA



iQ and VOLUMA CONFERENCE TABLES

iQ Conference Tables are designed to complement the iQ Training Table line with a full series of conference tables utilizing the award winning leg design to enhance any space.

Table Pedestal Specifications

Finishes: Over 40+ powder coat finishes are offered to allow you to create the look you want in your space.

Glides and Casters: All tables are equipped with 2" diameter glides with brushed stainless steel cover over black plastic foot. The stem is M10 and 15mm long. The glide is suitable for carpet, as well as hard floors. Our high quality twin wheel locking casters are offered as an option.

Pedestal Specifications: The column is made of extruded aluminum in an oval shape that is 2" x 6 ¾" with an aluminum bottom plate and a Cast Aluminum Spider that is 5" x 9" that are attached with (2) 3/8" – 18 threaded steel rod and flange nuts at 35 ft/lbs torque. With 6 wood screws to attach the spider to the conference table top the base has a standard overall height of 27 ¾".

The Voluta series of conference tables provide tremendous options and designs for any conference room environment.

Base Specifications

Finishes: Available in any standard laminate or veneer.

Glides: Adjustable 1" diameter stainless steel, stem is ¼" – 20 x 1".

Specifications: Constructed using a combination of high grade particleboard and plywood, and can be covered with high pressure laminate or wood veneer which is book matched and finished without visible joinery. The bases may have 1 or 2 seams depending on the size of the base. In addition, there is a ¾" MDF mounting plate to attach the base to the conference table top with 6 wood screws per base. Options include a variety of grommet or access doors to allow ease of wiring for electrical and data.

Ballast: Pedastals are shipped without ballast. Customer is responsible for adding if necessary.

iQ and VOLUMA CONFERENCE TABLES



IQ CONFERENCE

	<u>Base Size</u>
IQC	2" x 6-3/4"
IQC-E1	2" x 6-3/4"
IQC-E2	2" x 6-3/4"

Top Capacity

Refer To Design Data Page
Refer To Design Data Page
Refer To Design Data Page

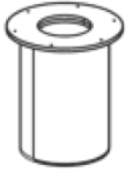

VOLUMA CYLINDER

	<u>Base Size</u>
CC18 (laminated)	18"
CC24 (laminated)	24"
CC30 (laminated)	30"
CC36 (laminated)	36"
CCV18 (veneer)	18"
CCV24 (veneer)	24"
CCV30 (veneer)	30"
CCV36 (veneer)	36"

Top Capacity

42" x 144"
48" x 144"
60" x 144"
72" Round Only

42" x 144"
48" x 144"
60" x 144"
72" Round Only

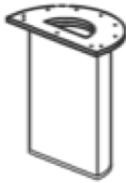

VOLUMA 1/2 CYLINDER

	<u>Base Size</u>
CH18 (laminated)	18"
CH24 (laminated)	24"
CH30 (laminated)	30"
CHV18 (veneer)	18"
CHV24 (veneer)	24"
CHV30 (veneer)	30"

Top Capacity

42" x 120"
48" x 120"
60" x 120"

42" x 120"
48" x 120"
60" x 120"



VOLUMA FLAT PANEL

	<u>Base Size</u>
CP18 (laminated)	18"
CP24 (laminated)	24"
CP36 (laminated)	36"

Top Capacity

42" x 96"
48" x 96"
60" x 96"

iQ and VOLUMA CONFERENCE TABLES



VOLUMA OVAL

CO20 (laminated)
CO26 (laminated)
CO36 (laminated)

Base Size

20"
26"
36"

Top Capacity

42" x 96"
48" x 96"
60" x 96"

COV20 (veneer)
COV26 (veneer)
COV36 (veneer)

20"
26"
36"

42" x 96"
48" x 96"
60" x 96"



VOLUMA BOAT

CB18 (laminated)
CB24 (laminated)
CB36 (laminated)

Base Size

18"
24"
36"

Top Capacity

42" x 96"
48" x 96"
60" x 96"

CBV18 (veneer)
CBV24 (veneer)
CBV36 (veneer)

18"
24"
36"

42" x 96"
48" x 96"
60" x 96"



VOLUMA ARCH

CA18 (laminated)
CA24 (laminated)
CA36 (laminated)

Base Size

18"
24"
36"

Top Capacity

42" x 96"
48" x 96"
60" x 96"

CAV18 (veneer)
CAV24 (veneer)
CAV36 (veneer)

18"
24"
36"

42" x 96"
48" x 96"
60" x 96"

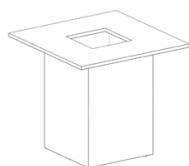

VOLUMA SQUARE

CSQ18 (laminated)
CSQ24 (laminated)
CSQ30 (laminated)
CSQ36 (laminated)

Base Size

18"
24"
30"
36"

Top Capacity

42" x 144"
48" x 144"
60" x 144"
72" Round Only

CSQV18 (veneer)
CSQV24 (veneer)
CSQV30 (veneer)
CAV36 (veneer)

18"
24"
30"
36"

42" x 144"
48" x 144"
60" x 144"
72" Round Only

VOLUMA CONFERENCE TABLES - (LAMINATE - PVC EDGE)

CYLINDER BASE - LAMINATE

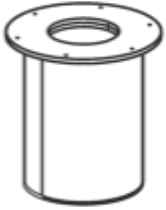

	# of Bases	Edge Choice: PVC & T-Mold				Laminate Upgrade		Light Weight	OPTIONS					SPECIAL HEIGHT
		T-15	L-21	P-14	PK-2	Laminate Upgrade I	Laminate Upgrade II	Light Weight (PVC only - 1" top)	Grommet - Top	Grommet - Bottom	Two Grommets	Accessory Door 10" x 10"	Accessory Door & Grommet Top	
		P-10 (self)	P-12	PK-4	L-15	L-23	ADD	ADD	ADD	Add Per Bas	Add Per Bas	Add Per Bas	Add Per Bas	
SQUARE (SQR)														
CC 42x42	1	\$1,702	\$1,787	\$1,872	\$128	\$340	\$298	\$121	\$121	\$242	\$716	\$811	\$474	
CC 48x48	1	\$1,904	\$2,000	\$2,095	\$143	\$381	\$333	\$121	\$121	\$242	\$716	\$811	\$474	
CC 54x54	1	\$2,032	\$2,134	\$2,236	\$152	\$406	N/A	\$121	\$121	\$242	\$716	\$811	\$474	
ROUND (RND)														
CC 48	1	\$1,833	\$1,924	\$2,016	\$137	\$367	\$321	\$121	\$121	\$242	\$716	\$811	\$474	
CC 54	1	\$2,045	\$2,147	\$2,250	\$153	\$409	\$358	\$121	\$121	\$242	\$716	\$811	\$474	
CC 60	1	\$2,183	\$2,292	\$2,401	\$164	\$437	\$382	\$121	\$121	\$242	\$716	\$811	\$474	
CC 72	1	\$2,950	\$3,097	\$3,245	\$221	\$590	\$516	\$121	\$121	\$242	\$716	\$811	\$474	
RECTANGLE (REC)														
CC 42x96	2	\$3,331	\$3,497	\$3,664	\$250	\$666	\$583	\$121	\$121	\$242	\$716	\$811	\$474	
CC 48x96	2	\$3,444	\$3,617	\$3,789	\$258	\$689	\$603	\$121	\$121	\$242	\$716	\$811	\$474	
CC 48x120 (1 piece)	2	\$3,687	\$3,871	\$4,056	\$277	\$737	\$645	\$121	\$121	\$242	\$716	\$811	\$474	
CC 48x144 (1 piece)	2	\$3,930	\$4,126	\$4,323	\$295	\$786	\$688	\$121	\$121	\$242	\$716	\$811	\$474	
CC 48x168 (2 pieces)	3	\$5,315	\$5,581	\$5,846	\$399	\$1,063	\$930	\$121	\$121	\$242	\$716	\$811	\$474	
CC 48x192 (2 pieces)	3	\$5,558	\$5,836	\$6,113	\$417	\$1,112	\$973	\$121	\$121	\$242	\$716	\$811	\$474	
CC 60x120 (1 piece)	2	\$4,143	\$4,350	\$4,558	\$311	\$829	\$725	\$121	\$121	\$242	\$716	\$811	\$474	
CC 60x144 (2 pieces)	2	\$4,439	\$4,661	\$4,883	\$333	\$888	\$777	\$121	\$121	\$242	\$716	\$811	\$474	
CC 60x168 (2 pieces)	3	\$5,965	\$6,263	\$6,562	\$447	\$1,193	\$1,044	\$121	\$121	\$242	\$716	\$811	\$474	
CC 60x192 (2 pieces)	3	\$6,261	\$6,574	\$6,887	\$470	\$1,252	\$1,096	\$121	\$121	\$242	\$716	\$811	\$474	
CC 60x240 (2 pieces)	4	\$8,083	\$8,487	\$8,891	\$606	\$1,617	\$1,414	\$121	\$121	\$242	\$716	\$811	\$474	
ARC RECTANGLE (ARCREC)														
CC 42x96	2	\$3,497	\$3,672	\$3,847	\$262	\$699	\$612	\$121	\$121	\$242	\$716	\$811	\$474	
CC 48x96	2	\$3,617	\$3,797	\$3,978	\$271	\$723	\$633	\$121	\$121	\$242	\$716	\$811	\$474	
CC 48x120 (1 piece)	2	\$3,871	\$4,065	\$4,259	\$290	\$774	\$677	\$121	\$121	\$242	\$716	\$811	\$474	
CC 48x144 (1 piece)	2	\$4,126	\$4,333	\$4,539	\$309	\$825	\$722	\$121	\$121	\$242	\$716	\$811	\$474	
CC 48x168 (2 pieces)	3	\$5,581	\$5,860	\$6,139	\$419	\$1,116	\$977	\$121	\$121	\$242	\$716	\$811	\$474	
CC 48x192 (2 pieces)	3	\$5,836	\$6,127	\$6,419	\$438	\$1,167	\$1,021	\$121	\$121	\$242	\$716	\$811	\$474	
CC 60x120 (1 piece)	2	\$4,350	\$4,568	\$4,785	\$326	\$870	\$761	\$121	\$121	\$242	\$716	\$811	\$474	
CC 60x144 (1 piece)	2	\$4,661	\$4,894	\$5,127	\$350	\$932	\$816	\$121	\$121	\$242	\$716	\$811	\$474	
CC 60x168 (2 pieces)	3	\$6,263	\$6,577	\$6,890	\$470	\$1,253	\$1,096	\$121	\$121	\$242	\$716	\$811	\$474	
CC 60x192 (2 pieces)	3	\$6,574	\$6,903	\$7,231	\$493	\$1,315	\$1,150	\$121	\$121	\$242	\$716	\$811	\$474	
CC 60x240 (2 pieces)	4	\$8,487	\$8,911	\$9,336	\$637	\$1,697	\$1,485	\$121	\$121	\$242	\$716	\$811	\$474	
RACETRACK (RAC)														

VOLUMA CONFERENCE TABLES - (LAMINATE - PVC EDGE)

CYLINDER BASE - LAMINATE

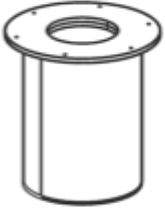

		Edge Choice: PVC & T-Mold				Laminate Upgrade		Light Weight	OPTIONS						
						Laminate Upgrade I	Laminate Upgrade II	Light Weight (PVC only - 1" top)	Grommet - Top	Grommet - Bottom	Two Grommets	Accessory Door 10"x10"	Accessory Door & Grommet Top	SPECIAL HEIGHT	
						ADD	ADD	ADD	Add Per Bas	Add Per Bas	Add Per Bas	Add Per Bas	Add Per Bas	ADD	
CC	42x84	2	\$3,307	\$3,473	\$3,638	\$248	\$661	\$579	\$121	\$121	\$242	\$716	\$811	\$474	
CC	42x96	2	\$3,416	\$3,586	\$3,757	\$256	\$683	\$598	\$121	\$121	\$242	\$716	\$811	\$474	
CC	48x96	2	\$3,529	\$3,706	\$3,882	\$265	\$706	\$618	\$121	\$121	\$242	\$716	\$811	\$474	
CC	48x120 (1 piece)	2	\$3,772	\$3,961	\$4,149	\$283	\$754	\$660	\$121	\$121	\$242	\$716	\$811	\$474	
CC	48x144 (1 piece)	2	\$4,015	\$4,215	\$4,416	\$301	\$803	\$703	\$121	\$121	\$242	\$716	\$811	\$474	
CC	60x144 (1 piece)	2	\$4,524	\$4,750	\$4,976	\$339	\$905	\$792	\$121	\$121	\$242	\$716	\$811	\$474	
CC	60x192 (2 pieces)	3	\$6,346	\$6,663	\$6,980	\$476	\$1,269	\$1,111	\$121	\$121	\$242	\$716	\$811	\$474	
CC	60x240 (2 pieces)	4	\$8,168	\$8,576	\$8,984	\$613	\$1,634	\$1,429	\$121	\$121	\$242	\$716	\$811	\$474	
BOAT (BOT)															
CC	42x54x120 (1 piece)	2	\$3,912	\$4,108	\$4,303	\$293	\$782	\$685	\$121	\$121	\$242	\$716	\$811	\$474	
CC	42x54x144 (1 piece)	2	\$4,181	\$4,390	\$4,600	\$314	\$836	\$732	\$121	\$121	\$242	\$716	\$811	\$474	
CC	48x60x192 (2 pieces)	3	\$6,346	\$6,663	\$6,980	\$476	\$1,269	\$1,111	\$121	\$121	\$242	\$716	\$811	\$474	
CC	48x60x240 (2 pieces)	3	\$6,937	\$7,284	\$7,631	\$520	\$1,387	\$1,214	\$121	\$121	\$242	\$716	\$811	\$474	
ARC BOAT (ARCBOT)															
CC	42x54x120 (1 piece)	2	\$4,108	\$4,313	\$4,519	\$308	\$822	\$719	\$121	\$121	\$242	\$716	\$811	\$474	
CC	42x54x144 (1 piece)	2	\$4,390	\$4,610	\$4,830	\$329	\$878	\$768	\$121	\$121	\$242	\$716	\$811	\$474	
CC	48x60x192 (2 pieces)	3	\$6,663	\$6,996	\$7,329	\$500	\$1,333	\$1,166	\$121	\$121	\$242	\$716	\$811	\$474	
CC	48x60x240 (2 pieces)	3	\$7,284	\$7,648	\$8,013	\$546	\$1,457	\$1,275	\$121	\$121	\$242	\$716	\$811	\$474	
OVAL (OVL)															
CC	42x96	2	\$3,416	\$3,586	\$3,757	\$256	\$683	\$598	\$121	\$121	\$242	\$716	\$811	\$474	
CC	48x96	2	\$3,529	\$3,706	\$3,882	\$265	\$706	\$618	\$121	\$121	\$242	\$716	\$811	\$474	
CC	48x120 (1 piece)	2	\$3,772	\$3,961	\$4,149	\$283	\$754	\$660	\$121	\$121	\$242	\$716	\$811	\$474	
CC	48x144 (1 piece)	2	\$4,015	\$4,215	\$4,416	\$301	\$803	\$703	\$121	\$121	\$242	\$716	\$811	\$474	
CC	60x120 (1 piece)	2	\$4,228	\$4,440	\$4,651	\$317	\$846	\$740	\$121	\$121	\$242	\$716	\$811	\$474	
CC	60x144 (1 piece)	2	\$4,524	\$4,750	\$4,976	\$339	\$905	\$792	\$121	\$121	\$242	\$716	\$811	\$474	

VOLUMA CONFERENCE TABLES - (LAMINATE - WOOD ED

CYLINDER BASE - LAMINATE

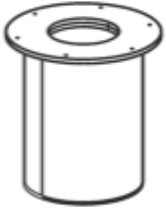

	# of Bases	Edge Choice: Wood (Red Oak & Maple)			Wood Upgrade	OPTIONS					SPECIAL HEIGHT
		W-12	W-23 W-18 W-16	W-19 W-17 W-32	Upgrade: Walnut / Mahogany / Cherry	Grommet - Top	Grommet - Bottom	Two Grommets	Accessory Door 10" x 10"	Accessory Door & Grommet Top	
					ADD	Add Per Bas	Add Per Bas	Add Per Bas	Add Per Bas	Add Per Bas	ADD
SQUARE (SQR)											
CC 42x42	1	\$3,191	\$3,829	\$4,254	15%	\$121	\$121	\$242	\$716	\$811	\$474
CC 48x48	1	\$3,571	\$4,285	\$4,761	15%	\$121	\$121	\$242	\$716	\$811	\$474
CC 54x54	1	\$3,811	\$4,573	\$5,081	15%	\$121	\$121	\$242	\$716	\$811	\$474
ROUND (RND)											
CC 48	1	\$3,436	\$4,123	\$4,581	15%	\$121	\$121	\$242	\$716	\$811	\$474
CC 54	1	\$3,835	\$4,602	\$5,113	15%	\$121	\$121	\$242	\$716	\$811	\$474
CC 60	1	\$4,093	\$4,912	\$5,458	15%	\$121	\$121	\$242	\$716	\$811	\$474
CC 72	1	\$5,531	\$6,637	\$7,375	15%	\$121	\$121	\$242	\$716	\$811	\$474
RECTANGLE (REC)											
CC 42x96	2	\$6,245	\$7,494	\$8,327	15%	\$121	\$121	\$242	\$716	\$811	\$474
CC 48x96	2	\$6,458	\$7,750	\$8,611	15%	\$121	\$121	\$242	\$716	\$811	\$474
CC 48x120 (1 piece)	2	\$6,913	\$8,296	\$9,218	15%	\$121	\$121	\$242	\$716	\$811	\$474
CC 48x144 (1 piece)	2	\$7,368	\$8,842	\$9,824	15%	\$121	\$121	\$242	\$716	\$811	\$474
CC 48x168 (2 pieces)	3	\$9,966	\$11,959	\$13,287	15%	\$121	\$121	\$242	\$716	\$811	\$474
CC 48x192 (2 pieces)	3	\$10,421	\$12,505	\$13,894	15%	\$121	\$121	\$242	\$716	\$811	\$474
CC 60x120 (1 piece)	2	\$7,769	\$9,322	\$10,358	15%	\$121	\$121	\$242	\$716	\$811	\$474
CC 60x144 (2 pieces)	2	\$8,323	\$9,988	\$11,098	15%	\$121	\$121	\$242	\$716	\$811	\$474
CC 60x168 (2 pieces)	3	\$11,185	\$13,422	\$14,913	15%	\$121	\$121	\$242	\$716	\$811	\$474
CC 60x192 (2 pieces)	3	\$11,739	\$14,087	\$15,652	15%	\$121	\$121	\$242	\$716	\$811	\$474
CC 60x240 (2 pieces)	4	\$15,155	\$18,186	\$20,207	15%	\$121	\$121	\$242	\$716	\$811	\$474
ARC RECTANGLE (ARC REC)											
CC 42x96	2	\$6,557	\$7,869	\$8,743	15%	\$121	\$121	\$242	\$716	\$811	\$474
CC 48x96	2	\$6,781	\$8,137	\$9,041	15%	\$121	\$121	\$242	\$716	\$811	\$474
CC 48x120 (1 piece)	2	\$7,259	\$8,711	\$9,678	15%	\$121	\$121	\$242	\$716	\$811	\$474
CC 48x144 (1 piece)	2	\$7,737	\$9,284	\$10,316	15%	\$121	\$121	\$242	\$716	\$811	\$474
CC 48x168 (2 pieces)	3	\$10,464	\$12,557	\$13,952	15%	\$121	\$121	\$242	\$716	\$811	\$474
CC 48x192 (2 pieces)	3	\$10,942	\$13,130	\$14,589	15%	\$121	\$121	\$242	\$716	\$811	\$474
CC 60x120 (1 piece)	2	\$8,157	\$9,788	\$10,876	15%	\$121	\$121	\$242	\$716	\$811	\$474
CC 60x144 (1 piece)	2	\$8,739	\$10,487	\$11,652	15%	\$121	\$121	\$242	\$716	\$811	\$474
CC 60x168 (2 pieces)	3	\$11,744	\$14,093	\$15,659	15%	\$121	\$121	\$242	\$716	\$811	\$474
CC 60x192 (2 pieces)	3	\$12,326	\$14,791	\$16,435	15%	\$121	\$121	\$242	\$716	\$811	\$474
CC 60x240 (2 pieces)	4	\$15,913	\$19,096	\$21,217	15%	\$121	\$121	\$242	\$716	\$811	\$474
RACETRACK (RAC)											

VOLUMA CONFERENCE TABLES - (LAMINATE - WOOD ED

CYLINDER BASE - LAMINATE

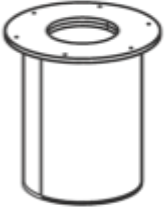

		Edge Choice: Wood (Red Oak & Maple)			Wood Upgrade	OPTIONS						
		W-12	W-23	W-19	Upgrade: Walnut / Mahogany / Cherry	Grommet - Top	Grommet - Bottom	Two Grommets	Accessory Door 10"x10"	Accessory Door & Grommet Top	SPECIAL HEIGHT	
			W-18	W-17		ADD	Add Per Bas	Add Per Bas	Add Per Bas	Add Per Bas	Add Per Bas	ADD
			W-16	W-32								
CC	42x84	2	\$6,201	\$7,442	\$8,269	15%	\$121	\$121	\$242	\$716	\$811	\$474
CC	42x96	2	\$6,404	\$7,685	\$8,539	15%	\$121	\$121	\$242	\$716	\$811	\$474
CC	48x96	2	\$6,617	\$7,941	\$8,823	15%	\$121	\$121	\$242	\$716	\$811	\$474
CC	48x120 (1 piece)	2	\$7,072	\$8,487	\$9,430	15%	\$121	\$121	\$242	\$716	\$811	\$474
CC	48x144 (1 piece)	2	\$7,528	\$9,033	\$10,037	15%	\$121	\$121	\$242	\$716	\$811	\$474
CC	60x144 (1 piece)	2	\$8,482	\$10,179	\$11,310	15%	\$121	\$121	\$242	\$716	\$811	\$474
CC	60x192 (2 pieces)	3	\$11,898	\$14,278	\$15,865	15%	\$121	\$121	\$242	\$716	\$811	\$474
CC	60x240 (2 pieces)	4	\$15,314	\$18,377	\$20,419	15%	\$121	\$121	\$242	\$716	\$811	\$474
BOAT (BOT)												
CC	42x54x120 (1 piece)	2	\$7,335	\$8,802	\$9,780	15%	\$121	\$121	\$242	\$716	\$811	\$474
CC	42x54x144 (1 piece)	2	\$7,840	\$9,408	\$10,454	15%	\$121	\$121	\$242	\$716	\$811	\$474
CC	48x60x192 (2 pieces)	3	\$11,898	\$14,278	\$15,865	15%	\$121	\$121	\$242	\$716	\$811	\$474
CC	48x60x240 (2 pieces)	3	\$13,007	\$15,609	\$17,343	15%	\$121	\$121	\$242	\$716	\$811	\$474
ARC BOAT (ARCBOT)												
CC	42x54x120 (1 piece)	2	\$7,702	\$9,243	\$10,270	15%	\$121	\$121	\$242	\$716	\$811	\$474
CC	42x54x144 (1 piece)	2	\$8,232	\$9,879	\$10,976	15%	\$121	\$121	\$242	\$716	\$811	\$474
CC	48x60x192 (2 pieces)	3	\$12,493	\$14,992	\$16,658	15%	\$121	\$121	\$242	\$716	\$811	\$474
CC	48x60x240 (2 pieces)	3	\$13,658	\$16,389	\$18,210	15%	\$121	\$121	\$242	\$716	\$811	\$474
OVAL (OVL)												
CC	42x96	2	\$6,404	\$7,685	\$8,539	15%	\$121	\$121	\$242	\$716	\$811	\$474
CC	48x96	2	\$6,617	\$7,941	\$8,823	15%	\$121	\$121	\$242	\$716	\$811	\$474
CC	48x120 (1 piece)	2	\$7,072	\$8,487	\$9,430	15%	\$121	\$121	\$242	\$716	\$811	\$474
CC	48x144 (1 piece)	2	\$7,528	\$9,033	\$10,037	15%	\$121	\$121	\$242	\$716	\$811	\$474
CC	60x120 (1 piece)	2	\$7,928	\$9,513	\$10,570	15%	\$121	\$121	\$242	\$716	\$811	\$474
CC	60x144 (1 piece)	2	\$8,482	\$10,179	\$11,310	15%	\$121	\$121	\$242	\$716	\$811	\$474

of Bases

VOLUMA CONFERENCE TABLES - (VENEER)

CYLINDER BASE - LAMINATE

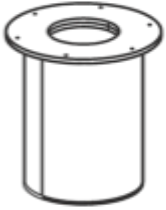



	# of Bases	Edge Choice: Wood (Red Oak & Maple)			Wood Upgrade	OPTIONS					SPECIAL HEIGHT
		V-12	V-23 V-18 V-16	V-19 V-17 V-32	Upgrade: Walnut / Mahogany / Cherry	Grommet - Top	Grommet - Bottom	Two Grommets	Accessory Door 10" x 10"	Accessory Door & Grommet Top	
					ADD	Add Per Bas	Add Per Bas	Add Per Bas	Add Per Bas	Add Per Bas	ADD
SQUARE (SQR)											
CC 42x42	1	\$3,788	\$4,167	\$4,356	15%	\$121	\$121	\$242	\$716	\$811	\$474
CC 48x48	1	\$4,593	\$5,052	\$5,282	15%	\$121	\$121	\$242	\$716	\$811	\$474
CC 54x54	1	\$4,573	\$5,030	\$5,259	15%	\$121	\$121	\$242	\$716	\$811	\$474
ROUND (RND)											
CC 48	1	\$3,886	\$4,275	\$4,469	15%	\$121	\$121	\$242	\$716	\$811	\$474
CC 54	1	\$4,696	\$4,930	\$5,400	15%	\$121	\$121	\$242	\$716	\$811	\$474
CC 60	1	\$5,485	\$6,034	\$6,308	15%	\$121	\$121	\$242	\$716	\$811	\$474
CC 72	1	\$7,657	\$8,423	\$8,806	15%	\$121	\$121	\$242	\$716	\$811	\$474
RECTANGLE (REC)											
CC 42x96	2	\$6,881	\$7,569	\$7,913	15%	\$121	\$121	\$242	\$716	\$811	\$474
CC 48x96	2	\$6,881	\$7,569	\$7,913	15%	\$121	\$121	\$242	\$716	\$811	\$474
CC 48x120 (1 piece)	2	\$8,365	\$9,202	\$9,620	15%	\$121	\$121	\$242	\$716	\$811	\$474
CC 48x144 (1 piece)	2	\$9,557	\$10,513	\$10,991	15%	\$121	\$121	\$242	\$716	\$811	\$474
CC 48x168 (2 pieces)	3	\$11,952	\$13,147	\$13,745	15%	\$121	\$121	\$242	\$716	\$811	\$474
CC 48x192 (2 pieces)	3	\$13,144	\$14,458	\$15,116	15%	\$121	\$121	\$242	\$716	\$811	\$474
CC 60x120 (1 piece)	2	\$10,042	\$11,046	\$11,549	15%	\$121	\$121	\$242	\$716	\$811	\$474
CC 60x144 (2 pieces)	2	\$11,534	\$12,687	\$13,264	15%	\$121	\$121	\$242	\$716	\$811	\$474
CC 60x168 (2 pieces)	3	\$14,314	\$15,745	\$16,461	15%	\$121	\$121	\$242	\$716	\$811	\$474
CC 60x192 (2 pieces)	3	\$15,806	\$17,386	\$18,176	15%	\$121	\$121	\$242	\$716	\$811	\$474
CC 60x240 (2 pieces)	4	\$20,084	\$22,093	\$23,097	15%	\$121	\$121	\$242	\$716	\$811	\$474
ARC RECTANGLE (ARC REC)											
CC 42x96	2	\$7,225	\$7,947	\$8,309	15%	\$121	\$121	\$242	\$716	\$811	\$474
CC 48x96	2	\$7,225	\$7,947	\$8,309	15%	\$121	\$121	\$242	\$716	\$811	\$474
CC 48x120 (1 piece)	2	\$8,784	\$9,662	\$10,101	15%	\$121	\$121	\$242	\$716	\$811	\$474
CC 48x144 (1 piece)	2	\$10,035	\$11,039	\$11,540	15%	\$121	\$121	\$242	\$716	\$811	\$474
CC 48x168 (2 pieces)	3	\$12,550	\$13,805	\$14,432	15%	\$121	\$121	\$242	\$716	\$811	\$474
CC 48x192 (2 pieces)	3	\$13,801	\$15,181	\$15,871	15%	\$121	\$121	\$242	\$716	\$811	\$474
CC 60x120 (1 piece)	2	\$10,544	\$11,599	\$12,126	15%	\$121	\$121	\$242	\$716	\$811	\$474
CC 60x144 (1 piece)	2	\$12,111	\$13,322	\$13,927	15%	\$121	\$121	\$242	\$716	\$811	\$474
CC 60x168 (2 pieces)	3	\$15,029	\$16,532	\$17,284	15%	\$121	\$121	\$242	\$716	\$811	\$474
CC 60x192 (2 pieces)	3	\$16,596	\$18,255	\$19,085	15%	\$121	\$121	\$242	\$716	\$811	\$474
CC 60x240 (2 pieces)	4	\$21,089	\$23,197	\$24,252	15%	\$121	\$121	\$242	\$716	\$811	\$474
RACETRACK (RAC)											

VOLUMA CONFERENCE TABLES - (VENEER)

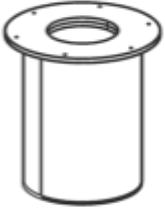
CYLINDER BASE - LAMINATE



		Edge Choice: Wood (Red Oak & Maple)			Wood Upgrade	OPTIONS						
		V-12	V-23	V-19	Upgrade: Walnut / Mahogany / Cherry	Grommet - Top	Grommet - Bottom	Two Grommets	Accessory Door 10"x10"	Accessory Door & Grommet Top	SPECIAL HEIGHT	
						ADD	Add Per Base	Add Per Base	Add Per Base	Add Per Base	Add Per Base	ADD
CC	42x84	2	\$7,442	\$8,186	\$8,558	15%	\$121	\$121	\$242	\$716	\$811	\$474
CC	42x96	2	\$7,685	\$8,453	\$8,838	15%	\$121	\$121	\$242	\$716	\$811	\$474
CC	48x96	2	\$7,415	\$8,156	\$8,527	15%	\$121	\$121	\$242	\$716	\$811	\$474
CC	48x120 (1 piece)	2	\$8,899	\$9,789	\$10,234	15%	\$121	\$121	\$242	\$716	\$811	\$474
CC	48x144 (1 piece)	2	\$10,091	\$11,100	\$11,605	15%	\$121	\$121	\$242	\$716	\$811	\$474
CC	60x144 (1 piece)	2	\$12,068	\$13,275	\$13,878	15%	\$121	\$121	\$242	\$716	\$811	\$474
CC	60x192 (2 pieces)	3	\$16,339	\$17,973	\$18,790	15%	\$121	\$121	\$242	\$716	\$811	\$474
CC	60x240 (2 pieces)	4	\$20,618	\$22,680	\$23,711	15%	\$121	\$121	\$242	\$716	\$811	\$474
BOAT (BOT)												
CC	42x54x120 (1 piece)	2	\$8,802	\$9,683	\$10,123	15%	\$121	\$121	\$242	\$716	\$811	\$474
CC	42x54x144 (1 piece)	2	\$9,408	\$10,349	\$10,819	15%	\$121	\$121	\$242	\$716	\$811	\$474
CC	48x60x192 (2 pieces)	3	\$15,455	\$17,000	\$17,773	15%	\$121	\$121	\$242	\$716	\$811	\$474
CC	48x60x240 (2 pieces)	3	\$18,343	\$20,177	\$21,095	15%	\$121	\$121	\$242	\$716	\$811	\$474
ARC BOAT (ARCBOT)												
CC	42x54x120 (1 piece)	2	\$9,243	\$10,167	\$10,629	15%	\$121	\$121	\$242	\$716	\$811	\$474
CC	42x54x144 (1 piece)	2	\$9,879	\$10,866	\$11,360	15%	\$121	\$121	\$242	\$716	\$811	\$474
CC	48x60x192 (2 pieces)	3	\$16,227	\$17,850	\$18,661	15%	\$121	\$121	\$242	\$716	\$811	\$474
CC	48x60x240 (2 pieces)	3	\$19,260	\$21,186	\$22,149	15%	\$121	\$121	\$242	\$716	\$811	\$474
OVAL (OVL)												
CC	42x96	2	\$8,044	\$8,848	\$9,250	15%	\$121	\$121	\$242	\$716	\$811	\$474
CC	48x96	2	\$8,044	\$8,848	\$9,250	15%	\$121	\$121	\$242	\$716	\$811	\$474
CC	48x120 (1 piece)	2	\$9,813	\$10,795	\$11,285	15%	\$121	\$121	\$242	\$716	\$811	\$474
CC	48x144 (1 piece)	2	\$11,298	\$12,428	\$12,993	15%	\$121	\$121	\$242	\$716	\$811	\$474
CC	60x120 (1 piece)	2	\$11,856	\$13,041	\$13,634	15%	\$121	\$121	\$242	\$716	\$811	\$474
CC	60x144 (1 piece)	2	\$13,706	\$15,077	\$15,762	15%	\$121	\$121	\$242	\$716	\$811	\$474

of Bases



VOLUMA CONFERENCE TABLES - (LAMINATE - PVC EDGE)

CYLINDER BASE - VENEER

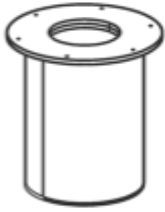

	# of Bases	Edge Choice: PVC & T-Mold				Laminate Upgrades		Light Weight	OPTIONS				
		T-15 P-10 (self) L-15	L-21 P-12	P-14	PK-2 PK-4 L-23	Laminate Upgrade I ADD	Laminate Upgrade II ADD	Light Weight (PVC only - 1" top) ADD	Grommet - Top Add Per Base	Grommet - Bottom Add Per Base	Two Grommets Add Per Base	Accessory Door 10" x 10" Add Per Base	Accessory Door & Grommet Top Add Per Base
SQUARE (SQR)													
CCV 42x42	1	\$1,987	\$2,087	\$2,186	\$149	\$397	\$348	\$121	\$121	\$242	\$716	\$811	\$474
CCV 48x48	1	\$2,256	\$2,369	\$2,481	\$169	\$451	\$395	\$121	\$121	\$242	\$716	\$811	\$474
CCV 54x54	1	\$2,384	\$2,503	\$2,622	\$179	\$477	N/A	\$121	\$121	\$242	\$716	\$811	\$474
ROUND (RND)													
CCV 48	1	\$2,118	\$2,224	\$2,330	\$159	\$424	\$371	\$121	\$121	\$242	\$716	\$811	\$474
CCV 54	1	\$2,397	\$2,517	\$2,636	\$180	\$479	\$419	\$121	\$121	\$242	\$716	\$811	\$474
CCV 60	1	\$2,535	\$2,661	\$2,788	\$190	\$507	\$444	\$121	\$121	\$242	\$716	\$811	\$474
CCV 72	1	\$3,301	\$3,466	\$3,632	\$248	\$660	\$578	\$121	\$121	\$242	\$716	\$811	\$474
RECTANGLE (REC)													
CCV 42x96	2	\$3,902	\$4,097	\$4,292	\$293	\$780	\$683	\$121	\$121	\$242	\$716	\$811	\$474
CCV 48x96	2	\$4,016	\$4,216	\$4,417	\$301	\$803	\$703	\$121	\$121	\$242	\$716	\$811	\$474
CCV 48x120 (1 piece)	2	\$4,258	\$4,471	\$4,684	\$319	\$852	\$745	\$121	\$121	\$242	\$716	\$811	\$474
CCV 48x144 (1 piece)	2	\$4,501	\$4,726	\$4,951	\$338	\$900	\$788	\$121	\$121	\$242	\$716	\$811	\$474
CCV 48x168 (2 pieces)	3	\$6,172	\$6,480	\$6,789	\$463	\$1,234	\$1,080	\$121	\$121	\$242	\$716	\$811	\$474
CCV 48x192 (2 pieces)	3	\$6,415	\$6,735	\$7,056	\$481	\$1,283	\$1,123	\$121	\$121	\$242	\$716	\$811	\$474
CCV 60x120 (1 piece)	2	\$4,846	\$5,089	\$5,331	\$363	\$969	\$848	\$121	\$121	\$242	\$716	\$811	\$474
CCV 60x144 (1 piece)	2	\$5,142	\$5,399	\$5,656	\$386	\$1,028	\$900	\$121	\$121	\$242	\$716	\$811	\$474
CCV 60x168 (2 pieces)	3	\$7,020	\$7,371	\$7,722	\$526	\$1,404	\$1,228	\$121	\$121	\$242	\$716	\$811	\$474
CCV 60x192 (2 pieces)	3	\$7,316	\$7,681	\$8,047	\$549	\$1,463	\$1,280	\$121	\$121	\$242	\$716	\$811	\$474
CCV 60x240 (2 pieces)	4	\$9,489	\$9,963	\$10,438	\$712	\$1,898	\$1,661	\$121	\$121	\$242	\$716	\$811	\$474
ARC RECTANGLE (ARC REC)													
CCV 42x96	2	\$4,097	\$4,302	\$4,507	\$307	\$819	\$717	\$121	\$121	\$242	\$716	\$811	\$474
CCV 48x96	2	\$4,216	\$4,427	\$4,638	\$316	\$843	\$738	\$121	\$121	\$242	\$716	\$811	\$474
CCV 48x120 (1 piece)	2	\$4,471	\$4,695	\$4,918	\$335	\$894	\$782	\$121	\$121	\$242	\$716	\$811	\$474
CCV 48x144 (1 piece)	2	\$4,726	\$4,962	\$5,199	\$354	\$945	\$827	\$121	\$121	\$242	\$716	\$811	\$474
CCV 48x168 (2 pieces)	3	\$6,480	\$6,804	\$7,128	\$486	\$1,296	\$1,134	\$121	\$121	\$242	\$716	\$811	\$474
CCV 48x192 (2 pieces)	3	\$6,735	\$7,072	\$7,409	\$505	\$1,347	\$1,179	\$121	\$121	\$242	\$716	\$811	\$474
CCV 60x120 (1 piece)	2	\$5,089	\$5,343	\$5,598	\$382	\$1,018	\$891	\$121	\$121	\$242	\$716	\$811	\$474
CCV 60x144 (1 piece)	2	\$5,399	\$5,669	\$5,939	\$405	\$1,080	\$945	\$121	\$121	\$242	\$716	\$811	\$474
CCV 60x168 (2 pieces)	3	\$7,371	\$7,739	\$8,108	\$553	\$1,474	\$1,290	\$121	\$121	\$242	\$716	\$811	\$474
CCV 60x192 (2 pieces)	3	\$7,681	\$8,065	\$8,449	\$576	\$1,536	\$1,344	\$121	\$121	\$242	\$716	\$811	\$474
CCV 60x240 (2 pieces)	4	\$9,963	\$10,462	\$10,960	\$747	\$1,993	\$1,744	\$121	\$121	\$242	\$716	\$811	\$474
RACETRACK (RAC)													

VOLUMA CONFERENCE TABLES - (LAMINATE - PVC EDGE)

CYLINDER BASE - VENEER

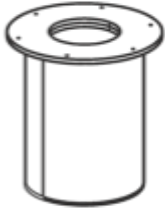

	# of Bases	Edge Choice: PVC & T-Mold				Laminate Upgrades		Light Weight	OPTIONS					
						Laminate Upgrade I	Laminate Upgrade II	Light Weight (PVC only - 1" top)	Grommet - Top	Grommet - Bottom	Two Grommets	Accessory Door 10"x10"	Accessory Door & Grommet Top	SPECIAL HEIGHT
						ADD	ADD	ADD	Add Per Base	Add Per Base	Add Per Base	Add Per Base	Add Per Base	ADD
CCV 42x84	2	\$3,879	\$4,073	\$4,267	\$291	\$776	\$679	\$121	\$121	\$242	\$716	\$811	\$474	
CCV 42x96	2	\$3,987	\$4,186	\$4,385	\$299	\$797	\$698	\$121	\$121	\$242	\$716	\$811	\$474	
CCV 48x96	2	\$4,100	\$4,306	\$4,511	\$308	\$820	\$718	\$121	\$121	\$242	\$716	\$811	\$474	
CCV 48x120 (1 piece)	2	\$4,343	\$4,560	\$4,778	\$326	\$869	\$760	\$121	\$121	\$242	\$716	\$811	\$474	
CCV 48x144 (1 piece)	2	\$4,586	\$4,815	\$5,045	\$344	\$917	\$803	\$121	\$121	\$242	\$716	\$811	\$474	
CCV 60x144 (1 piece)	2	\$5,227	\$5,488	\$5,750	\$392	\$1,045	\$915	\$121	\$121	\$242	\$716	\$811	\$474	
CCV 60x192 (2 pieces)	3	\$7,400	\$7,770	\$8,140	\$555	\$1,480	\$1,295	\$121	\$121	\$242	\$716	\$811	\$474	
CCV 60x240 (2 pieces)	4	\$9,574	\$10,053	\$10,531	\$718	\$1,915	\$1,675	\$121	\$121	\$242	\$716	\$811	\$474	
BOAT (BOT)														
CCV 42x54x120 (1 piece)	2	\$4,483	\$4,708	\$4,932	\$336	\$897	\$785	\$121	\$121	\$242	\$716	\$811	\$474	
CCV 42x54x144 (1 piece)	2	\$4,753	\$4,990	\$5,228	\$356	\$951	\$832	\$121	\$121	\$242	\$716	\$811	\$474	
CCV 48x60x192 (2 pieces)	3	\$7,400	\$7,770	\$8,140	\$555	\$1,480	\$1,295	\$121	\$121	\$242	\$716	\$811	\$474	
CCV 48x60x240 (2 pieces)	3	\$7,992	\$8,392	\$8,791	\$599	\$1,598	\$1,399	\$121	\$121	\$242	\$716	\$811	\$474	
ARC BOAT (ARCBOT)														
CCV 42x54x120 (1 piece)	2	\$4,708	\$4,943	\$5,178	\$353	\$942	\$824	\$121	\$121	\$242	\$716	\$811	\$474	
CCV 42x54x144 (1 piece)	2	\$4,990	\$5,240	\$5,489	\$374	\$998	\$873	\$121	\$121	\$242	\$716	\$811	\$474	
CCV 48x60x192 (2 pieces)	3	\$7,770	\$8,159	\$8,547	\$583	\$1,554	\$1,360	\$121	\$121	\$242	\$716	\$811	\$474	
CCV 48x60x240 (2 pieces)	3	\$8,392	\$8,811	\$9,231	\$629	\$1,678	\$1,469	\$121	\$121	\$242	\$716	\$811	\$474	
OVAL (OVL)														
CCV 42x96	2	\$3,987	\$4,186	\$4,385	\$299	\$797	\$698	\$121	\$121	\$242	\$716	\$811	\$474	
CCV 48x96	2	\$4,100	\$4,306	\$4,511	\$308	\$820	\$718	\$121	\$121	\$242	\$716	\$811	\$474	
CCV 48x120 (1 piece)	2	\$4,343	\$4,560	\$4,778	\$326	\$869	\$760	\$121	\$121	\$242	\$716	\$811	\$474	
CCV 48x144 (1 piece)	2	\$4,586	\$4,815	\$5,045	\$344	\$917	\$803	\$121	\$121	\$242	\$716	\$811	\$474	
CCV 60x120 (1 piece)	2	\$4,931	\$5,178	\$5,424	\$370	\$986	\$863	\$121	\$121	\$242	\$716	\$811	\$474	
CCV 60x144 (1 piece)	2	\$5,227	\$5,488	\$5,750	\$392	\$1,045	\$915	\$121	\$121	\$242	\$716	\$811	\$474	

VOLUMA CONFERENCE TABLES - (LAMINATE - WOOD EDGE

CYLINDER BASE - VENEER

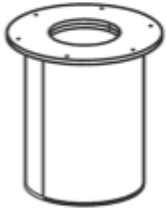







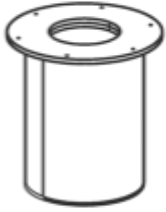





	# of Bases	Edge Choice: Wood (Red Oak & Maple)			Wood Upgrade	OPTIONS					
		W-12	W-23 W-18 W-16	W-19 W-17 W-32		Upgrade: Walnut / Mahogany / Cherry	Grommet - Top	Grommet - Bottom	Two Grommets	Accessory Door 10" x 10"	Accessory Door & Grommet Top
					ADD	Add Per Base	Add Per Base	Add Per Base	Add Per Base	Add Per Base	ADD
SQUARE (SQR)											
CCV 42x42	1	\$3,726	\$4,471	\$4,968	15%	\$121	\$121	\$242	\$716	\$811	\$474
CCV 48x48	1	\$4,230	\$5,076	\$5,640	15%	\$121	\$121	\$242	\$716	\$811	\$474
CCV 54x54	1	\$4,470	\$5,364	\$5,960	15%	\$121	\$121	\$242	\$716	\$811	\$474
ROUND (RND)											
CCV 48	1	\$3,972	\$4,766	\$5,296	15%	\$121	\$121	\$242	\$716	\$811	\$474
CCV 54	1	\$4,494	\$5,393	\$5,992	15%	\$121	\$121	\$242	\$716	\$811	\$474
CCV 60	1	\$4,752	\$5,703	\$6,337	15%	\$121	\$121	\$242	\$716	\$811	\$474
CCV 72	1	\$6,190	\$7,428	\$8,253	15%	\$121	\$121	\$242	\$716	\$811	\$474
RECTANGLE (REC)											
CCV 42x96	2	\$7,316	\$8,779	\$9,755	15%	\$121	\$121	\$242	\$716	\$811	\$474
CCV 48x96	2	\$7,529	\$9,035	\$10,039	15%	\$121	\$121	\$242	\$716	\$811	\$474
CCV 48x120 (1 piece)	2	\$7,984	\$9,581	\$10,646	15%	\$121	\$121	\$242	\$716	\$811	\$474
CCV 48x144 (1 piece)	2	\$8,439	\$10,127	\$11,253	15%	\$121	\$121	\$242	\$716	\$811	\$474
CCV 48x168 (2 pieces)	3	\$11,572	\$13,887	\$15,430	15%	\$121	\$121	\$242	\$716	\$811	\$474
CCV 48x192 (2 pieces)	3	\$12,027	\$14,433	\$16,036	15%	\$121	\$121	\$242	\$716	\$811	\$474
CCV 60x120 (1 piece)	2	\$9,087	\$10,904	\$12,116	15%	\$121	\$121	\$242	\$716	\$811	\$474
CCV 60x144 (1 piece)	2	\$9,641	\$11,570	\$12,855	15%	\$121	\$121	\$242	\$716	\$811	\$474
CCV 60x168 (2 pieces)	3	\$13,162	\$15,794	\$17,549	15%	\$121	\$121	\$242	\$716	\$811	\$474
CCV 60x192 (2 pieces)	3	\$13,717	\$16,460	\$18,289	15%	\$121	\$121	\$242	\$716	\$811	\$474
CCV 60x240 (2 pieces)	4	\$17,792	\$21,350	\$23,722	15%	\$121	\$121	\$242	\$716	\$811	\$474
ARC RECTANGLE (ARC REC)											
CCV 42x96	2	\$7,682	\$9,218	\$10,242	15%	\$121	\$121	\$242	\$716	\$811	\$474
CCV 48x96	2	\$7,906	\$9,487	\$10,541	15%	\$121	\$121	\$242	\$716	\$811	\$474
CCV 48x120 (1 piece)	2	\$8,384	\$10,060	\$11,178	15%	\$121	\$121	\$242	\$716	\$811	\$474
CCV 48x144 (1 piece)	2	\$8,861	\$10,634	\$11,815	15%	\$121	\$121	\$242	\$716	\$811	\$474
CCV 48x168 (2 pieces)	3	\$12,151	\$14,581	\$16,201	15%	\$121	\$121	\$242	\$716	\$811	\$474
CCV 48x192 (2 pieces)	3	\$12,629	\$15,154	\$16,838	15%	\$121	\$121	\$242	\$716	\$811	\$474
CCV 60x120 (1 piece)	2	\$9,541	\$11,450	\$12,722	15%	\$121	\$121	\$242	\$716	\$811	\$474
CCV 60x144 (1 piece)	2	\$10,124	\$12,148	\$13,498	15%	\$121	\$121	\$242	\$716	\$811	\$474
CCV 60x168 (2 pieces)	3	\$13,820	\$16,584	\$18,427	15%	\$121	\$121	\$242	\$716	\$811	\$474
CCV 60x192 (2 pieces)	3	\$14,402	\$17,283	\$19,203	15%	\$121	\$121	\$242	\$716	\$811	\$474
CCV 60x240 (2 pieces)	4	\$18,681	\$22,418	\$24,908	15%	\$121	\$121	\$242	\$716	\$811	\$474
RACETRACK (RAC)											

VOLUMA CONFERENCE TABLES - (LAMINATE - WOOD EDGE)

CYLINDER BASE - VENEER



	# of Bases	Edge Choice: Wood (Red Oak & Maple)			Wood Upgrade	OPTIONS					
					Upgrade: Walnut / Mahogany / Cherry	Grommet - Top	Grommet - Bottom	Two Grommets	Accessory Door 10"x10"	Accessory Door & Grommet Top	SPECIAL HEIGHT
				ADD		Add Per Base	Add Per Base	Add Per Base	Add Per Base	Add Per Base	ADD
											
CCV 42x84	2	\$7,273	\$8,727	\$9,697	15%	\$121	\$121	\$242	\$716	\$811	\$474
CCV 42x96	2	\$7,475	\$8,970	\$9,967	15%	\$121	\$121	\$242	\$716	\$811	\$474
CCV 48x96	2	\$7,688	\$9,226	\$10,251	15%	\$121	\$121	\$242	\$716	\$811	\$474
CCV 48x120 (1 piece)	2	\$8,144	\$9,772	\$10,858	15%	\$121	\$121	\$242	\$716	\$811	\$474
CCV 48x144 (1 piece)	2	\$8,599	\$10,318	\$11,465	15%	\$121	\$121	\$242	\$716	\$811	\$474
CCV 60x144 (1 piece)	2	\$9,801	\$11,761	\$13,068	15%	\$121	\$121	\$242	\$716	\$811	\$474
CCV 60x192 (2 pieces)	3	\$13,876	\$16,651	\$18,501	15%	\$121	\$121	\$242	\$716	\$811	\$474
CCV 60x240 (2 pieces)	4	\$17,951	\$21,541	\$23,935	15%	\$121	\$121	\$242	\$716	\$811	\$474
BOAT (BOT)											
CCV 42x54x120 (1 piece)	2	\$8,406	\$10,088	\$11,209	15%	\$121	\$121	\$242	\$716	\$811	\$474
CCV 42x54x144 (1 piece)	2	\$8,911	\$10,693	\$11,882	15%	\$121	\$121	\$242	\$716	\$811	\$474
CCV 48x60x192 (2 pieces)	3	\$13,876	\$16,651	\$18,501	15%	\$121	\$121	\$242	\$716	\$811	\$474
CCV 48x60x240 (2 pieces)	3	\$14,985	\$17,982	\$19,980	15%	\$121	\$121	\$242	\$716	\$811	\$474
ARC BOAT (ARCBOT)											
CCV 42x54x120 (1 piece)	2	\$8,827	\$10,592	\$11,769	15%	\$121	\$121	\$242	\$716	\$811	\$474
CCV 42x54x144 (1 piece)	2	\$9,357	\$11,228	\$12,476	15%	\$121	\$121	\$242	\$716	\$811	\$474
CCV 48x60x192 (2 pieces)	3	\$14,570	\$17,483	\$19,426	15%	\$121	\$121	\$242	\$716	\$811	\$474
CCV 48x60x240 (2 pieces)	3	\$15,734	\$18,881	\$20,979	15%	\$121	\$121	\$242	\$716	\$811	\$474
OVAL (OVL)											
CCV 42x96	2	\$7,475	\$8,970	\$9,967	15%	\$121	\$121	\$242	\$716	\$811	\$474
CCV 48x96	2	\$7,688	\$9,226	\$10,251	15%	\$121	\$121	\$242	\$716	\$811	\$474
CCV 48x120 (1 piece)	2	\$8,144	\$9,772	\$10,858	15%	\$121	\$121	\$242	\$716	\$811	\$474
CCV 48x144 (1 piece)	2	\$8,599	\$10,318	\$11,465	15%	\$121	\$121	\$242	\$716	\$811	\$474
CCV 60x120 (1 piece)	2	\$9,246	\$11,095	\$12,328	15%	\$121	\$121	\$242	\$716	\$811	\$474
CCV 60x144 (1 piece)	2	\$9,801	\$11,761	\$13,068	15%	\$121	\$121	\$242	\$716	\$811	\$474

VOLUMA CONFERENCE TABLES - (VENEER)

CYLINDER BASE - VENEER

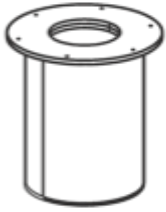



	# of Bases	Edge Choice: Wood (Red Oak & Maple)			Wood Upgrade	OPTIONS					
		V-12	V-23 V-18 V-16	V-19 V-17 V-32		Upgrade: Walnut / Mahogany / Cherry	Grommet - Top	Grommet - Bottom	Two Grommets	Accessory Door 10" x 10"	Accessory Door & Grommet Top
					ADD	Add Per Base	Add Per Base	Add Per Base	Add Per Base	Add Per Base	ADD
SQUARE (SQR)											
CCV 42x42	1	\$4,179	\$4,597	\$4,806	15%	\$121	\$121	\$242	\$716	\$811	\$474
CCV 48x48	1	\$5,074	\$5,581	\$5,835	15%	\$121	\$121	\$242	\$716	\$811	\$474
CCV 54x54	1	\$5,364	\$5,900	\$6,168	15%	\$121	\$121	\$242	\$716	\$811	\$474
ROUND (RND)											
CCV 48	1	\$4,187	\$4,606	\$4,815	15%	\$121	\$121	\$242	\$716	\$811	\$474
CCV 54	1	\$5,066	\$5,319	\$5,826	15%	\$121	\$121	\$242	\$716	\$811	\$474
CCV 60	1	\$5,856	\$6,441	\$6,734	15%	\$121	\$121	\$242	\$716	\$811	\$474
CCV 72	1	\$8,027	\$8,830	\$9,232	15%	\$121	\$121	\$242	\$716	\$811	\$474
RECTANGLE (REC)											
CCV 42x96	2	\$7,482	\$8,230	\$8,604	15%	\$121	\$121	\$242	\$716	\$811	\$474
CCV 48x96	2	\$7,482	\$8,230	\$8,604	15%	\$121	\$121	\$242	\$716	\$811	\$474
CCV 48x120 (1 piece)	2	\$8,967	\$9,863	\$10,312	15%	\$121	\$121	\$242	\$716	\$811	\$474
CCV 48x144 (1 piece)	2	\$10,159	\$11,175	\$11,682	15%	\$121	\$121	\$242	\$716	\$811	\$474
CCV 48x168 (2 pieces)	3	\$12,854	\$14,139	\$14,782	15%	\$121	\$121	\$242	\$716	\$811	\$474
CCV 48x192 (2 pieces)	3	\$14,046	\$15,451	\$16,153	15%	\$121	\$121	\$242	\$716	\$811	\$474
CCV 60x120 (1 piece)	2	\$10,782	\$11,861	\$12,400	15%	\$121	\$121	\$242	\$716	\$811	\$474
CCV 60x144 (1 piece)	2	\$12,274	\$13,502	\$14,115	15%	\$121	\$121	\$242	\$716	\$811	\$474
CCV 60x168 (2 pieces)	3	\$15,424	\$16,966	\$17,737	15%	\$121	\$121	\$242	\$716	\$811	\$474
CCV 60x192 (2 pieces)	3	\$16,916	\$18,607	\$19,453	15%	\$121	\$121	\$242	\$716	\$811	\$474
CCV 60x240 (2 pieces)	4	\$21,565	\$23,721	\$24,799	15%	\$121	\$121	\$242	\$716	\$811	\$474
ARC RECTANGLE (ARC REC)											
CCV 42x96	2	\$7,856	\$8,642	\$9,035	15%	\$121	\$121	\$242	\$716	\$811	\$474
CCV 48x96	2	\$7,856	\$8,642	\$9,035	15%	\$121	\$121	\$242	\$716	\$811	\$474
CCV 48x120 (1 piece)	2	\$9,415	\$10,356	\$10,827	15%	\$121	\$121	\$242	\$716	\$811	\$474
CCV 48x144 (1 piece)	2	\$10,667	\$11,733	\$12,267	15%	\$121	\$121	\$242	\$716	\$811	\$474
CCV 48x168 (2 pieces)	3	\$13,497	\$14,846	\$15,521	15%	\$121	\$121	\$242	\$716	\$811	\$474
CCV 48x192 (2 pieces)	3	\$14,748	\$16,223	\$16,961	15%	\$121	\$121	\$242	\$716	\$811	\$474
CCV 60x120 (1 piece)	2	\$11,321	\$12,454	\$13,020	15%	\$121	\$121	\$242	\$716	\$811	\$474
CCV 60x144 (1 piece)	2	\$12,888	\$14,177	\$14,821	15%	\$121	\$121	\$242	\$716	\$811	\$474
CCV 60x168 (2 pieces)	3	\$16,195	\$17,815	\$18,624	15%	\$121	\$121	\$242	\$716	\$811	\$474
CCV 60x192 (2 pieces)	3	\$17,761	\$19,538	\$20,426	15%	\$121	\$121	\$242	\$716	\$811	\$474
CCV 60x240 (2 pieces)	4	\$22,643	\$24,907	\$26,039	15%	\$121	\$121	\$242	\$716	\$811	\$474
RACETRACK (RAC)											

VOLUMA CONFERENCE TABLES - (VENEER)

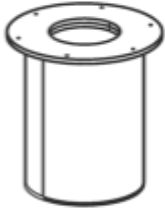
CYLINDER BASE - VENEER



	# of Bases	Edge Choice: Wood (Red Oak & Maple)			Wood Upgrade	OPTIONS					
		 V-12	 V-23	 V-19	Upgrade: Walnut / Mahogany / Cherry	Grommet - Top	Grommet - Bottom	Two Grommets	Accessory Door 10"x10"	Accessory Door & Grommet Top	SPECIAL HEIGHT
					ADD	Add Per Base	Add Per Base	Add Per Base	Add Per Base	Add Per Base	ADD
CCV 42x84	2	\$8,727	\$9,600	\$10,036	15%	\$121	\$121	\$242	\$716	\$811	\$474
CCV 42x96	2	\$8,970	\$9,867	\$10,316	15%	\$121	\$121	\$242	\$716	\$811	\$474
CCV 48x96	2	\$8,016	\$8,818	\$9,218	15%	\$121	\$121	\$242	\$716	\$811	\$474
CCV 48x120 (1 piece)	2	\$9,500	\$10,451	\$10,926	15%	\$121	\$121	\$242	\$716	\$811	\$474
CCV 48x144 (1 piece)	2	\$10,693	\$11,762	\$12,296	15%	\$121	\$121	\$242	\$716	\$811	\$474
CCV 60x144 (1 piece)	2	\$12,808	\$14,089	\$14,729	15%	\$121	\$121	\$242	\$716	\$811	\$474
CCV 60x192 (2 pieces)	3	\$17,450	\$19,194	\$20,067	15%	\$121	\$121	\$242	\$716	\$811	\$474
CCV 60x240 (2 pieces)	4	\$22,098	\$24,308	\$25,413	15%	\$121	\$121	\$242	\$716	\$811	\$474
BOAT (BOT)											
CCV 42x54x120 (1 piece)	2	\$10,088	\$11,097	\$11,601	15%	\$121	\$121	\$242	\$716	\$811	\$474
CCV 42x54x144 (1 piece)	2	\$10,693	\$11,763	\$12,298	15%	\$121	\$121	\$242	\$716	\$811	\$474
CCV 48x60x192 (2 pieces)	3	\$16,565	\$18,221	\$19,049	15%	\$121	\$121	\$242	\$716	\$811	\$474
CCV 48x60x240 (2 pieces)	3	\$19,453	\$21,399	\$22,371	15%	\$121	\$121	\$242	\$716	\$811	\$474
ARC BOAT (ARCBOT)											
CCV 42x54x120 (1 piece)	2	\$10,592	\$11,651	\$12,181	15%	\$121	\$121	\$242	\$716	\$811	\$474
CCV 42x54x144 (1 piece)	2	\$11,228	\$12,351	\$12,912	15%	\$121	\$121	\$242	\$716	\$811	\$474
CCV 48x60x192 (2 pieces)	3	\$17,393	\$19,132	\$20,002	15%	\$121	\$121	\$242	\$716	\$811	\$474
CCV 48x60x240 (2 pieces)	3	\$20,426	\$22,469	\$23,490	15%	\$121	\$121	\$242	\$716	\$811	\$474
OVAL (OVL)											
CCV 42x96	2	\$8,645	\$9,509	\$9,942	15%	\$121	\$121	\$242	\$716	\$811	\$474
CCV 48x96	2	\$8,645	\$9,509	\$9,942	15%	\$121	\$121	\$242	\$716	\$811	\$474
CCV 48x120 (1 piece)	2	\$10,415	\$11,456	\$11,977	15%	\$121	\$121	\$242	\$716	\$811	\$474
CCV 48x144 (1 piece)	2	\$11,899	\$13,089	\$13,684	15%	\$121	\$121	\$242	\$716	\$811	\$474
CCV 60x120 (1 piece)	2	\$12,596	\$13,855	\$14,485	15%	\$121	\$121	\$242	\$716	\$811	\$474
CCV 60x144 (1 piece)	2	\$14,446	\$15,891	\$16,613	15%	\$121	\$121	\$242	\$716	\$811	\$474

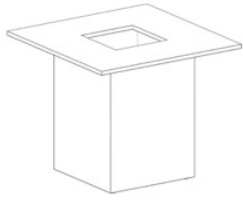

VOLUMA CONFERENCE TABLES - (LAMINATE - PVC EDGE)

SQUARE BASE - LAMINATE

	# of Bases	Edge Choice: PVC & T-Mold				Laminate Upgrade		Light Weight	OPTIONS					SPECIAL HEIGHT
		T-15	L-21	P-14	PK-2	Laminate Upgrade I	Laminate Upgrade II	Light Weight (PVC only - 1" top)	Grommet - Top	Grommet - Bottom	Two Grommets	Accessory Door 10" x 10"	Accessory Door & Grommet Top	
		P-10 (self)	P-12		PK-4	ADD	ADD	ADD	Add Per Bas	Add Per Bas	Add Per Bas	Add Per Bas	Add Per Bas	
SQUARE (SQR)														
CSQ 42x42	1	\$2,243	\$2,356	\$2,468	\$168	\$449	\$393	\$121	\$121	\$242	\$716	\$811	\$474	
CSQ 48x48	1	\$2,446	\$2,568	\$2,691	\$183	\$489	\$428	\$121	\$121	\$242	\$716	\$811	\$474	
CSQ 54x54	1	\$2,574	\$2,703	\$2,831	\$193	\$515	N/A	\$121	\$121	\$242	\$716	\$811	\$474	
ROUND (RND)														
CSQ 48	1	\$2,374	\$2,493	\$2,612	\$178	\$475	\$416	\$121	\$121	\$242	\$716	\$811	\$474	
CSQ 54	1	\$2,587	\$2,716	\$2,846	\$194	\$517	\$453	\$121	\$121	\$242	\$716	\$811	\$474	
CSQ 60	1	\$2,725	\$2,861	\$2,997	\$204	\$545	\$477	\$121	\$121	\$242	\$716	\$811	\$474	
CSQ 72	1	\$3,492	\$3,666	\$3,841	\$262	\$698	\$611	\$121	\$121	\$242	\$716	\$811	\$474	
RECTANGLE (REC)														
CSQ 42x96	2	\$4,414	\$4,635	\$4,855	\$331	\$883	\$772	\$121	\$121	\$242	\$716	\$811	\$474	
CSQ 48x96	2	\$4,528	\$4,754	\$4,981	\$340	\$906	\$792	\$121	\$121	\$242	\$716	\$811	\$474	
CSQ 48x120 (1 piece)	2	\$4,770	\$5,009	\$5,247	\$358	\$954	\$835	\$121	\$121	\$242	\$716	\$811	\$474	
CSQ 48x144 (1 piece)	2	\$5,013	\$5,264	\$5,514	\$376	\$1,003	\$877	\$121	\$121	\$242	\$716	\$811	\$474	
CSQ 48x168 (2 pieces)	3	\$6,940	\$7,287	\$7,634	\$521	\$1,388	\$1,215	\$121	\$121	\$242	\$716	\$811	\$474	
CSQ 48x192 (2 pieces)	3	\$7,183	\$7,542	\$7,901	\$539	\$1,437	\$1,257	\$121	\$121	\$242	\$716	\$811	\$474	
CSQ 60x120 (1 piece)	2	\$5,227	\$5,488	\$5,749	\$392	\$1,045	\$915	\$121	\$121	\$242	\$716	\$811	\$474	
CSQ 60x144 (2 pieces)	2	\$5,522	\$5,799	\$6,075	\$414	\$1,104	\$966	\$121	\$121	\$242	\$716	\$811	\$474	
CSQ 60x168 (2 pieces)	3	\$7,590	\$7,970	\$8,349	\$569	\$1,518	\$1,328	\$121	\$121	\$242	\$716	\$811	\$474	
CSQ 60x192 (2 pieces)	3	\$7,886	\$8,280	\$8,675	\$591	\$1,577	\$1,380	\$121	\$121	\$242	\$716	\$811	\$474	
CSQ 60x240 (2 pieces)	4	\$10,250	\$10,762	\$11,275	\$769	\$2,050	\$1,794	\$121	\$121	\$242	\$716	\$811	\$474	
ARC RECTANGLE (ARC REC)														
CSQ 42x96	2	\$4,581	\$4,810	\$5,039	\$344	\$916	\$802	\$121	\$121	\$242	\$716	\$811	\$474	
CSQ 48x96	2	\$4,700	\$4,935	\$5,170	\$352	\$940	\$822	\$121	\$121	\$242	\$716	\$811	\$474	
CSQ 48x120 (1 piece)	2	\$4,955	\$5,203	\$5,450	\$372	\$991	\$867	\$121	\$121	\$242	\$716	\$811	\$474	
CSQ 48x144 (1 piece)	2	\$5,210	\$5,470	\$5,731	\$391	\$1,042	\$912	\$121	\$121	\$242	\$716	\$811	\$474	
CSQ 48x168 (2 pieces)	3	\$7,206	\$7,566	\$7,926	\$540	\$1,441	\$1,261	\$121	\$121	\$242	\$716	\$811	\$474	
CSQ 48x192 (2 pieces)	3	\$7,461	\$7,834	\$8,207	\$560	\$1,492	\$1,306	\$121	\$121	\$242	\$716	\$811	\$474	
CSQ 60x120 (1 piece)	2	\$5,434	\$5,706	\$5,977	\$408	\$1,087	\$951	\$121	\$121	\$242	\$716	\$811	\$474	
CSQ 60x144 (1 piece)	2	\$5,744	\$6,032	\$6,319	\$431	\$1,149	\$1,005	\$121	\$121	\$242	\$716	\$811	\$474	
CSQ 60x168 (2 pieces)	3	\$7,889	\$8,283	\$8,677	\$592	\$1,578	\$1,380	\$121	\$121	\$242	\$716	\$811	\$474	
CSQ 60x192 (2 pieces)	3	\$8,199	\$8,609	\$9,019	\$615	\$1,640	\$1,435	\$121	\$121	\$242	\$716	\$811	\$474	
CSQ 60x240 (2 pieces)	4	\$10,654	\$11,186	\$11,719	\$799	\$2,131	\$1,864	\$121	\$121	\$242	\$716	\$811	\$474	
RACETRACK (RAC)														

VOLUMA CONFERENCE TABLES - (LAMINATE - PVC EDGE)

SQUARE BASE - LAMINATE

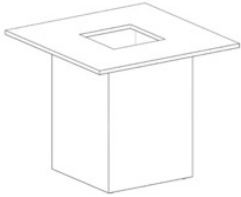

	# of Bases	Edge Choice: PVC & T-Mold				Laminate Upgrade		Light Weight	OPTIONS					
						Laminate Upgrade I	Laminate Upgrade II	Light Weight (PVC only - 1" top)	Grommet - Top	Grommet - Bottom	Two Grommets	Accessory Door 10"x10"	Accessory Door & Grommet Top	SPECIAL HEIGHT
						ADD	ADD	ADD	Add Per Bas	Add Per Bas	Add Per Bas	Add Per Bas	Add Per Bas	ADD
CSQ 42x84	2	\$4,391	\$4,610	\$4,830	\$329	\$878	\$768	\$121	\$121	\$242	\$716	\$811	\$474	
CSQ 42x96	2	\$4,499	\$4,724	\$4,949	\$337	\$900	\$787	\$121	\$121	\$242	\$716	\$811	\$474	
CSQ 48x96	2	\$4,613	\$4,843	\$5,074	\$346	\$923	\$807	\$121	\$121	\$242	\$716	\$811	\$474	
CSQ 48x120 (1 piece)	2	\$4,855	\$5,098	\$5,341	\$364	\$971	\$850	\$121	\$121	\$242	\$716	\$811	\$474	
CSQ 48x144 (1 piece)	2	\$5,098	\$5,353	\$5,608	\$382	\$1,020	\$892	\$121	\$121	\$242	\$716	\$811	\$474	
CSQ 60x144 (1 piece)	2	\$5,607	\$5,888	\$6,168	\$421	\$1,121	\$981	\$121	\$121	\$242	\$716	\$811	\$474	
CSQ 60x192 (2 pieces)	3	\$7,971	\$8,369	\$8,768	\$598	\$1,594	\$1,395	\$121	\$121	\$242	\$716	\$811	\$474	
CSQ 60x240 (2 pieces)	4	\$10,334	\$10,851	\$11,368	\$775	\$2,067	\$1,809	\$121	\$121	\$242	\$716	\$811	\$474	
BOAT (BOT)														
CSQ 42x54x120 (1 piece)	2	\$4,996	\$5,245	\$5,495	\$375	\$999	\$874	\$121	\$121	\$242	\$716	\$811	\$474	
CSQ 42x54x144 (1 piece)	2	\$5,265	\$5,528	\$5,791	\$395	\$1,053	\$921	\$121	\$121	\$242	\$716	\$811	\$474	
CSQ 48x60x192 (2 pieces)	3	\$7,971	\$8,369	\$8,768	\$598	\$1,594	\$1,395	\$121	\$121	\$242	\$716	\$811	\$474	
CSQ 48x60x240 (2 pieces)	3	\$8,562	\$8,991	\$9,419	\$642	\$1,712	\$1,498	\$121	\$121	\$242	\$716	\$811	\$474	
ARC BOAT (ARCBOT)														
CSQ 42x54x120 (1 piece)	2	\$5,191	\$5,451	\$5,710	\$389	\$1,038	\$908	\$121	\$121	\$242	\$716	\$811	\$474	
CSQ 42x54x144 (1 piece)	2	\$5,474	\$5,748	\$6,021	\$411	\$1,095	\$958	\$121	\$121	\$242	\$716	\$811	\$474	
CSQ 48x60x192 (2 pieces)	3	\$8,288	\$8,703	\$9,117	\$622	\$1,658	\$1,450	\$121	\$121	\$242	\$716	\$811	\$474	
CSQ 48x60x240 (2 pieces)	3	\$8,909	\$9,355	\$9,800	\$668	\$1,782	\$1,559	\$121	\$121	\$242	\$716	\$811	\$474	
OVAL (OVL)														
CSQ 42x96	2	\$4,499	\$4,724	\$4,949	\$337	\$900	\$787	\$121	\$121	\$242	\$716	\$811	\$474	
CSQ 48x96	2	\$4,613	\$4,843	\$5,074	\$346	\$923	\$807	\$121	\$121	\$242	\$716	\$811	\$474	
CSQ 48x120 (1 piece)	2	\$4,855	\$5,098	\$5,341	\$364	\$971	\$850	\$121	\$121	\$242	\$716	\$811	\$474	
CSQ 48x144 (1 piece)	2	\$5,098	\$5,353	\$5,608	\$382	\$1,020	\$892	\$121	\$121	\$242	\$716	\$811	\$474	
CSQ 60x120 (1 piece)	2	\$5,312	\$5,577	\$5,843	\$398	\$1,062	\$930	\$121	\$121	\$242	\$716	\$811	\$474	
CSQ 60x144 (1 piece)	2	\$5,607	\$5,888	\$6,168	\$421	\$1,121	\$981	\$121	\$121	\$242	\$716	\$811	\$474	

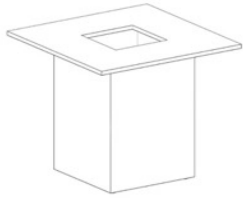

VOLUMA CONFERENCE TABLES - (LAMINATE - WOOD ED





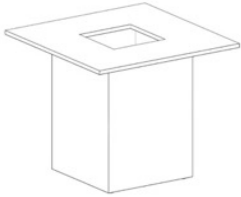





SQUARE BASE - LAMINATE

	# of Bases	Edge Choice: Wood (Red Oak & Maple)			Wood Upgrade	OPTIONS					
		W-12	W-23 W-18 W-16	W-19 W-17 W-32	Upgrade: Walnut / Mahogany / Cherry	Grommet - Top	Grommet - Bottom	Two Grommets	Accessory Door 10" x 10"	Accessory Door & Grommet Top	SPECIAL HEIGHT
					ADD	Add Per Bas	Add Per Bas	Add Per Bas	Add Per Bas	Add Per Bas	ADD
SQUARE (SQR)											
CSQ 42x42	1	\$4,206	\$5,048	\$5,608	15%	\$121	\$121	\$242	\$716	\$811	\$474
CSQ 48x48	1	\$4,586	\$5,504	\$6,115	15%	\$121	\$121	\$242	\$716	\$811	\$474
CSQ 54x54	1	\$4,826	\$5,791	\$6,435	15%	\$121	\$121	\$242	\$716	\$811	\$474
ROUND (RND)											
CSQ 48	1	\$4,452	\$5,342	\$5,936	15%	\$121	\$121	\$242	\$716	\$811	\$474
CSQ 54	1	\$4,850	\$5,820	\$6,467	15%	\$121	\$121	\$242	\$716	\$811	\$474
CSQ 60	1	\$5,109	\$6,131	\$6,812	15%	\$121	\$121	\$242	\$716	\$811	\$474
CSQ 72	1	\$6,547	\$7,856	\$8,729	15%	\$121	\$121	\$242	\$716	\$811	\$474
RECTANGLE (REC)											
CSQ 42x96	2	\$8,276	\$9,932	\$11,035	15%	\$121	\$121	\$242	\$716	\$811	\$474
CSQ 48x96	2	\$8,490	\$10,187	\$11,319	15%	\$121	\$121	\$242	\$716	\$811	\$474
CSQ 48x120 (1 piece)	2	\$8,945	\$10,734	\$11,926	15%	\$121	\$121	\$242	\$716	\$811	\$474
CSQ 48x144 (1 piece)	2	\$9,400	\$11,280	\$12,533	15%	\$121	\$121	\$242	\$716	\$811	\$474
CSQ 48x168 (2 pieces)	3	\$13,013	\$15,615	\$17,350	15%	\$121	\$121	\$242	\$716	\$811	\$474
CSQ 48x192 (2 pieces)	3	\$13,468	\$16,161	\$17,957	15%	\$121	\$121	\$242	\$716	\$811	\$474
CSQ 60x120 (1 piece)	2	\$9,800	\$11,760	\$13,067	15%	\$121	\$121	\$242	\$716	\$811	\$474
CSQ 60x144 (2 pieces)	2	\$10,355	\$12,425	\$13,806	15%	\$121	\$121	\$242	\$716	\$811	\$474
CSQ 60x168 (2 pieces)	3	\$14,232	\$17,078	\$18,976	15%	\$121	\$121	\$242	\$716	\$811	\$474
CSQ 60x192 (2 pieces)	3	\$14,786	\$17,744	\$19,715	15%	\$121	\$121	\$242	\$716	\$811	\$474
CSQ 60x240 (2 pieces)	4	\$19,218	\$23,062	\$25,624	15%	\$121	\$121	\$242	\$716	\$811	\$474
ARC RECTANGLE (ARC REC)											
CSQ 42x96	2	\$8,589	\$10,306	\$11,451	15%	\$121	\$121	\$242	\$716	\$811	\$474
CSQ 48x96	2	\$8,812	\$10,575	\$11,750	15%	\$121	\$121	\$242	\$716	\$811	\$474
CSQ 48x120 (1 piece)	2	\$9,290	\$11,148	\$12,387	15%	\$121	\$121	\$242	\$716	\$811	\$474
CSQ 48x144 (1 piece)	2	\$9,768	\$11,722	\$13,024	15%	\$121	\$121	\$242	\$716	\$811	\$474
CSQ 48x168 (2 pieces)	3	\$13,511	\$16,213	\$18,015	15%	\$121	\$121	\$242	\$716	\$811	\$474
CSQ 48x192 (2 pieces)	3	\$13,989	\$16,786	\$18,652	15%	\$121	\$121	\$242	\$716	\$811	\$474
CSQ 60x120 (1 piece)	2	\$10,188	\$12,226	\$13,585	15%	\$121	\$121	\$242	\$716	\$811	\$474
CSQ 60x144 (1 piece)	2	\$10,771	\$12,925	\$14,361	15%	\$121	\$121	\$242	\$716	\$811	\$474
CSQ 60x168 (2 pieces)	3	\$14,791	\$17,749	\$19,721	15%	\$121	\$121	\$242	\$716	\$811	\$474
CSQ 60x192 (2 pieces)	3	\$15,373	\$18,448	\$20,498	15%	\$121	\$121	\$242	\$716	\$811	\$474
CSQ 60x240 (2 pieces)	4	\$19,976	\$23,971	\$26,634	15%	\$121	\$121	\$242	\$716	\$811	\$474
RACETRACK (RAC)											



VOLUMA CONFERENCE TABLES - (LAMINATE - WOOD ED





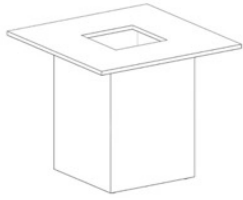

SQUARE BASE - LAMINATE

	# of Bases	Edge Choice: Wood (Red Oak & Maple)			Wood Upgrade	OPTIONS					
		 W-12	 W-23	 W-19	Upgrade: Walnut / Mahogany / Cherry	 Grommet - Top	 Grommet - Bottom	 Two Grommets	 Accessory Door 10"x10"	 Accessory Door & Grommet Top	SPECIAL HEIGHT
		 W-18	 W-17	ADD		Add Per Bas	Add Per Bas	Add Per Bas	Add Per Bas	Add Per Bas	ADD
CSQ 42x84	2	\$8,233	\$9,879	\$10,977	15%	\$121	\$121	\$242	\$716	\$811	\$474
CSQ 42x96	2	\$8,436	\$10,123	\$11,247	15%	\$121	\$121	\$242	\$716	\$811	\$474
CSQ 48x96	2	\$8,649	\$10,378	\$11,532	15%	\$121	\$121	\$242	\$716	\$811	\$474
CSQ 48x120 (1 piece)	2	\$9,104	\$10,925	\$12,138	15%	\$121	\$121	\$242	\$716	\$811	\$474
CSQ 48x144 (1 piece)	2	\$9,559	\$11,471	\$12,745	15%	\$121	\$121	\$242	\$716	\$811	\$474
CSQ 60x144 (1 piece)	2	\$10,514	\$12,617	\$14,018	15%	\$121	\$121	\$242	\$716	\$811	\$474
CSQ 60x192 (2 pieces)	3	\$14,945	\$17,935	\$19,927	15%	\$121	\$121	\$242	\$716	\$811	\$474
CSQ 60x240 (2 pieces)	4	\$19,377	\$23,253	\$25,836	15%	\$121	\$121	\$242	\$716	\$811	\$474
BOAT (BOT)											
CSQ 42x54x120 (1 piece)	2	\$9,367	\$11,240	\$12,489	15%	\$121	\$121	\$242	\$716	\$811	\$474
CSQ 42x54x144 (1 piece)	2	\$9,872	\$11,846	\$13,162	15%	\$121	\$121	\$242	\$716	\$811	\$474
CSQ 48x60x192 (2 pieces)	3	\$14,945	\$17,935	\$19,927	15%	\$121	\$121	\$242	\$716	\$811	\$474
CSQ 48x60x240 (2 pieces)	3	\$16,055	\$19,265	\$21,406	15%	\$121	\$121	\$242	\$716	\$811	\$474
ARC BOAT (ARCBOT)											
CSQ 42x54x120 (1 piece)	2	\$9,734	\$11,680	\$12,978	15%	\$121	\$121	\$242	\$716	\$811	\$474
CSQ 42x54x144 (1 piece)	2	\$10,264	\$12,316	\$13,685	15%	\$121	\$121	\$242	\$716	\$811	\$474
CSQ 48x60x192 (2 pieces)	3	\$15,540	\$18,648	\$20,721	15%	\$121	\$121	\$242	\$716	\$811	\$474
CSQ 48x60x240 (2 pieces)	3	\$16,705	\$20,046	\$22,273	15%	\$121	\$121	\$242	\$716	\$811	\$474
OVAL (OVL)											
CSQ 42x96	2	\$8,436	\$10,123	\$11,247	15%	\$121	\$121	\$242	\$716	\$811	\$474
CSQ 48x96	2	\$8,649	\$10,378	\$11,532	15%	\$121	\$121	\$242	\$716	\$811	\$474
CSQ 48x120 (1 piece)	2	\$9,104	\$10,925	\$12,138	15%	\$121	\$121	\$242	\$716	\$811	\$474
CSQ 48x144 (1 piece)	2	\$9,559	\$11,471	\$12,745	15%	\$121	\$121	\$242	\$716	\$811	\$474
CSQ 60x120 (1 piece)	2	\$9,959	\$11,951	\$13,279	15%	\$121	\$121	\$242	\$716	\$811	\$474
CSQ 60x144 (1 piece)	2	\$10,514	\$12,617	\$14,018	15%	\$121	\$121	\$242	\$716	\$811	\$474



VOLUMA CONFERENCE TABLES - (VENEER)









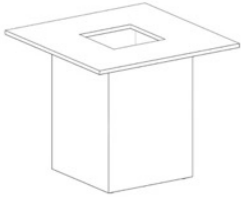



SQUARE BASE - LAMINATE

		Edge Choice: Wood (Red Oak & Maple)			Wood Upgrade	OPTIONS						
# of Bases		 V-12	 V-23	 V-19	Upgrade: Walnut / Mahogany / Cherry	Grommet - Top	Grommet - Bottom	Two Grommets	Accessory Door 10" x 10"	Accessory Door & Grommet Top	SPECIAL HEIGHT	
		 V-18	 V-17	 V-16		 V-32	ADD	Add Per Bas	Add Per Bas	Add Per Bas	Add Per Bas	Add Per Bas
SQUARE (SQR)												
CSQ	42x42	1	\$4,188	\$4,607	\$4,816	15%	\$121	\$121	\$242	\$716	\$811	\$474
CSQ	48x48	1	\$4,993	\$5,492	\$5,742	15%	\$121	\$121	\$242	\$716	\$811	\$474
CSQ	54x54	1	\$5,791	\$6,371	\$6,660	15%	\$121	\$121	\$242	\$716	\$811	\$474
ROUND (RND)												
CSQ	48	1	\$4,286	\$4,715	\$4,929	15%	\$121	\$121	\$242	\$716	\$811	\$474
CSQ	54	1	\$5,096	\$5,350	\$5,860	15%	\$121	\$121	\$242	\$716	\$811	\$474
CSQ	60	1	\$5,885	\$6,474	\$6,768	15%	\$121	\$121	\$242	\$716	\$811	\$474
CSQ	72	1	\$8,057	\$8,863	\$9,266	15%	\$121	\$121	\$242	\$716	\$811	\$474
RECTANGLE (REC)												
CSQ	42x96	2	\$7,681	\$8,449	\$8,833	15%	\$121	\$121	\$242	\$716	\$811	\$474
CSQ	48x96	2	\$7,681	\$8,449	\$8,833	15%	\$121	\$121	\$242	\$716	\$811	\$474
CSQ	48x120 (1 piece)	2	\$9,165	\$10,082	\$10,540	15%	\$121	\$121	\$242	\$716	\$811	\$474
CSQ	48x144 (1 piece)	2	\$10,357	\$11,393	\$11,911	15%	\$121	\$121	\$242	\$716	\$811	\$474
CSQ	48x168 (2 pieces)	3	\$13,152	\$14,467	\$15,125	15%	\$121	\$121	\$242	\$716	\$811	\$474
CSQ	48x192 (2 pieces)	3	\$14,344	\$15,778	\$16,496	15%	\$121	\$121	\$242	\$716	\$811	\$474
CSQ	60x120 (1 piece)	2	\$10,842	\$11,926	\$12,469	15%	\$121	\$121	\$242	\$716	\$811	\$474
CSQ	60x144 (2 pieces)	2	\$12,334	\$13,567	\$14,184	15%	\$121	\$121	\$242	\$716	\$811	\$474
CSQ	60x168 (2 pieces)	3	\$15,514	\$17,065	\$17,841	15%	\$121	\$121	\$242	\$716	\$811	\$474
CSQ	60x192 (2 pieces)	3	\$17,006	\$18,706	\$19,556	15%	\$121	\$121	\$242	\$716	\$811	\$474
CSQ	60x240 (2 pieces)	4	\$21,684	\$23,853	\$24,937	15%	\$121	\$121	\$242	\$716	\$811	\$474
ARC RECTANGLE (ARC REC)												
CSQ	42x96	2	\$8,025	\$8,827	\$9,229	15%	\$121	\$121	\$242	\$716	\$811	\$474
CSQ	48x96	2	\$8,025	\$8,827	\$9,229	15%	\$121	\$121	\$242	\$716	\$811	\$474
CSQ	48x120 (1 piece)	2	\$9,584	\$10,542	\$11,021	15%	\$121	\$121	\$242	\$716	\$811	\$474
CSQ	48x144 (1 piece)	2	\$10,835	\$11,919	\$12,460	15%	\$121	\$121	\$242	\$716	\$811	\$474
CSQ	48x168 (2 pieces)	3	\$13,750	\$15,125	\$15,812	15%	\$121	\$121	\$242	\$716	\$811	\$474
CSQ	48x192 (2 pieces)	3	\$15,001	\$16,501	\$17,251	15%	\$121	\$121	\$242	\$716	\$811	\$474
CSQ	60x120 (1 piece)	2	\$11,344	\$12,479	\$13,046	15%	\$121	\$121	\$242	\$716	\$811	\$474
CSQ	60x144 (1 piece)	2	\$12,911	\$14,202	\$14,847	15%	\$121	\$121	\$242	\$716	\$811	\$474
CSQ	60x168 (2 pieces)	3	\$16,229	\$17,852	\$18,664	15%	\$121	\$121	\$242	\$716	\$811	\$474
CSQ	60x192 (2 pieces)	3	\$17,796	\$19,575	\$20,465	15%	\$121	\$121	\$242	\$716	\$811	\$474
CSQ	60x240 (2 pieces)	4	\$22,689	\$24,957	\$26,092	15%	\$121	\$121	\$242	\$716	\$811	\$474
RACETRACK (RAC)												

VOLUMA CONFERENCE TABLES - (VENEER)

SQUARE BASE - LAMINATE



	# of Bases	Edge Choice: Wood (Red Oak & Maple)			Wood Upgrade	OPTIONS					
					Upgrade: Walnut / Mahogany / Cherry	Grommet - Top	Grommet - Bottom	Two Grommets	Accessory Door 10"x10"	Accessory Door & Grommet Top	SPECIAL HEIGHT
				ADD							
											
CSQ 42x84	2	\$9,879	\$10,867	\$11,361	15%	\$121	\$121	\$242	\$716	\$811	\$474
CSQ 42x96	2	\$10,123	\$11,135	\$11,641	15%	\$121	\$121	\$242	\$716	\$811	\$474
CSQ 48x96	2	\$8,215	\$9,036	\$9,447	15%	\$121	\$121	\$242	\$716	\$811	\$474
CSQ 48x120 (1 piece)	2	\$9,699	\$10,669	\$11,154	15%	\$121	\$121	\$242	\$716	\$811	\$474
CSQ 48x144 (1 piece)	2	\$10,891	\$11,980	\$12,525	15%	\$121	\$121	\$242	\$716	\$811	\$474
CSQ 60x144 (1 piece)	2	\$12,868	\$14,155	\$14,798	15%	\$121	\$121	\$242	\$716	\$811	\$474
CSQ 60x192 (2 pieces)	3	\$17,539	\$19,293	\$20,170	15%	\$121	\$121	\$242	\$716	\$811	\$474
CSQ 60x240 (2 pieces)	4	\$22,218	\$24,440	\$25,551	15%	\$121	\$121	\$242	\$716	\$811	\$474
BOAT (BOT)											
CSQ 42x54x120 (1 piece)	2	\$11,240	\$12,364	\$12,926	15%	\$121	\$121	\$242	\$716	\$811	\$474
CSQ 42x54x144 (1 piece)	2	\$11,846	\$13,030	\$13,623	15%	\$121	\$121	\$242	\$716	\$811	\$474
CSQ 48x60x192 (2 pieces)	3	\$16,655	\$18,320	\$19,153	15%	\$121	\$121	\$242	\$716	\$811	\$474
CSQ 48x60x240 (2 pieces)	3	\$19,543	\$21,497	\$22,475	15%	\$121	\$121	\$242	\$716	\$811	\$474
ARC BOAT (ARCBOT)											
CSQ 42x54x120 (1 piece)	2	\$11,680	\$12,848	\$13,432	15%	\$121	\$121	\$242	\$716	\$811	\$474
CSQ 42x54x144 (1 piece)	2	\$12,316	\$13,548	\$14,164	15%	\$121	\$121	\$242	\$716	\$811	\$474
CSQ 48x60x192 (2 pieces)	3	\$17,427	\$19,170	\$20,041	15%	\$121	\$121	\$242	\$716	\$811	\$474
CSQ 48x60x240 (2 pieces)	3	\$20,460	\$22,506	\$23,529	15%	\$121	\$121	\$242	\$716	\$811	\$474
OVAL (OVL)											
CSQ 42x96	2	\$8,844	\$9,728	\$10,170	15%	\$121	\$121	\$242	\$716	\$811	\$474
CSQ 48x96	2	\$8,844	\$9,728	\$10,170	15%	\$121	\$121	\$242	\$716	\$811	\$474
CSQ 48x120 (1 piece)	2	\$10,613	\$11,675	\$12,205	15%	\$121	\$121	\$242	\$716	\$811	\$474
CSQ 48x144 (1 piece)	2	\$12,098	\$13,308	\$13,913	15%	\$121	\$121	\$242	\$716	\$811	\$474
CSQ 60x120 (1 piece)	2	\$12,656	\$13,921	\$14,554	15%	\$121	\$121	\$242	\$716	\$811	\$474
CSQ 60x144 (1 piece)	2	\$14,506	\$15,957	\$16,682	15%	\$121	\$121	\$242	\$716	\$811	\$474

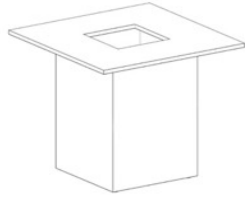

VOLUMA CONFERENCE TABLES - (LAMINATE - PVC EDGE)

SQUARE BASE - VENEER

	# of Bases	Edge Choice: PVC & T-Mold				Laminate Upgrades		Light Weight	OPTIONS				
		T-15 P-10 (self) L-15	L-21 P-12	P-14	PK-2 PK-4 L-23	Laminate Upgrade I ADD	Laminate Upgrade II ADD	Light Weight (PVC only - 1" top) ADD	Grommet - Top Add Per Base	Grommet - Bottom Add Per Base	Two Grommets Add Per Base	Accessory Door 10" x 10" Add Per Base	Accessory Door & Grommet Top Add Per Base
SQUARE (SQR)													
CSQV 42x42	1	\$2,529	\$2,655	\$2,782	\$190	\$506	\$443	\$121	\$121	\$242	\$716	\$811	\$474
CSQV 48x48	1	\$2,798	\$2,937	\$3,077	\$210	\$560	\$490	\$121	\$121	\$242	\$716	\$811	\$474
CSQV 54x54	1	\$2,926	\$3,072	\$3,218	\$219	\$585	N/A	\$121	\$121	\$242	\$716	\$811	\$474
ROUND (RND)													
CSQV 48	1	\$2,660	\$2,793	\$2,926	\$199	\$532	\$465	\$121	\$121	\$242	\$716	\$811	\$474
CSQV 54	1	\$2,938	\$3,085	\$3,232	\$220	\$588	\$514	\$121	\$121	\$242	\$716	\$811	\$474
CSQV 60	1	\$3,076	\$3,230	\$3,384	\$231	\$615	\$538	\$121	\$121	\$242	\$716	\$811	\$474
CSQV 72	1	\$3,843	\$4,035	\$4,227	\$288	\$769	\$673	\$121	\$121	\$242	\$716	\$811	\$474
RECTANGLE (REC)													
CSQV 42x96	2	\$4,985	\$5,235	\$5,484	\$374	\$997	\$872	\$121	\$121	\$242	\$716	\$811	\$474
CSQV 48x96	2	\$5,099	\$5,354	\$5,609	\$382	\$1,020	\$892	\$121	\$121	\$242	\$716	\$811	\$474
CSQV 48x120 (1 piece)	2	\$5,342	\$5,609	\$5,876	\$401	\$1,068	\$935	\$121	\$121	\$242	\$716	\$811	\$474
CSQV 48x144 (1 piece)	2	\$5,584	\$5,864	\$6,143	\$419	\$1,117	\$977	\$121	\$121	\$242	\$716	\$811	\$474
CSQV 48x168 (2 pieces)	3	\$7,797	\$8,187	\$8,577	\$585	\$1,559	\$1,364	\$121	\$121	\$242	\$716	\$811	\$474
CSQV 48x192 (2 pieces)	3	\$8,040	\$8,442	\$8,844	\$603	\$1,608	\$1,407	\$121	\$121	\$242	\$716	\$811	\$474
CSQV 60x120 (1 piece)	2	\$5,930	\$6,226	\$6,523	\$445	\$1,186	\$1,038	\$121	\$121	\$242	\$716	\$811	\$474
CSQV 60x144 (1 piece)	2	\$6,226	\$6,537	\$6,848	\$467	\$1,245	\$1,089	\$121	\$121	\$242	\$716	\$811	\$474
CSQV 60x168 (2 pieces)	3	\$8,645	\$9,077	\$9,509	\$648	\$1,729	\$1,513	\$121	\$121	\$242	\$716	\$811	\$474
CSQV 60x192 (2 pieces)	3	\$8,941	\$9,388	\$9,835	\$671	\$1,788	\$1,565	\$121	\$121	\$242	\$716	\$811	\$474
CSQV 60x240 (2 pieces)	4	\$11,656	\$12,239	\$12,821	\$874	\$2,331	\$2,040	\$121	\$121	\$242	\$716	\$811	\$474
ARC RECTANGLE (ARC REC)													
CSQV 42x96	2	\$5,180	\$5,439	\$5,698	\$389	\$1,036	\$907	\$121	\$121	\$242	\$716	\$811	\$474
CSQV 48x96	2	\$5,300	\$5,565	\$5,830	\$397	\$1,060	\$927	\$121	\$121	\$242	\$716	\$811	\$474
CSQV 48x120 (1 piece)	2	\$5,555	\$5,832	\$6,110	\$417	\$1,111	\$972	\$121	\$121	\$242	\$716	\$811	\$474
CSQV 48x144 (1 piece)	2	\$5,809	\$6,100	\$6,390	\$436	\$1,162	\$1,017	\$121	\$121	\$242	\$716	\$811	\$474
CSQV 48x168 (2 pieces)	3	\$8,106	\$8,511	\$8,916	\$608	\$1,621	\$1,418	\$121	\$121	\$242	\$716	\$811	\$474
CSQV 48x192 (2 pieces)	3	\$8,360	\$8,778	\$9,196	\$627	\$1,672	\$1,463	\$121	\$121	\$242	\$716	\$811	\$474
CSQV 60x120 (1 piece)	2	\$6,172	\$6,481	\$6,789	\$463	\$1,234	\$1,080	\$121	\$121	\$242	\$716	\$811	\$474
CSQV 60x144 (1 piece)	2	\$6,483	\$6,807	\$7,131	\$486	\$1,297	\$1,134	\$121	\$121	\$242	\$716	\$811	\$474
CSQV 60x168 (2 pieces)	3	\$8,996	\$9,446	\$9,895	\$675	\$1,799	\$1,574	\$121	\$121	\$242	\$716	\$811	\$474
CSQV 60x192 (2 pieces)	3	\$9,306	\$9,772	\$10,237	\$698	\$1,861	\$1,629	\$121	\$121	\$242	\$716	\$811	\$474
CSQV 60x240 (2 pieces)	4	\$11,047	\$11,599	\$12,151	\$829	\$2,209	\$1,933	\$121	\$121	\$242	\$716	\$811	\$474
RACETRACK (RAC)													

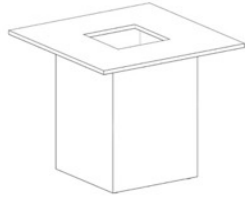

VOLUMA CONFERENCE TABLES - (LAMINATE - PVC EDGE)

SQUARE BASE - VENEER

	# of Bases	Edge Choice: PVC & T-Mold				Laminate Upgrades		Light Weight	OPTIONS					SPECIAL HEIGHT
		T-15 P-10 (self) L-15	L-21 P-12	P-14	PK-2 PK-4 L-23	Laminate Upgrade I ADD	Laminate Upgrade II ADD	Light Weight (PVC only - 1" top) ADD	Grommet - Top Add Per Base	Grommet - Bottom Add Per Base	Two Grommets Add Per Base	Accessory Door 10"x10" Add Per Base	Accessory Door & Grommet Top Add Per Base	
CSQV 42x84	2	\$4,962	\$5,210	\$5,458	\$372	\$992	\$868	\$121	\$121	\$242	\$716	\$811	\$474	
CSQV 42x96	2	\$5,070	\$5,324	\$5,577	\$380	\$1,014	\$887	\$121	\$121	\$242	\$716	\$811	\$474	
CSQV 48x96	2	\$5,184	\$5,443	\$5,702	\$389	\$1,037	\$907	\$121	\$121	\$242	\$716	\$811	\$474	
CSQV 48x120 (1 piece)	2	\$5,427	\$5,698	\$5,969	\$407	\$1,085	\$950	\$121	\$121	\$242	\$716	\$811	\$474	
CSQV 48x144 (1 piece)	2	\$4,186	\$4,396	\$4,605	\$314	\$837	\$733	\$121	\$121	\$242	\$716	\$811	\$474	
CSQV 60x144 (1 piece)	2	\$6,310	\$6,626	\$6,941	\$473	\$1,262	\$1,104	\$121	\$121	\$242	\$716	\$811	\$474	
CSQV 60x192 (2 pieces)	3	\$9,026	\$9,477	\$9,928	\$677	\$1,805	\$1,579	\$121	\$121	\$242	\$716	\$811	\$474	
CSQV 60x240 (2 pieces)	4	\$11,741	\$12,328	\$12,915	\$881	\$2,348	\$2,055	\$121	\$121	\$242	\$716	\$811	\$474	
BOAT (BOT)														
CSQV 42x54x120 (1 piece)	2	\$5,567	\$5,845	\$6,124	\$418	\$1,113	\$974	\$121	\$121	\$242	\$716	\$811	\$474	
CSQV 42x54x144 (1 piece)	2	\$5,836	\$6,128	\$6,420	\$438	\$1,167	\$1,021	\$121	\$121	\$242	\$716	\$811	\$474	
CSQV 48x60x192 (2 pieces)	3	\$9,026	\$9,477	\$9,928	\$677	\$1,805	\$1,579	\$121	\$121	\$242	\$716	\$811	\$474	
CSQV 48x60x240 (2 pieces)	3	\$9,617	\$10,098	\$10,579	\$721	\$1,923	\$1,683	\$121	\$121	\$242	\$716	\$811	\$474	
ARC BOAT (ARCBOT)														
CSQV 42x54x120 (1 piece)	2	\$5,791	\$6,081	\$6,370	\$434	\$1,158	\$1,013	\$121	\$121	\$242	\$716	\$811	\$474	
CSQV 42x54x144 (1 piece)	2	\$6,074	\$6,377	\$6,681	\$456	\$1,215	\$1,063	\$121	\$121	\$242	\$716	\$811	\$474	
CSQV 48x60x192 (2 pieces)	3	\$9,396	\$9,865	\$10,335	\$705	\$1,879	\$1,644	\$121	\$121	\$242	\$716	\$811	\$474	
CSQV 48x60x240 (2 pieces)	3	\$10,017	\$10,517	\$11,018	\$751	\$2,003	\$1,753	\$121	\$121	\$242	\$716	\$811	\$474	
OVAL (OVL)														
CSQV 42x96	2	\$5,070	\$5,324	\$5,577	\$380	\$1,014	\$887	\$121	\$121	\$242	\$716	\$811	\$474	
CSQV 48x96	2	\$5,184	\$5,443	\$5,702	\$389	\$1,037	\$907	\$121	\$121	\$242	\$716	\$811	\$474	
CSQV 48x120 (1 piece)	2	\$5,427	\$5,698	\$5,969	\$407	\$1,085	\$950	\$121	\$121	\$242	\$716	\$811	\$474	
CSQV 48x144 (1 piece)	2	\$5,669	\$5,953	\$6,236	\$425	\$1,134	\$992	\$121	\$121	\$242	\$716	\$811	\$474	
CSQV 60x120 (1 piece)	2	\$6,015	\$6,315	\$6,616	\$451	\$1,203	\$1,053	\$121	\$121	\$242	\$716	\$811	\$474	
CSQV 60x144 (1 piece)	2	\$6,310	\$6,626	\$6,941	\$473	\$1,262	\$1,104	\$121	\$121	\$242	\$716	\$811	\$474	

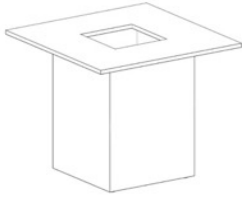

VOLUMA CONFERENCE TABLES - (LAMINATE - WOOD EDGE)





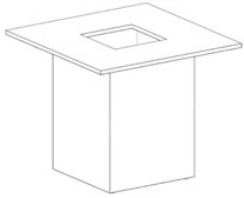



SQUARE BASE - VENEER

	# of Bases	Edge Choice: Wood (Red Oak & Maple)			Wood Upgrade	OPTIONS					
		W-12	W-23 W-18 W-16	W-19 W-17 W-32	Upgrade: Walnut / Mahogany / Cherry	Grommet - Top	Grommet - Bottom	Two Grommets	Accessory Door 10" x 10"	Accessory Door & Grommet Top	SPECIAL HEIGHT
					ADD	Add Per Base	Add Per Base	Add Per Base	Add Per Base	Add Per Base	ADD
SQUARE (SQR)											
CSQV 42x42	1	\$4,742	\$5,690	\$6,323	15%	\$121	\$121	\$242	\$716	\$811	\$474
CSQV 48x48	1	\$5,245	\$6,294	\$6,994	15%	\$121	\$121	\$242	\$716	\$811	\$474
CSQV 54x54	1	\$5,485	\$6,582	\$7,314	15%	\$121	\$121	\$242	\$716	\$811	\$474
ROUND (RND)											
CSQV 48	1	\$4,987	\$5,985	\$6,650	15%	\$121	\$121	\$242	\$716	\$811	\$474
CSQV 54	1	\$5,510	\$6,611	\$7,346	15%	\$121	\$121	\$242	\$716	\$811	\$474
CSQV 60	1	\$5,768	\$6,922	\$7,691	15%	\$121	\$121	\$242	\$716	\$811	\$474
CSQV 72	1	\$7,206	\$8,647	\$9,608	15%	\$121	\$121	\$242	\$716	\$811	\$474
RECTANGLE (REC)											
CSQV 42x96	2	\$9,347	\$11,217	\$12,463	15%	\$121	\$121	\$242	\$716	\$811	\$474
CSQV 48x96	2	\$9,561	\$11,473	\$12,747	15%	\$121	\$121	\$242	\$716	\$811	\$474
CSQV 48x120 (1 piece)	2	\$10,016	\$12,019	\$13,354	15%	\$121	\$121	\$242	\$716	\$811	\$474
CSQV 48x144 (1 piece)	2	\$10,471	\$12,565	\$13,961	15%	\$121	\$121	\$242	\$716	\$811	\$474
CSQV 48x168 (2 pieces)	3	\$14,619	\$17,543	\$19,492	15%	\$121	\$121	\$242	\$716	\$811	\$474
CSQV 48x192 (2 pieces)	3	\$15,074	\$18,089	\$20,099	15%	\$121	\$121	\$242	\$716	\$811	\$474
CSQV 60x120 (1 piece)	2	\$11,118	\$13,342	\$14,824	15%	\$121	\$121	\$242	\$716	\$811	\$474
CSQV 60x144 (1 piece)	2	\$11,673	\$14,007	\$15,564	15%	\$121	\$121	\$242	\$716	\$811	\$474
CSQV 60x168 (2 pieces)	3	\$16,209	\$19,451	\$21,612	15%	\$121	\$121	\$242	\$716	\$811	\$474
CSQV 60x192 (2 pieces)	3	\$16,764	\$20,116	\$22,352	15%	\$121	\$121	\$242	\$716	\$811	\$474
CSQV 60x240 (2 pieces)	4	\$21,854	\$26,225	\$29,139	15%	\$121	\$121	\$242	\$716	\$811	\$474
ARC RECTANGLE (ARC REC)											
CSQV 42x96	2	\$9,713	\$11,656	\$12,951	15%	\$121	\$121	\$242	\$716	\$811	\$474
CSQV 48x96	2	\$9,937	\$11,924	\$13,249	15%	\$121	\$121	\$242	\$716	\$811	\$474
CSQV 48x120 (1 piece)	2	\$10,415	\$12,498	\$13,887	15%	\$121	\$121	\$242	\$716	\$811	\$474
CSQV 48x144 (1 piece)	2	\$10,893	\$13,071	\$14,524	15%	\$121	\$121	\$242	\$716	\$811	\$474
CSQV 48x168 (2 pieces)	3	\$15,198	\$18,237	\$20,264	15%	\$121	\$121	\$242	\$716	\$811	\$474
CSQV 48x192 (2 pieces)	3	\$15,676	\$18,811	\$20,901	15%	\$121	\$121	\$242	\$716	\$811	\$474
CSQV 60x120 (1 piece)	2	\$11,573	\$13,887	\$15,430	15%	\$121	\$121	\$242	\$716	\$811	\$474
CSQV 60x144 (1 piece)	2	\$12,155	\$14,586	\$16,207	15%	\$121	\$121	\$242	\$716	\$811	\$474
CSQV 60x168 (2 pieces)	3	\$16,867	\$20,241	\$22,490	15%	\$121	\$121	\$242	\$716	\$811	\$474
CSQV 60x192 (2 pieces)	3	\$17,449	\$20,939	\$23,266	15%	\$121	\$121	\$242	\$716	\$811	\$474
CSQV 60x240 (2 pieces)	4	\$20,713	\$24,855	\$27,617	15%	\$121	\$121	\$242	\$716	\$811	\$474
RACETRACK (RAC)											



VOLUMA CONFERENCE TABLES - (LAMINATE - WOOD EDGE



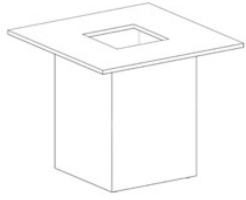

SQUARE BASE - VENEER

	# of Bases	Edge Choice: Wood (Red Oak & Maple)			Wood Upgrade	OPTIONS					
		 W-12	 W-23	 W-19	Upgrade: Walnut / Mahogany / Cherry	 Grommet - Top	 Grommet - Bottom	 Two Grommets	 Accessory Door 10"x10"	 Accessory Door & Grommet Top	SPECIAL HEIGHT
					ADD	Add Per Base	Add Per Base	Add Per Base	Add Per Base	Add Per Base	ADD
CSQV 42x84	2	\$9,304	\$11,165	\$12,405	15%	\$121	\$121	\$242	\$716	\$811	\$474
CSQV 42x96	2	\$9,507	\$11,408	\$12,675	15%	\$121	\$121	\$242	\$716	\$811	\$474
CSQV 48x96	2	\$9,720	\$11,664	\$12,960	15%	\$121	\$121	\$242	\$716	\$811	\$474
CSQV 48x120 (1 piece)	2	\$10,175	\$12,210	\$13,567	15%	\$121	\$121	\$242	\$716	\$811	\$474
CSQV 48x144 (1 piece)	2	\$7,849	\$9,419	\$10,466	15%	\$121	\$121	\$242	\$716	\$811	\$474
CSQV 60x144 (1 piece)	2	\$11,832	\$14,198	\$15,776	15%	\$121	\$121	\$242	\$716	\$811	\$474
CSQV 60x192 (2 pieces)	3	\$16,923	\$20,307	\$22,564	15%	\$121	\$121	\$242	\$716	\$811	\$474
CSQV 60x240 (2 pieces)	4	\$22,014	\$26,416	\$29,352	15%	\$121	\$121	\$242	\$716	\$811	\$474
BOAT (BOT)											
CSQV 42x54x120 (1 piece)	2	\$10,438	\$12,525	\$13,917	15%	\$121	\$121	\$242	\$716	\$811	\$474
CSQV 42x54x144 (1 piece)	2	\$10,943	\$13,131	\$14,590	15%	\$121	\$121	\$242	\$716	\$811	\$474
CSQV 48x60x192 (2 pieces)	3	\$16,923	\$20,307	\$22,564	15%	\$121	\$121	\$242	\$716	\$811	\$474
CSQV 48x60x240 (2 pieces)	3	\$18,032	\$21,638	\$24,043	15%	\$121	\$121	\$242	\$716	\$811	\$474
ARC BOAT (ARCBOT)											
CSQV 42x54x120 (1 piece)	2	\$10,858	\$13,030	\$14,478	15%	\$121	\$121	\$242	\$716	\$811	\$474
CSQV 42x54x144 (1 piece)	2	\$11,388	\$13,666	\$15,184	15%	\$121	\$121	\$242	\$716	\$811	\$474
CSQV 48x60x192 (2 pieces)	3	\$17,617	\$21,140	\$23,489	15%	\$121	\$121	\$242	\$716	\$811	\$474
CSQV 48x60x240 (2 pieces)	3	\$18,781	\$22,537	\$25,042	15%	\$121	\$121	\$242	\$716	\$811	\$474
OVAL (OVL)											
CSQV 42x96	2	\$9,507	\$11,408	\$12,675	15%	\$121	\$121	\$242	\$716	\$811	\$474
CSQV 48x96	2	\$9,720	\$11,664	\$12,960	15%	\$121	\$121	\$242	\$716	\$811	\$474
CSQV 48x120 (1 piece)	2	\$10,175	\$12,210	\$13,567	15%	\$121	\$121	\$242	\$716	\$811	\$474
CSQV 48x144 (1 piece)	2	\$10,630	\$12,756	\$14,173	15%	\$121	\$121	\$242	\$716	\$811	\$474
CSQV 60x120 (1 piece)	2	\$11,278	\$13,533	\$15,037	15%	\$121	\$121	\$242	\$716	\$811	\$474
CSQV 60x144 (1 piece)	2	\$11,832	\$14,198	\$15,776	15%	\$121	\$121	\$242	\$716	\$811	\$474



VOLUMA CONFERENCE TABLES - (VENEER)





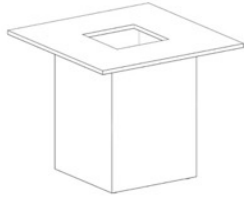













SQUARE BASE - VENEER

	# of Bases	Edge Choice: Wood (Red Oak & Maple)			Wood Upgrade	OPTIONS					
		 V-12	 V-23	 V-19	Upgrade: Walnut / Mahogany / Cherry	Grommet - Top	Grommet - Bottom	Two Grommets	Accessory Door 10" x 10"	Accessory Door & Grommet Top	SPECIAL HEIGHT
		 V-18	 V-17	ADD		Add Per Base	Add Per Base	Add Per Base	Add Per Base	Add Per Base	ADD
SQUARE (SQR)											
CSQV 42x42	1	\$4,579	\$5,037	\$5,266	15%	\$121	\$121	\$242	\$716	\$811	\$474
CSQV 48x48	1	\$5,474	\$6,021	\$6,295	15%	\$121	\$121	\$242	\$716	\$811	\$474
CSQV 54x54	1	\$6,582	\$7,241	\$7,570	15%	\$121	\$121	\$242	\$716	\$811	\$474
ROUND (RND)											
CSQV 48	1	\$4,587	\$5,046	\$5,275	15%	\$121	\$121	\$242	\$716	\$811	\$474
CSQV 54	1	\$5,466	\$5,739	\$6,286	15%	\$121	\$121	\$242	\$716	\$811	\$474
CSQV 60	1	\$6,256	\$6,881	\$7,194	15%	\$121	\$121	\$242	\$716	\$811	\$474
CSQV 72	1	\$8,427	\$9,270	\$9,692	15%	\$121	\$121	\$242	\$716	\$811	\$474
RECTANGLE (REC)											
CSQV 42x96	2	\$8,282	\$9,110	\$9,524	15%	\$121	\$121	\$242	\$716	\$811	\$474
CSQV 48x96	2	\$8,282	\$9,110	\$9,524	15%	\$121	\$121	\$242	\$716	\$811	\$474
CSQV 48x120 (1 piece)	2	\$9,767	\$10,743	\$11,232	15%	\$121	\$121	\$242	\$716	\$811	\$474
CSQV 48x144 (1 piece)	2	\$10,959	\$12,055	\$12,602	15%	\$121	\$121	\$242	\$716	\$811	\$474
CSQV 48x168 (2 pieces)	3	\$14,054	\$15,459	\$16,162	15%	\$121	\$121	\$242	\$716	\$811	\$474
CSQV 48x192 (2 pieces)	3	\$15,246	\$16,771	\$17,533	15%	\$121	\$121	\$242	\$716	\$811	\$474
CSQV 60x120 (1 piece)	2	\$11,582	\$12,741	\$13,320	15%	\$121	\$121	\$242	\$716	\$811	\$474
CSQV 60x144 (1 piece)	2	\$13,074	\$14,382	\$15,035	15%	\$121	\$121	\$242	\$716	\$811	\$474
CSQV 60x168 (2 pieces)	3	\$16,624	\$18,286	\$19,117	15%	\$121	\$121	\$242	\$716	\$811	\$474
CSQV 60x192 (2 pieces)	3	\$18,116	\$19,927	\$20,833	15%	\$121	\$121	\$242	\$716	\$811	\$474
CSQV 60x240 (2 pieces)	4	\$23,165	\$25,481	\$26,639	15%	\$121	\$121	\$242	\$716	\$811	\$474
ARC RECTANGLE (ARC REC)											
CSQV 42x96	2	\$8,656	\$9,522	\$9,955	15%	\$121	\$121	\$242	\$716	\$811	\$474
CSQV 48x96	2	\$8,656	\$9,522	\$9,955	15%	\$121	\$121	\$242	\$716	\$811	\$474
CSQV 48x120 (1 piece)	2	\$10,215	\$11,236	\$11,747	15%	\$121	\$121	\$242	\$716	\$811	\$474
CSQV 48x144 (1 piece)	2	\$11,467	\$12,613	\$13,187	15%	\$121	\$121	\$242	\$716	\$811	\$474
CSQV 48x168 (2 pieces)	3	\$14,697	\$16,166	\$16,901	15%	\$121	\$121	\$242	\$716	\$811	\$474
CSQV 48x192 (2 pieces)	3	\$15,948	\$17,543	\$18,341	15%	\$121	\$121	\$242	\$716	\$811	\$474
CSQV 60x120 (1 piece)	2	\$12,121	\$13,334	\$13,940	15%	\$121	\$121	\$242	\$716	\$811	\$474
CSQV 60x144 (1 piece)	2	\$13,688	\$15,057	\$15,741	15%	\$121	\$121	\$242	\$716	\$811	\$474
CSQV 60x168 (2 pieces)	3	\$17,395	\$19,135	\$20,004	15%	\$121	\$121	\$242	\$716	\$811	\$474
CSQV 60x192 (2 pieces)	3	\$18,961	\$20,858	\$21,806	15%	\$121	\$121	\$242	\$716	\$811	\$474
CSQV 60x240 (2 pieces)	4	\$24,243	\$26,667	\$27,879	15%	\$121	\$121	\$242	\$716	\$811	\$474
RACETRACK (RAC)											



VOLUMA CONFERENCE TABLES - (VENEER)

SQUARE BASE - VENEER

	# of Bases	Edge Choice: Wood (Red Oak & Maple)			Wood Upgrade	OPTIONS					
		 V-12	 V-23	 V-19	Upgrade: Walnut / Mahogany / Cherry	 Grommet - Top	 Grommet - Bottom	 Two Grommets	 Accessory Door 10"x10"	 Accessory Door & Grommet Top	 SPECIAL HEIGHT
					ADD	Add Per Base	Add Per Base	Add Per Base	Add Per Base	Add Per Base	ADD
		 V-18	 V-17			 Grommet - Top	 Grommet - Bottom	 Two Grommets	 Accessory Door 10"x10"	 Accessory Door & Grommet Top	
		 V-16	 V-32								
CSQV 42x84	2	\$11,165	\$12,281	\$12,839	15%	\$121	\$121	\$242	\$716	\$811	\$474
CSQV 42x96	2	\$11,408	\$12,549	\$13,119	15%	\$121	\$121	\$242	\$716	\$811	\$474
CSQV 48x96	2	\$8,816	\$9,698	\$10,138	15%	\$121	\$121	\$242	\$716	\$811	\$474
CSQV 48x120 (1 piece)	2	\$10,300	\$11,331	\$11,846	15%	\$121	\$121	\$242	\$716	\$811	\$474
CSQV 48x144 (1 piece)	2	\$11,493	\$12,642	\$13,216	15%	\$121	\$121	\$242	\$716	\$811	\$474
CSQV 60x144 (1 piece)	2	\$13,608	\$14,969	\$15,649	15%	\$121	\$121	\$242	\$716	\$811	\$474
CSQV 60x192 (2 pieces)	3	\$18,650	\$20,514	\$21,447	15%	\$121	\$121	\$242	\$716	\$811	\$474
CSQV 60x240 (2 pieces)	4	\$23,698	\$26,068	\$27,253	15%	\$121	\$121	\$242	\$716	\$811	\$474
BOAT (BOT)											
CSQV 42x54x120 (1 piece)	2	\$12,525	\$13,778	\$14,404	15%	\$121	\$121	\$242	\$716	\$811	\$474
CSQV 42x54x144 (1 piece)	2	\$13,131	\$14,444	\$15,101	15%	\$121	\$121	\$242	\$716	\$811	\$474
CSQV 48x60x192 (2 pieces)	3	\$17,765	\$19,541	\$20,429	15%	\$121	\$121	\$242	\$716	\$811	\$474
CSQV 48x60x240 (2 pieces)	3	\$20,653	\$22,719	\$23,751	15%	\$121	\$121	\$242	\$716	\$811	\$474
ARC BOAT (ARCBOT)											
CSQV 42x54x120 (1 piece)	2	\$13,030	\$14,333	\$14,984	15%	\$121	\$121	\$242	\$716	\$811	\$474
CSQV 42x54x144 (1 piece)	2	\$13,666	\$15,032	\$15,716	15%	\$121	\$121	\$242	\$716	\$811	\$474
CSQV 48x60x192 (2 pieces)	3	\$18,593	\$20,452	\$21,382	15%	\$121	\$121	\$242	\$716	\$811	\$474
CSQV 48x60x240 (2 pieces)	3	\$21,626	\$23,789	\$24,870	15%	\$121	\$121	\$242	\$716	\$811	\$474
OVAL (OVL)											
CSQV 42x96	2	\$9,445	\$10,389	\$10,862	15%	\$121	\$121	\$242	\$716	\$811	\$474
CSQV 48x96	2	\$9,445	\$10,389	\$10,862	15%	\$121	\$121	\$242	\$716	\$811	\$474
CSQV 48x120 (1 piece)	2	\$11,215	\$12,336	\$12,897	15%	\$121	\$121	\$242	\$716	\$811	\$474
CSQV 48x144 (1 piece)	2	\$12,699	\$13,969	\$14,604	15%	\$121	\$121	\$242	\$716	\$811	\$474
CSQV 60x120 (1 piece)	2	\$13,396	\$14,735	\$15,405	15%	\$121	\$121	\$242	\$716	\$811	\$474
CSQV 60x144 (1 piece)	2	\$15,246	\$16,771	\$17,533	15%	\$121	\$121	\$242	\$716	\$811	\$474

VOLUMA CONFERENCE TABLES - (LAMINATE - PVC EDGE)

HALF CYLINDER BASE - LAMINATE











	# of Bases	Edge Choice: PVC & T-Mold				Laminate Upgrades		Light Weight	OPTIONS					
		T-15 P-10 (self) L-15	L-21 P-12	P-14	PK-2 PK-4 L-23	Laminate Upgrade I ADD	Laminate Upgrade II ADD	Light Weight (PVC only - 1" top) ADD	Grommet - Top Add Per Base	Grommet - Bottom Add Per Base	Two Grommets Add Per Base	Accessory Door 10" x 10" Add Per Base	Accessory Door & Grommet Top Add Per Base	SPECIAL HEIGHT ADD
RECTANGLE (REC)														
CH 36x96	2	\$3,393	\$3,562	\$3,732	\$254	\$679	\$594	\$121	\$121	\$242	\$716	\$811	\$474	
CH 36x120 (1 piece)	2	\$3,582	\$3,761	\$3,941	\$269	\$716	\$627	\$121	\$121	\$242	\$716	\$811	\$474	
CH 42x96	2	\$3,506	\$3,682	\$3,857	\$263	\$701	\$614	\$121	\$121	\$242	\$716	\$811	\$474	
CH 42x120 (1 piece)	2	\$3,723	\$3,909	\$4,095	\$279	\$745	\$651	\$121	\$121	\$242	\$716	\$811	\$474	
CH 48x96	2	\$3,620	\$3,801	\$3,982	\$272	\$724	\$634	\$121	\$121	\$242	\$716	\$811	\$474	
CH 48x120 (1 piece)	2	\$3,863	\$4,056	\$4,249	\$290	\$773	\$676	\$121	\$121	\$242	\$716	\$811	\$474	
CH 60x96	2	\$4,067	\$4,271	\$4,474	\$305	\$813	\$712	\$121	\$121	\$242	\$716	\$811	\$474	
CH 60x120 (1 piece)	2	\$4,363	\$4,581	\$4,799	\$327	\$873	\$764	\$121	\$121	\$242	\$716	\$811	\$474	
ARC RECTANGLE (ARCREC)														
CH 36x96	2	\$3,562	\$3,740	\$3,919	\$267	\$712	\$623	\$121	\$121	\$242	\$716	\$811	\$474	
CH 36x120 (1 piece)	2	\$3,761	\$3,950	\$4,138	\$282	\$752	\$658	\$121	\$121	\$242	\$716	\$811	\$474	
CH 42x96	2	\$3,682	\$3,866	\$4,050	\$276	\$736	\$644	\$121	\$121	\$242	\$716	\$811	\$474	
CH 42x120 (1 piece)	2	\$3,909	\$4,104	\$4,300	\$293	\$782	\$684	\$121	\$121	\$242	\$716	\$811	\$474	
CH 48x96	2	\$3,801	\$3,991	\$4,181	\$285	\$760	\$665	\$121	\$121	\$242	\$716	\$811	\$474	
CH 48x120 (1 piece)	2	\$4,056	\$4,259	\$4,462	\$304	\$811	\$710	\$121	\$121	\$242	\$716	\$811	\$474	
CH 60x96	2	\$4,271	\$4,484	\$4,698	\$320	\$854	\$747	\$121	\$121	\$242	\$716	\$811	\$474	
CH 60x120 (1 piece)	2	\$4,581	\$4,810	\$5,039	\$344	\$916	\$802	\$121	\$121	\$242	\$716	\$811	\$474	
RACETRACK (RAC)														
CH 42x96	2	\$3,591	\$3,771	\$3,950	\$269	\$718	\$628	\$121	\$121	\$242	\$716	\$811	\$474	
CH 42x120 (1 piece)	2	\$3,807	\$3,998	\$4,188	\$286	\$761	\$666	\$121	\$121	\$242	\$716	\$811	\$474	
CH 48x96	2	\$3,705	\$3,890	\$4,076	\$278	\$741	\$648	\$121	\$121	\$242	\$716	\$811	\$474	
CH 48x120 (1 piece)	2	\$3,948	\$4,145	\$4,342	\$296	\$790	\$691	\$121	\$121	\$242	\$716	\$811	\$474	
BOAT (BOT)														
CH 42x54x120 (1 piece)	2	\$4,088	\$4,292	\$4,497	\$307	\$818	\$715	\$121	\$121	\$242	\$716	\$811	\$474	
ARC BOAT (ARCBOT)														
CH 42x54x120 (1 piece)	2	\$4,292	\$4,507	\$4,722	\$322	\$858	\$751	\$121	\$121	\$242	\$716	\$811	\$474	
OVAL (OVL)														
CH 42x96	2	\$3,591	\$3,771	\$3,950	\$269	\$718	\$628	\$121	\$121	\$242	\$716	\$811	\$474	
CH 48x96	2	\$3,705	\$3,890	\$4,076	\$278	\$741	\$648	\$121	\$121	\$242	\$716	\$811	\$474	
CH 48x120 (1 piece)	2	\$3,948	\$4,145	\$4,342	\$296	\$790	\$691	\$121	\$121	\$242	\$716	\$811	\$474	
CH 60x120 (1 piece)	2	\$4,448	\$4,670	\$4,893	\$334	\$890	\$778	\$121	\$121	\$242	\$716	\$811	\$474	

VOLUMA CONFERENCE TABLES - (LAMINATE - WOOD EDG

HALF CYLINDER BASE - LAMINATE









	# of Bases	Edge Choice: Wood (Red Oak & Maple)			Wood Upgrade	OPTIONS					SPECIAL HEIGHT
		W-12	W-23	W-19	Upgrade: Walnut / Mahogany / Cherry	Grommet - Top	Grommet - Bottom	Two Grommets	Accessory Door 10" x 10"	Accessory Door & Grommet Top	
											
					ADD	Add Per Base	Add Per Base	Add Per Base	Add Per Base	Add Per Base	ADD
RECTANGLE (REC)											
CH 36x96	2	\$5,089	\$5,937	\$6,785	15%	\$121	\$121	\$242	\$716	\$811	\$474
CH 36x120 (1 piece)	2	\$5,374	\$6,269	\$7,165	15%	\$121	\$121	\$242	\$716	\$811	\$474
CH 42x96	2	\$6,574	\$7,889	\$8,766	15%	\$121	\$121	\$242	\$716	\$811	\$474
CH 42x120 (1 piece)	2	N/A	N/A	N/A	N/A	\$121	\$121	\$242	\$716	\$811	\$474
CH 48x96	2	\$6,788	\$8,145	\$9,050	15%	\$121	\$121	\$242	\$716	\$811	\$474
CH 48x120 (1 piece)	2	\$7,243	\$8,691	\$9,657	15%	\$121	\$121	\$242	\$716	\$811	\$474
CH 60x96	2	\$7,626	\$9,151	\$10,168	15%	\$121	\$121	\$242	\$716	\$811	\$474
CH 60x120 (1 piece)	2	\$8,181	\$9,817	\$10,907	15%	\$121	\$121	\$242	\$716	\$811	\$474
ARC RECTANGLE (ARC REC)											
CH 36x96	2	\$6,679	\$8,015	\$8,906	15%	\$121	\$121	\$242	\$716	\$811	\$474
CH 36x120 (1 piece)	2	\$7,053	\$8,463	\$9,404	15%	\$121	\$121	\$242	\$716	\$811	\$474
CH 42x96	2	\$6,903	\$8,284	\$9,204	15%	\$121	\$121	\$242	\$716	\$811	\$474
CH 42x120 (1 piece)	2	\$7,329	\$8,795	\$9,772	15%	\$121	\$121	\$242	\$716	\$811	\$474
CH 48x96	2	\$7,127	\$8,552	\$9,503	15%	\$121	\$121	\$242	\$716	\$811	\$474
CH 48x120 (1 piece)	2	\$7,605	\$9,126	\$10,140	15%	\$121	\$121	\$242	\$716	\$811	\$474
CH 60x96	2	\$8,007	\$9,609	\$10,677	15%	\$121	\$121	\$242	\$716	\$811	\$474
CH 60x120 (1 piece)	2	\$8,590	\$10,308	\$11,453	15%	\$121	\$121	\$242	\$716	\$811	\$474
RACETRACK (RAC)											
CH 42x96	2	\$6,734	\$8,080	\$8,978	15%	\$121	\$121	\$242	\$716	\$811	\$474
CH 42x120 (1 piece)	2	\$7,139	\$8,567	\$9,519	15%	\$121	\$121	\$242	\$716	\$811	\$474
CH 48x96	2	\$6,947	\$8,336	\$9,263	15%	\$121	\$121	\$242	\$716	\$811	\$474
CH 48x120 (1 piece)	2	\$7,402	\$8,882	\$9,869	15%	\$121	\$121	\$242	\$716	\$811	\$474
BOAT (BOT)											
CH 42x54x120 (1 piece)	2	\$7,665	\$9,198	\$10,220	15%	\$121	\$121	\$242	\$716	\$811	\$474
ARC BOAT (ARCBOT)											
CH 42x54x120 (1 piece)	2	\$8,048	\$9,658	\$10,731	15%	\$121	\$121	\$242	\$716	\$811	\$474
OVAL (OVL)											
CH 42x96	2	\$6,734	\$8,080	\$8,978	15%	\$121	\$121	\$242	\$716	\$811	\$474
CH 48x96	2	\$6,947	\$8,336	\$9,263	15%	\$121	\$121	\$242	\$716	\$811	\$474
CH 48x120 (1 piece)	2	\$7,402	\$8,882	\$9,869	15%	\$121	\$121	\$242	\$716	\$811	\$474
CH 60x120 (1 piece)	2	\$8,340	\$10,008	\$11,120	15%	\$121	\$121	\$242	\$716	\$811	\$474

VOLUMA CONFERENCE TABLES - (VENEER)

HALF CYLINDER BASE - LAMINATE



	# of Bases	Edge Choice: Wood (Red Oak & Maple)			Wood Upgrade	OPTIONS					
		 V-12	 V-23  V-18  V-16	 V-19  V-17  V-32	Upgrade: Walnut / Mahogany / Cherry	Grommet - Top	Grommet - Bottom	Two Grommets	Accessory Door 10" x10"	Accessory Door & Grommet Top	SPECIAL HEIGHT
					ADD	Add Per Base	Add Per Base	Add Per Base	Add Per Base	Add Per Base	ADD
RECTANGLE (REC)											
CH 36x96	2	\$7,066	\$7,772	\$8,126	15%	\$121	\$121	\$242	\$716	\$811	\$474
CH 36x120 (1 piece)	2	\$7,066	\$7,772	\$8,126	15%	\$121	\$121	\$242	\$716	\$811	\$474
CH 42x96	2	\$7,066	\$7,772	\$8,126	15%	\$121	\$121	\$242	\$716	\$811	\$474
CH 42x120 (1 piece)	2	\$7,066	\$7,772	\$8,126	N/A	\$121	\$121	\$242	\$716	\$811	\$474
CH 48x96	2	\$7,066	\$7,772	\$8,126	15%	\$121	\$121	\$242	\$716	\$811	\$474
CH 48x120 (1 piece)	2	\$8,550	\$9,405	\$9,833	15%	\$121	\$121	\$242	\$716	\$811	\$474
CH 60x96	2	\$8,782	\$9,660	\$10,099	15%	\$121	\$121	\$242	\$716	\$811	\$474
CH 60x120 (1 piece)	2	\$10,273	\$11,301	\$11,814	15%	\$121	\$121	\$242	\$716	\$811	\$474
ARC RECTANGLE (ARC REC)											
CH 36x96	2	\$7,419	\$8,161	\$8,532	15%	\$121	\$121	\$242	\$716	\$811	\$474
CH 36x120 (1 piece)	2	\$7,419	\$8,161	\$8,532	15%	\$121	\$121	\$242	\$716	\$811	\$474
CH 42x96	2	\$7,419	\$8,161	\$8,532	15%	\$121	\$121	\$242	\$716	\$811	\$474
CH 42x120 (1 piece)	2	\$8,978	\$9,876	\$10,325	15%	\$121	\$121	\$242	\$716	\$811	\$474
CH 48x96	2	\$7,419	\$8,161	\$8,532	15%	\$121	\$121	\$242	\$716	\$811	\$474
CH 48x120 (1 piece)	2	\$8,978	\$9,876	\$10,325	15%	\$121	\$121	\$242	\$716	\$811	\$474
CH 60x96	2	\$9,221	\$10,143	\$10,604	15%	\$121	\$121	\$242	\$716	\$811	\$474
CH 60x120 (1 piece)	2	\$10,787	\$11,866	\$12,405	15%	\$121	\$121	\$242	\$716	\$811	\$474
RACETRACK (RAC)											
CH 42x96	2	\$7,183	\$7,901	\$8,260	15%	\$121	\$121	\$242	\$716	\$811	\$474
CH 42x120 (1 piece)	2	\$7,615	\$8,376	\$8,757	15%	\$121	\$121	\$242	\$716	\$811	\$474
CH 48x96	2	\$7,600	\$8,360	\$8,740	15%	\$121	\$121	\$242	\$716	\$811	\$474
CH 48x120 (1 piece)	2	\$9,084	\$9,993	\$10,447	15%	\$121	\$121	\$242	\$716	\$811	\$474
BOAT (BOT)											
CH 42x54x120 (1 piece)	2	\$8,176	\$8,994	\$9,402	15%	\$121	\$121	\$242	\$716	\$811	\$474
ARC BOAT (ARCBOT)											
CH 42x54x120 (1 piece)	2	\$8,585	\$9,443	\$9,872	15%	\$121	\$121	\$242	\$716	\$811	\$474
OVAL (OVL)											
CH 42x96	2	\$8,229	\$9,051	\$9,463	15%	\$121	\$121	\$242	\$716	\$811	\$474
CH 48x96	2	\$8,229	\$9,051	\$9,463	15%	\$121	\$121	\$242	\$716	\$811	\$474
CH 48x120 (1 piece)	2	\$9,998	\$10,998	\$11,498	15%	\$121	\$121	\$242	\$716	\$811	\$474
CH 60x120 (1 piece)	2	\$12,087	\$13,296	\$13,900	15%	\$121	\$121	\$242	\$716	\$811	\$474

VOLUMA CONFERENCE TABLES - (LAMINATE - PVC EDGE)

HALF CYLINDER BASE - VENEER

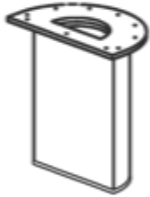







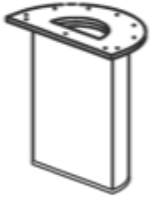





	# of Bases	Edge Choice: PVC & T-Mold				Laminate Upgrades		Light Weight	OPTIONS					SPECIAL HEIGHT
		T-15	L-21	P-14	PK-2	Laminate Upgrade I	Laminate Upgrade II	Light Weight (PVC only - 1" top)	Grommet - Top	Grommet - Bottom	Two Grommets	Accessory Door 10" x 10"	Accessory Door & Grommet Top	
		P-10 (self)	P-12	PK-4	ADD	ADD	ADD	Add Per Base	Add Per Base	Add Per Base	Add Per Base	Add Per Base	ADD	
RECTANGLE (REC)														
CHV 36x96	2	\$4,272	\$4,485	\$4,699	\$320	\$854	\$748	\$121	\$121	\$242	\$716	\$811	\$474	
CHV 36x120 (1 piece)	2	\$4,461	\$4,684	\$4,907	\$335	\$892	\$781	\$121	\$121	\$242	\$716	\$811	\$474	
CHV 42x96	2	\$4,385	\$4,604	\$4,824	\$329	\$877	\$767	\$121	\$121	\$242	\$716	\$811	\$474	
CHV 42x120 (1 piece)	2	\$4,601	\$4,831	\$5,062	\$345	\$920	\$805	\$121	\$121	\$242	\$716	\$811	\$474	
CHV 48x96	2	\$4,499	\$4,724	\$4,949	\$337	\$900	\$787	\$121	\$121	\$242	\$716	\$811	\$474	
CHV 48x120 (1 piece)	2	\$4,742	\$4,979	\$5,216	\$356	\$948	\$830	\$121	\$121	\$242	\$716	\$811	\$474	
CHV 60x96	2	\$4,975	\$5,224	\$5,473	\$373	\$995	\$871	\$121	\$121	\$242	\$716	\$811	\$474	
CHV 60x120 (1 piece)	2	\$5,271	\$5,535	\$5,798	\$395	\$1,054	\$922	\$121	\$121	\$242	\$716	\$811	\$474	
ARC RECTANGLE (ARCREC)														
CHV 36x96	2	\$4,485	\$4,709	\$4,934	\$336	\$897	\$785	\$121	\$121	\$242	\$716	\$811	\$474	
CHV 36x120 (1 piece)	2	\$4,684	\$4,918	\$5,153	\$351	\$937	\$820	\$121	\$121	\$242	\$716	\$811	\$474	
CHV 42x96	2	\$4,604	\$4,835	\$5,065	\$345	\$921	\$806	\$121	\$121	\$242	\$716	\$811	\$474	
CHV 42x120 (1 piece)	2	\$4,831	\$5,073	\$5,315	\$362	\$966	\$846	\$121	\$121	\$242	\$716	\$811	\$474	
CHV 48x96	2	\$4,724	\$4,960	\$5,196	\$354	\$945	\$827	\$121	\$121	\$242	\$716	\$811	\$474	
CHV 48x120 (1 piece)	2	\$4,979	\$5,228	\$5,477	\$373	\$996	\$871	\$121	\$121	\$242	\$716	\$811	\$474	
CHV 60x96	2	\$5,224	\$5,485	\$5,747	\$392	\$1,045	\$914	\$121	\$121	\$242	\$716	\$811	\$474	
CHV 60x120 (1 piece)	2	\$5,535	\$5,811	\$6,088	\$415	\$1,107	\$969	\$121	\$121	\$242	\$716	\$811	\$474	
RACETRACK (RAC)														
CHV 42x96	2	\$4,470	\$4,694	\$4,917	\$335	\$894	\$782	\$121	\$121	\$242	\$716	\$811	\$474	
CHV 42x120 (1 piece)	2	\$4,686	\$4,921	\$5,155	\$351	\$937	\$820	\$121	\$121	\$242	\$716	\$811	\$474	
CHV 48x96	2	\$4,584	\$4,813	\$5,042	\$344	\$917	\$802	\$121	\$121	\$242	\$716	\$811	\$474	
CHV 48x120 (1 piece)	2	\$4,827	\$5,068	\$5,309	\$362	\$965	\$845	\$121	\$121	\$242	\$716	\$811	\$474	
BOAT (BOT)														
CHV 42x54x120 (1 piece)	2	\$4,967	\$5,215	\$5,463	\$373	\$993	\$869	\$121	\$121	\$242	\$716	\$811	\$474	
ARC BOAT (ARCBOT)														
CHV 42x54x120 (1 piece)	2	\$5,215	\$5,476	\$5,737	\$391	\$1,043	\$913	\$121	\$121	\$242	\$716	\$811	\$474	
OVAL (OVL)														
CHV 42x96	2	\$4,470	\$4,694	\$4,917	\$335	\$894	\$782	\$121	\$121	\$242	\$716	\$811	\$474	
CHV 48x96	2	\$4,584	\$4,813	\$5,042	\$344	\$917	\$802	\$121	\$121	\$242	\$716	\$811	\$474	
CHV 48x120 (1 piece)	2	\$4,827	\$5,068	\$5,309	\$362	\$965	\$845	\$121	\$121	\$242	\$716	\$811	\$474	
CHV 60x120 (1 piece)	2	\$5,356	\$5,624	\$5,892	\$402	\$1,071	\$937	\$121	\$121	\$242	\$716	\$811	\$474	

VOLUMA CONFERENCE TABLES - (LAMINATE - WOOD EDGE)

HALF CYLINDER BASE - VENEER





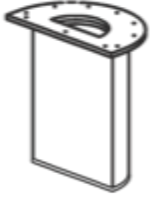

	# of Bases	Edge Choice: Wood (Red Oak & Maple)			Wood Upgrade	OPTIONS					
		 W-12	 W-23	 W-19	Upgrade: Walnut / Mahogany / Cherry	Grommet - Top	Grommet - Bottom	Two Grommets	Accessory Door 10" x 10"	Accessory Door & Grommet Top	SPECIAL HEIGHT
		 W-18	 W-17	ADD		Add Per Base	Add Per Base	Add Per Base	Add Per Base	Add Per Base	ADD
		 W-16	 W-32								
RECTANGLE (REC)											
CHV 36x96	2	\$6,407	\$7,475	\$8,543	15%	\$121	\$121	\$242	\$716	\$811	\$474
CHV 36x120 (1 piece)	2	\$6,692	\$7,807	\$8,922	15%	\$121	\$121	\$242	\$716	\$811	\$474
CHV 42x96	2	\$8,222	\$9,867	\$10,963	15%	\$121	\$121	\$242	\$716	\$811	\$474
CHV 42x120 (1 piece)	2	N/A	N/A	N/A	N/A	\$121	\$121	\$242	\$716	\$811	\$474
CHV 48x96	2	\$8,436	\$10,123	\$11,247	15%	\$121	\$121	\$242	\$716	\$811	\$474
CHV 48x120 (1 piece)	2	\$8,891	\$10,669	\$11,854	15%	\$121	\$121	\$242	\$716	\$811	\$474
CHV 60x96	2	\$9,329	\$11,195	\$12,438	15%	\$121	\$121	\$242	\$716	\$811	\$474
CHV 60x120 (1 piece)	2	\$9,883	\$11,860	\$13,178	15%	\$121	\$121	\$242	\$716	\$811	\$474
ARC RECTANGLE (ARC REC)											
CHV 36x96	2	\$8,410	\$10,091	\$11,213	15%	\$121	\$121	\$242	\$716	\$811	\$474
CHV 36x120 (1 piece)	2	\$8,783	\$10,540	\$11,711	15%	\$121	\$121	\$242	\$716	\$811	\$474
CHV 42x96	2	\$8,633	\$10,360	\$11,511	15%	\$121	\$121	\$242	\$716	\$811	\$474
CHV 42x120 (1 piece)	2	\$9,059	\$10,871	\$12,079	15%	\$121	\$121	\$242	\$716	\$811	\$474
CHV 48x96	2	\$8,857	\$10,629	\$11,810	15%	\$121	\$121	\$242	\$716	\$811	\$474
CHV 48x120 (1 piece)	2	\$9,335	\$11,202	\$12,447	15%	\$121	\$121	\$242	\$716	\$811	\$474
CHV 60x96	2	\$9,795	\$11,754	\$13,060	15%	\$121	\$121	\$242	\$716	\$811	\$474
CHV 60x120 (1 piece)	2	\$10,378	\$12,453	\$13,837	15%	\$121	\$121	\$242	\$716	\$811	\$474
RACETRACK (RAC)											
CHV 42x96	2	\$8,382	\$10,058	\$11,175	15%	\$121	\$121	\$242	\$716	\$811	\$474
CHV 42x120 (1 piece)	2	\$8,787	\$10,544	\$11,716	15%	\$121	\$121	\$242	\$716	\$811	\$474
CHV 48x96	2	\$8,595	\$10,314	\$11,460	15%	\$121	\$121	\$242	\$716	\$811	\$474
CHV 48x120 (1 piece)	2	\$9,050	\$10,860	\$12,066	15%	\$121	\$121	\$242	\$716	\$811	\$474
BOAT (BOT)											
CHV 42x54x120 (1 piece)	2	\$9,313	\$11,175	\$12,417	15%	\$121	\$121	\$242	\$716	\$811	\$474
ARC BOAT (ARCBOT)											
CHV 42x54x120 (1 piece)	2	\$9,778	\$11,734	\$13,038	15%	\$121	\$121	\$242	\$716	\$811	\$474
OVAL (OVL)											
CHV 42x96	2	\$8,382	\$10,058	\$11,175	15%	\$121	\$121	\$242	\$716	\$811	\$474
CHV 48x96	2	\$8,595	\$10,314	\$11,460	15%	\$121	\$121	\$242	\$716	\$811	\$474
CHV 48x120 (1 piece)	2	\$9,050	\$10,860	\$12,066	15%	\$121	\$121	\$242	\$716	\$811	\$474
CHV 60x120 (1 piece)	2	\$10,043	\$12,051	\$13,390	15%	\$121	\$121	\$242	\$716	\$811	\$474

VOLUMA CONFERENCE TABLES - (VENEER)

HALF CYLINDER BASE - VENEER



	# of Bases	Edge Choice: Wood (Red Oak & Maple)			Wood Upgrade	OPTIONS					SPECIAL HEIGHT
					Upgrade: Walnut / Mahogany / Cherry	Grommet - Top	Grommet - Bottom	Two Grommets	Accessory Door 10" x 10"	Accessory Door & Grommet Top	
				ADD		Add Per Base	Add Per Base	Add Per Base	Add Per Base	Add Per Base	
RECTANGLE (REC)											
CHV 36x96	2	\$6,872	\$7,559	\$7,903	15%	\$121	\$121	\$242	\$716	\$811	\$474
CHV 36x120 (1 piece)	2	\$7,991	\$8,790	\$9,190	15%	\$121	\$121	\$242	\$716	\$811	\$474
CHV 42x96	2	\$7,991	\$8,790	\$9,190	15%	\$121	\$121	\$242	\$716	\$811	\$474
CHV 42x120 (1 piece)	2	\$7,991	\$8,790	\$9,190	N/A	\$121	\$121	\$242	\$716	\$811	\$474
CHV 48x96	2	\$7,991	\$8,790	\$9,190	15%	\$121	\$121	\$242	\$716	\$811	\$474
CHV 48x120 (1 piece)	2	\$9,475	\$10,423	\$10,897	15%	\$121	\$121	\$242	\$716	\$811	\$474
CHV 60x96	2	\$9,738	\$10,711	\$11,198	15%	\$121	\$121	\$242	\$716	\$811	\$474
CHV 60x120 (1 piece)	2	\$11,229	\$12,352	\$12,914	15%	\$121	\$121	\$242	\$716	\$811	\$474
ARC RECTANGLE (ARC REC)											
CHV 36x96	2	\$7,216	\$7,937	\$8,298	15%	\$121	\$121	\$242	\$716	\$811	\$474
CHV 36x120 (1 piece)	2	\$8,383	\$9,221	\$9,640	15%	\$121	\$121	\$242	\$716	\$811	\$474
CHV 42x96	2	\$8,390	\$9,229	\$9,649	15%	\$121	\$121	\$242	\$716	\$811	\$474
CHV 42x120 (1 piece)	2	\$9,949	\$10,944	\$11,442	15%	\$121	\$121	\$242	\$716	\$811	\$474
CHV 48x96	2	\$8,390	\$9,229	\$9,649	15%	\$121	\$121	\$242	\$716	\$811	\$474
CHV 48x120 (1 piece)	2	\$9,949	\$10,944	\$11,442	15%	\$121	\$121	\$242	\$716	\$811	\$474
CHV 60x96	2	\$10,224	\$11,247	\$11,758	15%	\$121	\$121	\$242	\$716	\$811	\$474
CHV 60x120 (1 piece)	2	\$11,791	\$12,970	\$13,560	15%	\$121	\$121	\$242	\$716	\$811	\$474
RACETRACK (RAC)											
CHV 42x96	2	\$8,493	\$9,343	\$9,767	15%	\$121	\$121	\$242	\$716	\$811	\$474
CHV 42x120 (1 piece)	2	\$8,904	\$9,794	\$10,240	15%	\$121	\$121	\$242	\$716	\$811	\$474
CHV 48x96	2	\$8,525	\$9,377	\$9,803	15%	\$121	\$121	\$242	\$716	\$811	\$474
CHV 48x120 (1 piece)	2	\$10,009	\$11,010	\$11,511	15%	\$121	\$121	\$242	\$716	\$811	\$474
BOAT (BOT)											
CHV 42x54x120 (1 piece)	2	\$9,437	\$10,381	\$10,852	15%	\$121	\$121	\$242	\$716	\$811	\$474
ARC BOAT (ARCBOT)											
CHV 42x54x120 (1 piece)	2	\$9,909	\$10,900	\$11,395	15%	\$121	\$121	\$242	\$716	\$811	\$474
OVAL (OVL)											
CHV 42x96	2	\$9,154	\$10,069	\$10,527	15%	\$121	\$121	\$242	\$716	\$811	\$474
CHV 48x96	2	\$9,154	\$10,069	\$10,527	15%	\$121	\$121	\$242	\$716	\$811	\$474
CHV 48x120 (1 piece)	2	\$10,923	\$12,016	\$12,562	15%	\$121	\$121	\$242	\$716	\$811	\$474
CHV 60x120 (1 piece)	2	\$13,043	\$14,347	\$14,999	15%	\$121	\$121	\$242	\$716	\$811	\$474

VOLUMA CONFERENCE TABLES - (LAMINATE - PVC & WOOD EDG

FLAT PANEL BASE - LAMINATE

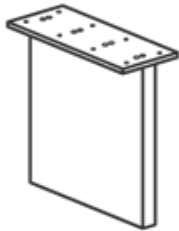

		Edge Choice: PVC & T-Mold				Edge Choice: Wood (Red Oak & Maple)				Wood Upgrade	Laminate Upgrades		Options		Light Weight
		T-15	L-21	P-14	PK-2	W-12	W-23	W-19	Upgrade: Walnut / Mahogany/Cherr	Laminate Upgrade I	Laminate Upgrade II	SPECIAL HEIGHT	WIRE PATH	Light Weight (PVC only - 1" top)	
		P-10 (self)	P-12		PK-4	W-18	W-17	ADD		ADD	ADD	ADD	ADD		
		L-15			L-23	W-16	W-32								
RECTANGLE (REC)															
CP	42x96	\$2,843	\$2,985	\$3,128	\$5,331	\$6,397	\$7,108	15%	\$213	\$569	\$474	\$390	\$498		
CP	48x96	\$2,957	\$3,105	\$3,253	\$5,544	\$6,653	\$7,392	15%	\$222	\$591	\$474	\$390	\$517		
CP	48x120 (1 piece)	\$4,099	\$4,303	\$4,508	\$7,685	\$9,222	\$10,246	15%	\$307	\$820	\$474	\$390	\$717		
CP	48x144 (1 piece)	\$4,341	\$4,558	\$4,775	\$8,140	\$9,768	\$10,853	15%	\$326	\$868	\$474	\$390	\$760		
CP	48x168 (2 pieces)	\$5,483	\$5,757	\$6,031	\$10,280	\$12,336	\$13,707	15%	\$411	\$1,097	\$474	\$390	\$959		
CP	48x192 (2 pieces)	\$5,725	\$6,012	\$6,298	\$10,735	\$12,882	\$14,314	15%	\$429	\$1,145	\$474	\$390	\$1,002		
CP	60x120 (1 piece)	\$4,379	\$4,598	\$4,817	\$8,211	\$9,853	\$10,947	15%	\$328	\$876	\$474	\$390	\$766		
CP	60x144 (1 piece)	\$4,675	\$4,908	\$5,142	\$8,765	\$10,518	\$11,687	15%	\$351	\$935	\$474	\$390	\$818		
CP	60x168 (2 pieces)	\$5,869	\$6,163	\$6,456	\$11,005	\$13,206	\$14,673	15%	\$440	\$1,174	\$474	\$390	\$1,027		
CP	60x192 (2 pieces)	\$6,165	\$6,473	\$6,782	\$11,559	\$13,871	\$15,413	15%	\$462	\$1,233	\$474	\$390	\$1,079		
CP	60x240 (2 pieces)	\$6,757	\$7,094	\$7,432	\$12,668	\$15,202	\$16,891	15%	\$507	\$1,351	\$474	\$390	\$1,182		
ARC RECTANGLE (ARCREC)															
CP	42x96	\$2,985	\$3,135	\$3,284	\$5,598	\$6,717	\$7,464	15%	\$224	\$597	\$474	\$390	\$522		
CP	48x96	\$3,105	\$3,260	\$3,415	\$5,822	\$6,986	\$7,762	15%	\$233	\$621	\$474	\$390	\$543		
CP	48x120 (1 piece)	\$4,303	\$4,519	\$4,734	\$8,069	\$9,683	\$10,759	15%	\$323	\$861	\$474	\$390	\$753		
CP	48x144 (1 piece)	\$4,558	\$4,786	\$5,014	\$8,547	\$10,256	\$11,396	15%	\$342	\$912	\$474	\$390	\$798		
CP	48x168 (2 pieces)	\$5,757	\$6,045	\$6,333	\$10,794	\$12,953	\$14,392	15%	\$432	\$1,151	\$474	\$390	\$1,007		
CP	48x192 (2 pieces)	\$6,012	\$6,312	\$6,613	\$11,272	\$13,526	\$15,029	15%	\$451	\$1,202	\$474	\$390	\$1,052		
CP	60x120 (1 piece)	\$4,598	\$4,828	\$5,058	\$8,621	\$10,345	\$11,495	15%	\$345	\$920	\$474	\$390	\$805		
CP	60x144 (1 piece)	\$4,908	\$5,154	\$5,399	\$9,203	\$11,044	\$12,271	15%	\$368	\$982	\$474	\$390	\$859		
CP	60x168 (2 pieces)	\$6,163	\$6,471	\$6,779	\$11,555	\$13,866	\$15,407	15%	\$462	\$1,233	\$474	\$390	\$1,078		
CP	60x192 (2 pieces)	\$6,473	\$6,797	\$7,121	\$12,137	\$14,565	\$16,183	15%	\$485	\$1,295	\$474	\$390	\$1,133		
CP	60x240 (2 pieces)	\$7,094	\$7,449	\$7,804	\$13,302	\$15,962	\$17,736	15%	\$532	\$1,419	\$474	\$390	\$1,242		
RACETRACK (RAC)															
CP	42x84	\$2,820	\$2,961	\$3,102	\$5,288	\$6,345	\$7,050	15%	\$212	\$564	\$474	\$390	\$494		
CP	42x96	\$2,928	\$3,075	\$3,221	\$5,490	\$6,588	\$7,320	15%	\$220	\$586	\$474	\$390	\$512		
CP	48x96	\$3,042	\$3,194	\$3,346	\$5,704	\$6,844	\$7,605	15%	\$228	\$608	\$474	\$390	\$532		
CP	48x120 (1 piece)	\$4,183	\$4,393	\$4,602	\$7,844	\$9,413	\$10,459	15%	\$314	\$837	\$474	\$390	\$732		
CP	48x144 (1 piece)	\$4,426	\$4,647	\$4,869	\$8,299	\$9,959	\$11,065	15%	\$332	\$885	\$474	\$390	\$775		
CP	60x144 (1 piece)	\$4,760	\$4,998	\$5,236	\$8,924	\$10,709	\$11,899	15%	\$357	\$952	\$474	\$390	\$833		
CP	60x192 (2 pieces)	\$6,250	\$6,562	\$6,875	\$11,719	\$14,062	\$15,625	15%	\$469	\$1,250	\$474	\$390	\$1,094		
CP	60x240 (2 pieces)	\$6,841	\$7,184	\$7,526	\$12,828	\$15,393	\$17,104	15%	\$513	\$1,368	\$474	\$390	\$1,197		
BOAT (BOT)															
CP	36x48x96	\$3,042	\$3,194	\$3,346	\$5,704	\$6,844	\$7,605	15%	\$228	\$608	\$474	\$390	\$532		
CP	42x54x120 (1 piece)	\$4,324	\$4,540	\$4,756	\$8,107	\$9,728	\$10,809	15%	\$324	\$865	\$474	\$390	\$757		

VOLUMA CONFERENCE TABLES - (LAMINATE - PVC & WOOD EDG

FLAT PANEL BASE - LAMINATE

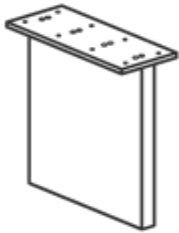

		Edge Choice: PVC & T-Mold				Edge Choice: Wood (Red Oak & Maple)			Wood Upgrade	Laminate Upgrades		Options		Light Weight
		T-15	L-21	P-14	PK-2	W-12	W-23	W-19	Upgrade: Walnut / Mahogany/Cherr	Laminate Upgrade I	Laminate Upgrade II	SPECIAL HEIGHT	WIRE PATH	Light Weight (PVC only - 1" top)
		P-10 (self)	P-12		PK-4		W-18	W-17		ADD	ADD	ADD	ADD	
		L-15			L-23		W-16	W-32						
CP	42x54x144 (1 piece)	\$4,593		\$4,823	\$5,052	\$8,612	\$10,334	\$11,482	15%	\$344	\$919	\$474	\$390	\$804
CP	48x60x192 (2 pieces)	\$6,250		\$6,562	\$6,875	\$11,719	\$14,062	\$15,625	15%	\$469	\$1,250	\$474	\$390	\$1,094
CP	48x60x240 (2 pieces)	\$6,841		\$7,184	\$7,526	\$12,828	\$15,393	\$17,104	15%	\$513	\$1,368	\$474	\$390	\$1,197
ARC BOAT (ARCBOT)														
CP	36x48x96	\$3,194		\$3,354	\$3,513	\$5,989	\$7,186	\$7,985	15%	\$240	\$639	\$474	\$390	\$559
CP	42x54x120 (1 piece)	\$4,540		\$4,767	\$4,994	\$8,512	\$10,215	\$11,350	15%	\$340	\$908	\$474	\$390	\$794
CP	42x54x144 (1 piece)	\$4,823		\$5,064	\$5,305	\$9,042	\$10,851	\$12,056	15%	\$362	\$965	\$474	\$390	\$844
CP	48x60x192 (2 pieces)	\$6,562		\$6,891	\$7,219	\$12,305	\$14,765	\$16,406	15%	\$492	\$1,312	\$474	\$390	\$1,148
CP	48x60x240 (2 pieces)	\$7,184		\$7,543	\$7,902	\$13,469	\$16,163	\$17,959	15%	\$539	\$1,437	\$474	\$390	\$1,257
OVAL (OVL)														
CP	42x96	\$2,928		\$3,075	\$3,221	\$5,490	\$6,588	\$7,320	15%	\$220	\$586	\$474	\$390	\$512
CP	48x96	\$3,042		\$3,194	\$3,346	\$5,704	\$6,844	\$7,605	15%	\$228	\$608	\$474	\$390	\$532
CP	48x120 (1 piece)	\$3,285		\$3,449	\$3,613	\$6,159	\$7,390	\$8,212	15%	\$246	\$657	\$474	\$390	\$575
CP	48x144 (1 piece)	\$4,426		\$4,647	\$4,869	\$8,299	\$9,959	\$11,065	15%	\$332	\$885	\$474	\$390	\$775
CP	60x120 (1 piece)	\$3,565		\$3,743	\$3,922	\$6,684	\$8,021	\$8,913	15%	\$267	\$713	\$474	\$390	\$624
CP	60x144 (1 piece)	\$4,760		\$4,998	\$5,236	\$8,924	\$10,709	\$11,899	15%	\$357	\$952	\$474	\$390	\$833

VOLUMA CONFERENCE TABLES - (VENEER)

FLAT PANEL BASE - LAMINATE

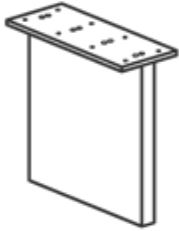

		Edge Choice: Wood (Red Oak & Maple)			Wood Upgrade	Options	
		V-12	V-23	V-19	Upgrade: Walnut / Mahogany / Cherry	SPECIAL HEIGHT	WIRE PATH
			V-18	V-17			
			V-16	V-32			
RECTANGLE (REC)							
CP	42x96	\$5,971	\$6,568	\$6,866	15%	\$474	\$390
CP	48x96	\$6,210	\$6,831	\$7,141	15%	\$474	\$390
CP	48x120 (1 piece)	\$8,798	\$9,678	\$10,118	15%	\$474	\$390
CP	48x144 (1 piece)	\$9,990	\$10,990	\$11,489	15%	\$474	\$390
CP	48x168 (2 pieces)	\$12,129	\$13,341	\$13,948	15%	\$474	\$390
CP	48x192 (2 pieces)	\$13,321	\$14,653	\$15,319	15%	\$474	\$390
CP	60x120 (1 piece)	\$10,290	\$11,319	\$11,834	15%	\$474	\$390
CP	60x144 (1 piece)	\$11,782	\$12,960	\$13,549	15%	\$474	\$390
CP	60x168 (2 pieces)	\$14,213	\$15,634	\$16,345	15%	\$474	\$390
CP	60x192 (2 pieces)	\$15,705	\$17,275	\$18,060	15%	\$474	\$390
CP	60x240 (2 pieces)	\$18,688	\$20,557	\$21,492	15%	\$474	\$390
ARC RECTANGLE (ARC REC)							
CP	42x96	\$6,269	\$6,896	\$7,210	15%	\$474	\$390
CP	48x96	\$6,520	\$7,172	\$7,498	15%	\$474	\$390
CP	48x120 (1 piece)	\$9,238	\$10,162	\$10,624	15%	\$474	\$390
CP	48x144 (1 piece)	\$10,490	\$11,539	\$12,063	15%	\$474	\$390
CP	48x168 (2 pieces)	\$12,735	\$14,009	\$14,645	15%	\$474	\$390
CP	48x192 (2 pieces)	\$13,987	\$15,385	\$16,085	15%	\$474	\$390
CP	60x120 (1 piece)	\$10,805	\$11,885	\$12,426	15%	\$474	\$390
CP	60x144 (1 piece)	\$12,371	\$13,608	\$14,227	15%	\$474	\$390
CP	60x168 (2 pieces)	\$14,923	\$16,416	\$17,162	15%	\$474	\$390
CP	60x192 (2 pieces)	\$16,490	\$18,139	\$18,963	15%	\$474	\$390
CP	60x240 (2 pieces)	\$19,623	\$21,585	\$22,566	15%	\$474	\$390
RACETRACK (RAC)							
CP	42x84	\$5,922	\$6,514	\$6,810	15%	\$474	\$390
CP	42x96	\$6,149	\$6,764	\$7,072	15%	\$474	\$390
CP	48x96	\$6,902	\$7,592	\$7,937	15%	\$474	\$390
CP	48x120 (1 piece)	\$9,332	\$10,266	\$10,732	15%	\$474	\$390
CP	48x144 (1 piece)	\$10,524	\$11,577	\$12,103	15%	\$474	\$390
CP	60x144 (1 piece)	\$12,316	\$13,548	\$14,163	15%	\$474	\$390
CP	60x192 (2 pieces)	\$16,238	\$17,862	\$18,674	15%	\$474	\$390
CP	60x240 (2 pieces)	\$19,222	\$21,144	\$22,106	15%	\$474	\$390
BOAT (BOT)							
CP	36x48x96	\$6,388	\$7,027	\$7,346	15%	\$474	\$390
CP	42x54x120 (1 piece)	\$9,080	\$9,988	\$10,442	15%	\$474	\$390

VOLUMA CONFERENCE TABLES - (VENEER)

FLAT PANEL BASE - LAMINATE

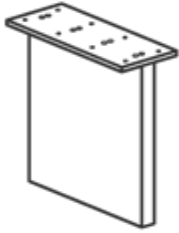

		Edge Choice: Wood (Red Oak & Maple)			Wood Upgrade	Options	
		V-12	V-23	V-19	Upgrade: Walnut / Mahogany / Cherry	SPECIAL HEIGHT	WIRE PATH
			V-18	V-17		ADD	ADD
			V-16	V-32			
CP	42x54x144 (1 piece)	\$9,645	\$10,610	\$11,092	15%	\$474	\$390
CP	48x60x192 (2 pieces)	\$13,125	\$14,437	\$15,094	15%	\$474	\$390
CP	48x60x240 (2 pieces)	\$14,367	\$15,804	\$16,522	15%	\$474	\$390
ARC BOAT (ARCBOT)							
CP	36x48x96	\$6,707	\$7,378	\$7,713	15%	\$474	\$390
CP	42x54x120 (1 piece)	\$9,534	\$10,487	\$10,964	15%	\$474	\$390
CP	42x54x144 (1 piece)	\$10,127	\$11,140	\$11,646	15%	\$474	\$390
CP	48x60x192 (2 pieces)	\$13,781	\$15,159	\$15,848	15%	\$474	\$390
CP	48x60x240 (2 pieces)	\$15,085	\$16,594	\$17,348	15%	\$474	\$390
OVAL (OVL)							
CP	42x96	\$7,531	\$8,284	\$8,660	15%	\$474	\$390
CP	48x96	\$7,531	\$8,284	\$8,660	15%	\$474	\$390
CP	48x120 (1 piece)	\$9,300	\$10,230	\$10,695	15%	\$474	\$390
CP	48x144 (1 piece)	\$11,731	\$12,904	\$13,491	15%	\$474	\$390
CP	60x120 (1 piece)	\$11,158	\$12,274	\$12,831	15%	\$474	\$390
CP	60x144 (1 piece)	\$13,954	\$15,350	\$16,047	15%	\$474	\$390

VOLUMA CONFERENCE TABLES - (LAMINATE - PVC & WOOD ED

OVAL BASE - LAMINATE

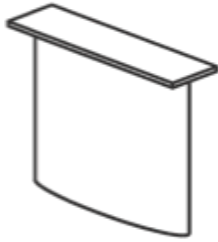

		Edge Choice: PVC & T-Mold				Edge Choice: Wood (Red Oak & Maple)			Wood Upgrade	Laminate Upgrades		Option	Light Weight
		T-15 	L-21 	P-14 	PK-2 	W-12 	W-23 	W-19 	Upgrade: Walnut / Mahogany / Cherry	Laminate Upgrade I	Laminate Upgrade II	SPECIAL HEIGHT	Light Weight (PVC only - 1" top)
		P-10 (self) 	P-12 		PK-4 		W-18 	W-17 		ADD	ADD	ADD	
		L-15 			L-23 		W-16 	W-32 					
RECTANGLE (REC)													
CO	42x96	\$3,482	\$3,657	\$3,831	\$6,530	\$7,835	\$8,706	15%	\$261	\$696	\$474	\$609	
CO	48x96	\$3,596	\$3,776	\$3,956	\$6,743	\$8,091	\$8,990	15%	\$270	\$719	\$474	\$629	
CO	48x120 (1 piece)	\$5,057	\$5,310	\$5,563	\$9,482	\$11,379	\$12,643	15%	\$379	\$1,011	\$474	\$885	
CO	48x144 (1 piece)	\$5,300	\$5,565	\$5,830	\$9,937	\$11,925	\$13,250	15%	\$397	\$1,060	\$474	\$927	
CO	48x168 (2 pieces)	\$6,761	\$7,099	\$7,437	\$12,677	\$15,212	\$16,903	15%	\$507	\$1,352	\$474	\$1,183	
CO	48x192 (2 pieces)	\$7,004	\$7,354	\$7,704	\$13,132	\$15,758	\$17,509	15%	\$525	\$1,401	\$474	\$1,226	
CO	60x120 (1 piece)	\$5,338	\$5,605	\$5,871	\$10,008	\$12,010	\$13,344	15%	\$400	\$1,068	\$474	\$934	
CO	60x144 (1 piece)	\$5,633	\$5,915	\$6,197	\$10,563	\$12,675	\$14,084	15%	\$423	\$1,127	\$474	\$986	
CO	60x168 (2 pieces)	\$7,148	\$7,505	\$7,862	\$13,402	\$16,082	\$17,869	15%	\$536	\$1,430	\$474	\$1,251	
CO	60x192 (2 pieces)	\$7,443	\$7,816	\$8,188	\$13,956	\$16,748	\$18,608	15%	\$558	\$1,489	\$474	\$1,303	
CO	60x240 (2 pieces)	\$8,035	\$8,437	\$8,838	\$15,065	\$18,078	\$20,087	15%	\$603	\$1,607	\$474	\$1,406	
ARC RECTANGLE (ARCREC)													
CO	42x96	\$3,657	\$3,839	\$4,022	\$6,856	\$8,227	\$9,141	15%	\$274	\$731	\$474	\$640	
CO	48x96	\$3,776	\$3,965	\$4,154	\$7,080	\$8,496	\$9,440	15%	\$283	\$755	\$474	\$661	
CO	48x120 (1 piece)	\$5,310	\$5,576	\$5,841	\$9,956	\$11,948	\$13,275	15%	\$398	\$1,062	\$474	\$929	
CO	48x144 (1 piece)	\$5,565	\$5,843	\$6,121	\$10,434	\$12,521	\$13,912	15%	\$417	\$1,113	\$474	\$974	
CO	48x168 (2 pieces)	\$7,099	\$7,454	\$7,809	\$13,311	\$15,973	\$17,748	15%	\$532	\$1,420	\$474	\$1,242	
CO	48x192 (2 pieces)	\$7,354	\$7,722	\$8,089	\$13,789	\$16,546	\$18,385	15%	\$552	\$1,471	\$474	\$1,287	
CO	60x120 (1 piece)	\$5,605	\$5,885	\$6,165	\$10,509	\$12,610	\$14,011	15%	\$420	\$1,121	\$474	\$981	
CO	60x144 (1 piece)	\$5,915	\$6,211	\$6,507	\$11,091	\$13,309	\$14,788	15%	\$444	\$1,183	\$474	\$1,035	
CO	60x168 (2 pieces)	\$7,505	\$7,880	\$8,255	\$14,072	\$16,886	\$18,762	15%	\$563	\$1,501	\$474	\$1,313	
CO	60x192 (2 pieces)	\$7,816	\$8,206	\$8,597	\$14,654	\$17,585	\$19,539	15%	\$586	\$1,563	\$474	\$1,368	
CO	60x240 (2 pieces)	\$8,437	\$8,858	\$9,280	\$15,819	\$18,982	\$21,091	15%	\$633	\$1,687	\$474	\$1,476	

VOLUMA CONFERENCE TABLES - (LAMINATE - PVC & WOOD ED

OVAL BASE - LAMINATE

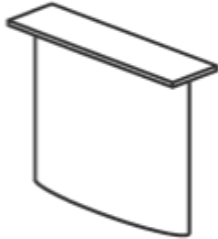





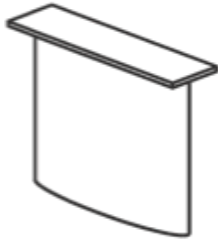

		Edge Choice: PVC & T-Mold				Edge Choice: Wood (Red Oak & Maple)			Wood Upgrade	Laminate Upgrades		Option	Light Weight
		T-15	L-21	P-14	PK-2	W-12	W-23	W-19	Upgrade: Walnut / Mahogany / Cherry	Laminate Upgrade I	Laminate Upgrade II	SPECIAL HEIGHT	Light Weight (PVC only - 1" top)
		P-10 (self)	P-12		PK-4	W-18	W-17	ADD		ADD	ADD	ADD	
		L-15			L-23	W-16	W-32						
RACETRACK (RAC)													
CO	42x84	\$3,459	\$3,632	\$3,805	\$6,486	\$7,783	\$8,648	15%	\$259	\$692	\$474	\$605	
CO	42x96	\$3,567	\$3,746	\$3,924	\$6,689	\$8,026	\$8,918	15%	\$268	\$713	\$474	\$624	
CO	48x96	\$3,681	\$3,865	\$4,049	\$6,902	\$8,282	\$9,203	15%	\$276	\$736	\$474	\$644	
CO	48x120 (1 piece)	\$5,142	\$5,399	\$5,656	\$9,642	\$11,570	\$12,855	15%	\$386	\$1,028	\$474	\$900	
CO	48x144 (1 piece)	\$5,385	\$5,654	\$5,923	\$10,097	\$12,116	\$13,462	15%	\$404	\$1,077	\$474	\$942	
CO	60x144 (1 piece)	\$5,718	\$6,004	\$6,290	\$10,722	\$12,866	\$14,296	15%	\$429	\$1,144	\$474	\$1,001	
CO	60x192 (2 pieces)	\$7,528	\$7,905	\$8,281	\$14,115	\$16,939	\$18,821	15%	\$565	\$1,506	\$474	\$1,317	
CO	60x240 (2 pieces)	\$8,120	\$8,526	\$8,932	\$15,225	\$18,269	\$20,299	15%	\$609	\$1,624	\$474	\$1,421	
BOAT (BOT)													
CO	36x48x96	\$3,681	\$3,865	\$4,049	\$6,902	\$8,282	\$9,203	15%	\$276	\$736	\$474	\$644	
CO	42x54x120 (1 piece)	\$5,282	\$5,546	\$5,811	\$9,904	\$11,885	\$13,206	15%	\$396	\$1,056	\$474	\$924	
CO	42x54x144 (1 piece)	\$5,552	\$5,829	\$6,107	\$10,409	\$12,491	\$13,879	15%	\$416	\$1,110	\$474	\$972	
CO	48x60x192 (2 pieces)	\$7,528	\$7,905	\$8,281	\$14,115	\$16,939	\$18,821	15%	\$565	\$1,506	\$474	\$1,317	
CO	48x60x240 (2 pieces)	\$8,120	\$8,526	\$8,932	\$15,225	\$18,269	\$20,299	15%	\$609	\$1,624	\$474	\$1,421	
ARC BOAT (ARCBOT)													
CO	36x48x96	\$3,865	\$4,058	\$4,252	\$7,247	\$8,696	\$9,663	15%	\$290	\$773	\$474	\$676	
CO	42x54x120 (1 piece)	\$5,546	\$5,824	\$6,101	\$10,400	\$12,480	\$13,866	15%	\$416	\$1,109	\$474	\$971	
CO	42x54x144 (1 piece)	\$5,829	\$6,121	\$6,412	\$10,930	\$13,116	\$14,573	15%	\$437	\$1,166	\$474	\$1,020	
CO	48x60x192 (2 pieces)	\$7,905	\$8,300	\$8,695	\$14,821	\$17,785	\$19,762	15%	\$593	\$1,581	\$474	\$1,383	
CO	48x60x240 (2 pieces)	\$8,526	\$8,952	\$9,378	\$15,986	\$19,183	\$21,314	15%	\$639	\$1,705	\$474	\$1,492	
OVAL (OVL)													
CO	42x96	\$3,567	\$3,746	\$3,924	\$6,689	\$8,026	\$8,918	15%	\$268	\$713	\$474	\$624	
CO	48x96	\$3,681	\$3,865	\$4,049	\$6,902	\$8,282	\$9,203	15%	\$276	\$736	\$474	\$644	
CO	48x120 (1 piece)	\$3,924	\$4,120	\$4,316	\$7,357	\$8,828	\$9,809	15%	\$294	\$785	\$474	\$687	
CO	48x144 (1 piece)	\$5,385	\$5,654	\$5,923	\$10,097	\$12,116	\$13,462	15%	\$404	\$1,077	\$474	\$942	
CO	60x120 (1 piece)	\$4,204	\$4,414	\$4,625	\$7,883	\$9,459	\$10,511	15%	\$315	\$841	\$474	\$736	
CO	60x144 (1 piece)	\$5,718	\$6,004	\$6,290	\$10,722	\$12,866	\$14,296	15%	\$429	\$1,144	\$474	\$1,001	

VOLUMA CONFERENCE TABLES - (VENE

OVAL BASE - LAMINATE







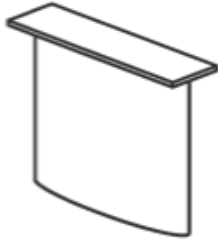

	Edge Choice: Wood (Red Oak & Maple)			Wood Upgrade	Option
	 V-12	 V-23  V-18	 V-19  V-17  V-16  V-32	Upgrade: Walnut / Mahogany / Cherry	SPECIAL HEIGHT
				ADD	ADD
RECTANGLE (REC)					
CO 42x96	\$6,094	\$6,704	\$7,008	15%	\$474
CO 48x96	\$6,293	\$6,923	\$7,237	15%	\$474
CO 48x120 (1 piece)	\$9,808	\$10,788	\$11,279	15%	\$474
CO 48x144 (1 piece)	\$11,000	\$12,100	\$12,650	15%	\$474
CO 48x168 (2 pieces)	\$13,474	\$14,822	\$15,495	15%	\$474
CO 48x192 (2 pieces)	\$14,666	\$16,133	\$16,866	15%	\$474
CO 60x120 (1 piece)	\$11,299	\$12,429	\$12,994	15%	\$474
CO 60x144 (1 piece)	\$12,791	\$14,070	\$14,710	15%	\$474
CO 60x168 (2 pieces)	\$15,558	\$17,114	\$17,892	15%	\$474
CO 60x192 (2 pieces)	\$17,050	\$18,755	\$19,608	15%	\$474
CO 60x240 (2 pieces)	\$20,034	\$22,037	\$23,039	15%	\$474
ARC RECTANGLE (ARC REC)					
CO 42x96	\$6,399	\$7,039	\$7,359	15%	\$474
CO 48x96	\$6,608	\$7,269	\$7,599	15%	\$474
CO 48x120 (1 piece)	\$10,298	\$11,328	\$11,843	15%	\$474
CO 48x144 (1 piece)	\$11,550	\$12,705	\$13,282	15%	\$474
CO 48x168 (2 pieces)	\$14,148	\$15,563	\$16,270	15%	\$474
CO 48x192 (2 pieces)	\$15,400	\$16,939	\$17,709	15%	\$474
CO 60x120 (1 piece)	\$11,864	\$13,051	\$13,644	15%	\$474
CO 60x144 (1 piece)	\$13,431	\$14,774	\$15,446	15%	\$474
CO 60x168 (2 pieces)	\$16,336	\$17,970	\$18,787	15%	\$474
CO 60x192 (2 pieces)	\$17,903	\$19,693	\$20,588	15%	\$474
CO 60x240 (2 pieces)	\$21,036	\$23,139	\$24,191	15%	\$474

VOLUMA CONFERENCE TABLES - (VENE)

OVAL BASE - LAMINATE



	Edge Choice: Wood (Red Oak & Maple)			Wood Upgrade	Option	
	 V-12	 V-23	 V-19	Upgrade: Walnut / Mahogany / Cherry	SPECIAL HEIGHT	
	 V-18	 V-17	ADD			ADD
	 V-16	 V-32				
RACETRACK (RAC)						
CO 42x84	\$6,054	\$6,659	\$6,962	15%	\$474	
CO 42x96	\$6,243	\$6,867	\$7,179	15%	\$474	
CO 48x96	\$7,574	\$8,332	\$8,711	15%	\$474	
CO 48x120 (1 piece)	\$10,341	\$11,376	\$11,893	15%	\$474	
CO 48x144 (1 piece)	\$11,534	\$12,687	\$13,264	15%	\$474	
CO 60x144 (1 piece)	\$13,325	\$14,658	\$15,324	15%	\$474	
CO 60x192 (2 pieces)	\$17,584	\$19,342	\$20,222	15%	\$474	
CO 60x240 (2 pieces)	\$20,568	\$22,625	\$23,653	15%	\$474	
BOAT (BOT)						
CO 36x48x96	\$6,442	\$7,086	\$7,408	15%	\$474	
CO 42x54x120 (1 piece)	\$9,244	\$10,169	\$10,631	15%	\$474	
CO 42x54x144 (1 piece)	\$9,715	\$10,687	\$11,173	15%	\$474	
CO 48x60x192 (2 pieces)	\$13,174	\$14,492	\$15,151	15%	\$474	
CO 48x60x240 (2 pieces)	\$14,210	\$15,631	\$16,341	15%	\$474	
ARC BOAT (ARCBOT)						
CO 36x48x96	\$6,764	\$7,440	\$7,779	15%	\$474	
CO 42x54x120 (1 piece)	\$9,706	\$10,677	\$11,162	15%	\$474	
CO 42x54x144 (1 piece)	\$10,201	\$11,221	\$11,731	15%	\$474	
CO 48x60x192 (2 pieces)	\$13,833	\$15,216	\$15,908	15%	\$474	
CO 48x60x240 (2 pieces)	\$14,920	\$16,412	\$17,158	15%	\$474	
OVAL (OVL)						
CO 42x96	\$8,203	\$9,024	\$9,434	15%	\$474	
CO 48x96	\$8,203	\$9,024	\$9,434	15%	\$474	
CO 48x120 (1 piece)	\$9,973	\$10,970	\$11,469	15%	\$474	
CO 48x144 (1 piece)	\$12,740	\$14,014	\$14,651	15%	\$474	
CO 60x120 (1 piece)	\$11,831	\$13,014	\$13,605	15%	\$474	
CO 60x144 (1 piece)	\$14,963	\$16,460	\$17,208	15%	\$474	

VOLUMA CONFERENCE TABLES - (LAMINATE - PVC & WOOD ED

OVAL BASE - VENEER

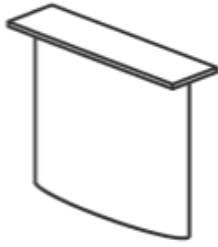

	Edge Choice: PVC & T-Mold				Edge Choice: Wood (Red Oak & Maple)			Wood Upgrade	Laminate Upgrades		Option	Light Weight
	T-15 P-10 (self) L-15	L-21 P-12	P-14	PK-2 PK-4 L-23	W-12	W-23 W-18 W-16	W-19 W-17 W-32	Upgrade: Walnut / Mahogany / Cherry	Laminate Upgrade I	Laminate Upgrade II	SPECIAL HEIGHT	Light Weight (PVC only - 1" top)
								ADD	ADD	ADD	ADD	ADD
RECTANGLE (REC)												
COV 42x96	\$6,199		\$6,509	\$6,819	\$11,623	\$13,947	\$15,497	15%	\$465	\$1,240	\$474	\$1,085
COV 48x96	\$6,313		\$6,628	\$6,944	\$11,836	\$14,203	\$15,781	15%	\$473	\$1,263	\$474	\$1,105
COV 48x120 (1 piece)	\$9,132		\$9,588	\$10,045	\$17,122	\$20,547	\$22,830	15%	\$685	\$1,826	\$474	\$1,598
COV 48x144 (1 piece)	\$9,375		\$9,843	\$10,312	\$17,577	\$21,093	\$23,436	15%	\$703	\$1,875	\$474	\$1,641
COV 48x168 (2 pieces)	\$12,194		\$12,804	\$13,413	\$22,864	\$27,436	\$30,485	15%	\$915	\$2,439	\$474	\$2,134
COV 48x192 (2 pieces)	\$12,437		\$13,058	\$13,680	\$23,319	\$27,982	\$31,091	15%	\$933	\$2,487	\$474	\$2,176
COV 60x120 (1 piece)	\$9,412		\$9,883	\$10,354	\$17,648	\$21,178	\$23,531	15%	\$706	\$1,882	\$474	\$1,647
COV 60x144 (1 piece)	\$9,708		\$10,193	\$10,679	\$18,203	\$21,843	\$24,270	15%	\$728	\$1,942	\$474	\$1,699
COV 60x168 (2 pieces)	\$12,580		\$13,209	\$13,838	\$23,588	\$28,306	\$31,451	15%	\$944	\$2,516	\$474	\$2,202
COV 60x192 (2 pieces)	\$12,876		\$13,520	\$14,164	\$24,143	\$28,971	\$32,190	15%	\$966	\$2,575	\$474	\$2,253
COV 60x240 (2 pieces)	\$13,468		\$14,141	\$14,814	\$25,252	\$30,302	\$33,669	15%	\$1,010	\$2,694	\$474	\$2,357
ARC RECTANGLE (ARCREC)												
COV 42x96	\$6,509		\$6,834	\$7,160	\$12,204	\$14,645	\$16,272	15%	\$488	\$1,302	\$474	\$1,139
COV 48x96	\$6,628		\$6,960	\$7,291	\$12,428	\$14,913	\$16,570	15%	\$497	\$1,326	\$474	\$1,160
COV 48x120 (1 piece)	\$9,588		\$10,068	\$10,547	\$17,978	\$21,574	\$23,971	15%	\$719	\$1,918	\$474	\$1,678
COV 48x144 (1 piece)	\$9,843		\$10,335	\$10,828	\$18,456	\$22,147	\$24,608	15%	\$738	\$1,969	\$474	\$1,723
COV 48x168 (2 pieces)	\$12,804		\$13,444	\$14,084	\$24,007	\$28,808	\$32,009	15%	\$960	\$2,561	\$474	\$2,241
COV 48x192 (2 pieces)	\$13,058		\$13,711	\$14,364	\$24,485	\$29,381	\$32,646	15%	\$979	\$2,612	\$474	\$2,285
COV 60x120 (1 piece)	\$9,883		\$10,377	\$10,871	\$18,530	\$22,237	\$24,707	15%	\$741	\$1,977	\$474	\$1,730
COV 60x144 (1 piece)	\$10,193		\$10,703	\$11,213	\$19,113	\$22,935	\$25,484	15%	\$765	\$2,039	\$474	\$1,784
COV 60x168 (2 pieces)	\$13,209		\$13,870	\$14,530	\$24,768	\$29,721	\$33,024	15%	\$991	\$2,642	\$474	\$2,312
COV 60x192 (2 pieces)	\$13,520		\$14,196	\$14,872	\$25,350	\$30,420	\$33,800	15%	\$1,014	\$2,704	\$474	\$2,366
COV 60x240 (2 pieces)	\$14,141		\$14,848	\$15,555	\$26,514	\$31,817	\$35,353	15%	\$1,061	\$2,828	\$474	\$2,475
RACETRACK (RAC)												
COV 42x84	\$6,176		\$6,484	\$6,793	\$11,579	\$13,895	\$15,439	15%	\$463	\$1,235	\$474	\$1,081
COV 42x96	\$6,284		\$6,598	\$6,912	\$11,782	\$14,138	\$15,709	15%	\$471	\$1,257	\$474	\$1,100
COV 48x96	\$6,397		\$6,717	\$7,037	\$11,995	\$14,394	\$15,994	15%	\$480	\$1,279	\$474	\$1,120
COV 48x120 (1 piece)	\$9,217		\$9,678	\$10,138	\$17,281	\$20,738	\$23,042	15%	\$691	\$1,843	\$474	\$1,613
COV 48x144 (1 piece)	\$9,459		\$9,932	\$10,405	\$17,737	\$21,284	\$23,649	15%	\$709	\$1,892	\$474	\$1,655
COV 60x144 (1 piece)	\$9,793		\$10,283	\$10,772	\$18,362	\$22,034	\$24,482	15%	\$734	\$1,959	\$474	\$1,714
COV 60x192 (2 pieces)	\$12,961		\$13,609	\$14,257	\$24,302	\$29,162	\$32,403	15%	\$972	\$2,592	\$474	\$2,268
COV 60x240 (2 pieces)	\$13,553		\$14,230	\$14,908	\$25,411	\$30,493	\$33,881	15%	\$1,016	\$2,711	\$474	\$2,372
BOAT (BOT)												
COV 36x48x96	\$6,397		\$6,717	\$7,037	\$11,995	\$14,394	\$15,994	15%	\$480	\$1,279	\$474	\$1,120

VOLUMA CONFERENCE TABLES - (LAMINATE - PVC & WOOD ED

OVAL BASE - VENEER

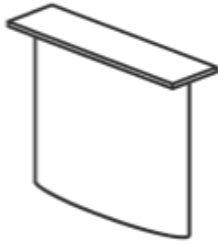

	Edge Choice: PVC & T-Mold				Edge Choice: Wood (Red Oak & Maple)			Wood Upgrade	Laminate Upgrades		Option	Light Weight
	T-15 P-10 (self) L-15	L-21 P-12	P-14	PK-2 PK-4 L-23	W-12	W-23 W-18 W-16	W-19 W-17 W-32	Upgrade: Walnut / Mahogany / Cherry	Laminate Upgrade I	Laminate Upgrade II	SPECIAL HEIGHT	Light Weight (PVC only - 1" top)
							ADD	ADD	ADD	ADD	ADD	
COV 42x54x120 (1 piece)	\$9,357		\$9,825	\$10,293	\$17,544	\$21,053	\$23,392	15%	\$702	\$1,871	\$474	\$1,637
COV 42x54x144 (1 piece)	\$9,626		\$10,108	\$10,589	\$18,049	\$21,659	\$24,066	15%	\$722	\$1,925	\$474	\$1,685
COV 48x60x192 (2 pieces)	\$12,961		\$13,609	\$14,257	\$24,302	\$29,162	\$32,403	15%	\$972	\$2,592	\$474	\$2,268
COV 48x60x240 (2 pieces)	\$13,553		\$14,230	\$14,908	\$25,411	\$30,493	\$33,881	15%	\$1,016	\$2,711	\$474	\$2,372
ARC BOAT (ARCBOT)												
COV 36x48x96	\$6,717		\$7,053	\$7,389	\$12,595	\$15,114	\$16,793	15%	\$504	\$1,343	\$474	\$1,176
COV 42x54x120 (1 piece)	\$9,825		\$10,316	\$10,807	\$18,422	\$22,106	\$24,562	15%	\$737	\$1,965	\$474	\$1,719
COV 42x54x144 (1 piece)	\$10,108		\$10,613	\$11,118	\$18,952	\$22,742	\$25,269	15%	\$758	\$2,022	\$474	\$1,769
COV 48x60x192 (2 pieces)	\$13,609		\$14,290	\$14,970	\$25,517	\$30,621	\$34,023	15%	\$1,021	\$2,722	\$474	\$2,382
COV 48x60x240 (2 pieces)	\$14,230		\$14,942	\$15,653	\$26,682	\$32,018	\$35,575	15%	\$1,067	\$2,846	\$474	\$2,490
OVAL (OVL)												
COV 42x96	\$6,284		\$6,598	\$6,912	\$11,782	\$14,138	\$15,709	15%	\$471	\$1,257	\$474	\$1,100
COV 48x96	\$6,397		\$6,717	\$7,037	\$11,995	\$14,394	\$15,994	15%	\$480	\$1,279	\$474	\$1,120
COV 48x120 (1 piece)	\$6,640		\$6,972	\$7,304	\$12,450	\$14,940	\$16,600	15%	\$498	\$1,328	\$474	\$1,162
COV 48x144 (1 piece)	\$9,459		\$9,932	\$10,405	\$17,737	\$21,284	\$23,649	15%	\$709	\$1,892	\$474	\$1,655
COV 60x120 (1 piece)	\$6,921		\$7,267	\$7,613	\$12,976	\$15,571	\$17,302	15%	\$519	\$1,384	\$474	\$1,211
COV 60x144 (1 piece)	\$9,793		\$10,283	\$10,772	\$18,362	\$22,034	\$24,482	15%	\$734	\$1,959	\$474	\$1,714

VOLUMA CONFERENCE TABLES - (VENEER)

OVAL BASE - VENEER

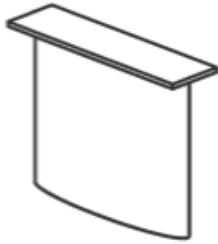

	Edge Choice: Wood (Red Oak & Maple)			Wood Upgrade	Option
	V-12	V-23 V-18 V-16	V-19 V-17 V-32	Upgrade: Walnut / Mahogany / Cherry	SPECIAL HEIGHT
				ADD	ADD
RECTANGLE (REC)					
COV 42x96	\$9,298	\$10,228	\$10,693	15%	\$474
COV 48x96	\$9,469	\$10,416	\$10,889	15%	\$474
COV 48x120 (1 piece)	\$14,097	\$15,506	\$16,211	15%	\$474
COV 48x144 (1 piece)	\$15,289	\$16,818	\$17,582	15%	\$474
COV 48x168 (2 pieces)	\$19,193	\$21,112	\$22,072	15%	\$474
COV 48x192 (2 pieces)	\$20,385	\$22,423	\$23,443	15%	\$474
COV 60x120 (1 piece)	\$15,589	\$17,147	\$17,927	15%	\$474
COV 60x144 (1 piece)	\$17,080	\$18,788	\$19,642	15%	\$474
COV 60x168 (2 pieces)	\$21,277	\$23,405	\$24,469	15%	\$474
COV 60x192 (2 pieces)	\$22,769	\$25,046	\$26,184	15%	\$474
COV 60x240 (2 pieces)	\$25,753	\$28,328	\$29,616	15%	\$474
ARC RECTANGLE (ARC REC)					
COV 42x96	\$9,763	\$10,739	\$11,228	15%	\$474
COV 48x96	\$9,942	\$10,936	\$11,434	15%	\$474
COV 48x120 (1 piece)	\$14,802	\$16,282	\$17,022	15%	\$474
COV 48x144 (1 piece)	\$16,053	\$17,658	\$18,461	15%	\$474
COV 48x168 (2 pieces)	\$20,153	\$22,168	\$23,175	15%	\$474
COV 48x192 (2 pieces)	\$21,404	\$23,545	\$24,615	15%	\$474
COV 60x120 (1 piece)	\$16,368	\$18,005	\$18,823	15%	\$474
COV 60x144 (1 piece)	\$17,934	\$19,728	\$20,625	15%	\$474
COV 60x168 (2 pieces)	\$22,341	\$24,575	\$25,692	15%	\$474
COV 60x192 (2 pieces)	\$23,907	\$26,298	\$27,494	15%	\$474
COV 60x240 (2 pieces)	\$27,040	\$29,744	\$31,096	15%	\$474
RACETRACK (RAC)					
COV 42x84	\$9,263	\$10,190	\$10,653	15%	\$474
COV 42x96	\$9,426	\$10,368	\$10,839	15%	\$474
COV 48x96	\$10,434	\$11,477	\$11,999	15%	\$474
COV 48x120 (1 piece)	\$14,631	\$16,094	\$16,825	15%	\$474
COV 48x144 (1 piece)	\$15,823	\$17,405	\$18,196	15%	\$474
COV 60x144 (1 piece)	\$17,614	\$19,376	\$20,256	15%	\$474
COV 60x192 (2 pieces)	\$23,303	\$25,633	\$26,798	15%	\$474
COV 60x240 (2 pieces)	\$26,287	\$28,915	\$30,230	15%	\$474
BOAT (BOT)					
COV 36x48x96	\$9,596	\$10,556	\$11,036	15%	\$474

VOLUMA CONFERENCE TABLES - (VENEER)

OVAL BASE - VENEER

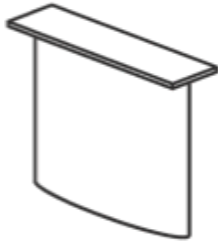

	Edge Choice: Wood (Red Oak & Maple)			Wood Upgrade	Option		
	V-12	V-23	V-19	Upgrade: Walnut / Mahogany / Cherry	SPECIAL HEIGHT		
		V-18	V-17			ADD	ADD
		V-16	V-32				
COV 42x54x120 (1 piece)	\$14,035	\$15,439	\$16,141	15%	\$474		
COV 42x54x144 (1 piece)	\$14,439	\$15,883	\$16,605	15%	\$474		
COV 48x60x192 (2 pieces)	\$19,442	\$21,386	\$22,358	15%	\$474		
COV 48x60x240 (2 pieces)	\$20,329	\$22,362	\$23,378	15%	\$474		
ARC BOAT (ARCBOT)							
COV 36x48x96	\$10,076	\$11,084	\$11,587	15%	\$474		
COV 42x54x120 (1 piece)	\$14,737	\$16,211	\$16,948	15%	\$474		
COV 42x54x144 (1 piece)	\$15,161	\$16,677	\$17,436	15%	\$474		
COV 48x60x192 (2 pieces)	\$20,414	\$22,455	\$23,476	15%	\$474		
COV 48x60x240 (2 pieces)	\$21,345	\$23,480	\$24,547	15%	\$474		
OVAL (OVL)							
COV 42x96	\$11,063	\$12,169	\$12,722	15%	\$474		
COV 48x96	\$11,063	\$12,169	\$12,722	15%	\$474		
COV 48x120 (1 piece)	\$12,832	\$14,116	\$14,757	15%	\$474		
COV 48x144 (1 piece)	\$17,029	\$18,732	\$19,584	15%	\$474		
COV 60x120 (1 piece)	\$14,690	\$16,159	\$16,893	15%	\$474		
COV 60x144 (1 piece)	\$19,252	\$21,178	\$22,140	15%	\$474		

VOLUMA CONFERENCE TABLES - (LAMINATE - PVC & WOOD ED

BOAT BASE - LAMINATE









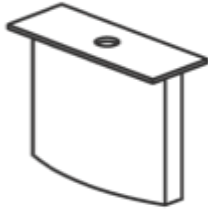









		Edge Choice: PVC & T-Mold				Edge Choice: Wood (Red Oak & Maple)			Wood Upgrade	Laminate Upgrades		Option	Light Weight
		T-15 L-21 P-10 (self) L-15	P-14 PK-2 PK-4 L-23	W-12 W-23 W-18 W-16	W-19 W-17 W-32	Upgrade: Walnut / Mahogany / Cherry	Laminate Upgrade I	Laminate Upgrade II	SPECIAL HEIGHT	Light Weight (PVC only - 1" top)			
						ADD	ADD	ADD	ADD	ADD			
RECTANGLE (REC)													
CB	42x96	\$3,482	\$3,657	\$3,831	\$6,530	\$7,835	\$8,706	15%	\$261	\$696	\$474	\$609	
CB	48x96	\$3,596	\$3,776	\$3,956	\$6,743	\$8,091	\$8,990	15%	\$270	\$719	\$474	\$629	
CB	48x120 (1 piece)	\$5,057	\$5,310	\$5,563	\$9,482	\$11,379	\$12,643	15%	\$379	\$1,011	\$474	\$885	
CB	48x144 (1 piece)	\$5,300	\$5,565	\$5,830	\$9,937	\$11,925	\$13,250	15%	\$397	\$1,060	\$474	\$927	
CB	48x168 (2 pieces)	\$6,761	\$7,099	\$7,437	\$12,677	\$15,212	\$16,903	15%	\$507	\$1,352	\$474	\$1,183	
CB	48x192 (2 pieces)	\$7,004	\$7,354	\$7,704	\$13,132	\$15,758	\$17,509	15%	\$525	\$1,401	\$474	\$1,226	
CB	60x120 (1 piece)	\$5,338	\$5,605	\$5,871	\$10,008	\$12,010	\$13,344	15%	\$400	\$1,068	\$474	\$934	
CB	60x144 (1 piece)	\$5,633	\$5,915	\$6,197	\$10,563	\$12,675	\$14,084	15%	\$423	\$1,127	\$474	\$986	
CB	60x168 (2 pieces)	\$7,148	\$7,505	\$7,862	\$13,402	\$16,082	\$17,869	15%	\$536	\$1,430	\$474	\$1,251	
CB	60x192 (2 pieces)	\$7,443	\$7,816	\$8,188	\$13,956	\$16,748	\$18,608	15%	\$558	\$1,489	\$474	\$1,303	
CB	60x240 (2 pieces)	\$8,035	\$8,437	\$8,838	\$15,065	\$18,078	\$20,087	15%	\$603	\$1,607	\$474	\$1,406	
ARC RECTANGLE (ARCREC)													
CB	42x96	\$3,657	\$3,839	\$4,022	\$6,856	\$8,227	\$9,141	15%	\$274	\$731	\$474	\$640	
CB	48x96	\$3,776	\$3,965	\$4,154	\$7,080	\$8,496	\$9,440	15%	\$283	\$755	\$474	\$661	
CB	48x120 (1 piece)	\$5,310	\$5,576	\$5,841	\$9,956	\$11,948	\$13,275	15%	\$398	\$1,062	\$474	\$929	
CB	48x144 (1 piece)	\$5,565	\$5,843	\$6,121	\$10,434	\$12,521	\$13,912	15%	\$417	\$1,113	\$474	\$974	
CB	48x168 (2 pieces)	\$7,099	\$7,454	\$7,809	\$13,311	\$15,973	\$17,748	15%	\$532	\$1,420	\$474	\$1,242	
CB	48x192 (2 pieces)	\$7,354	\$7,722	\$8,089	\$13,789	\$16,546	\$18,385	15%	\$552	\$1,471	\$474	\$1,287	
CB	60x120 (1 piece)	\$5,605	\$5,885	\$6,165	\$10,509	\$12,610	\$14,011	15%	\$420	\$1,121	\$474	\$981	
CB	60x144 (1 piece)	\$5,915	\$6,211	\$6,507	\$11,091	\$13,309	\$14,788	15%	\$444	\$1,183	\$474	\$1,035	
CB	60x168 (2 pieces)	\$7,505	\$7,880	\$8,255	\$14,072	\$16,886	\$18,762	15%	\$563	\$1,501	\$474	\$1,313	
CB	60x192 (2 pieces)	\$7,816	\$8,206	\$8,597	\$14,654	\$17,585	\$19,539	15%	\$586	\$1,563	\$474	\$1,368	
CB	60x240 (2 pieces)	\$8,437	\$8,858	\$9,280	\$15,819	\$18,982	\$21,091	15%	\$633	\$1,687	\$474	\$1,476	
RACETRACK (RAC)													
CB	42x84	\$3,459	\$3,632	\$3,805	\$6,486	\$7,783	\$8,648	15%	\$259	\$692	\$474	\$605	
CB	42x96	\$3,567	\$3,746	\$3,924	\$6,689	\$8,026	\$8,918	15%	\$268	\$713	\$474	\$624	
CB	48x96	\$3,681	\$3,865	\$4,049	\$6,902	\$8,282	\$9,203	15%	\$276	\$736	\$474	\$644	
CB	48x120 (1 piece)	\$5,142	\$5,399	\$5,656	\$9,642	\$11,570	\$12,855	15%	\$386	\$1,028	\$474	\$900	
CB	48x144 (1 piece)	\$5,385	\$5,654	\$5,923	\$10,097	\$12,116	\$13,462	15%	\$404	\$1,077	\$474	\$942	
CB	60x144 (1 piece)	\$5,718	\$6,004	\$6,290	\$10,722	\$12,866	\$14,296	15%	\$429	\$1,144	\$474	\$1,001	
CB	60x192 (2 pieces)	\$7,528	\$7,905	\$8,281	\$14,115	\$16,939	\$18,821	15%	\$565	\$1,506	\$474	\$1,317	
CB	60x240 (2 pieces)	\$8,120	\$8,526	\$8,932	\$15,225	\$18,269	\$20,299	15%	\$609	\$1,624	\$474	\$1,421	
BOAT (BOT)													
CB	36x48x96	\$3,681	\$3,865	\$4,049	\$6,902	\$8,282	\$9,203	15%	\$276	\$736	\$474	\$644	

VOLUMA CONFERENCE TABLES - (LAMINATE - PVC & WOOD ED

BOAT BASE - LAMINATE









		Edge Choice: PVC & T-Mold				Edge Choice: Wood (Red Oak & Maple)			Wood Upgrade	Laminate Upgrades		Option	Light Weight
		 T-15	 L-21	 P-14	 PK-2	 W-12	 W-23	 W-19	Upgrade: Walnut / Mahogany / Cherry	Laminate Upgrade I	Laminate Upgrade II	SPECIAL HEIGHT	Light Weight (PVC only - 1" top)
		 P-10 (self)	 P-12		 PK-4	 W-18	 W-17	ADD		ADD	ADD		
		 L-15			 L-23	 W-16	 W-32						
CB	42x54x120 (1 piece)	\$5,282		\$5,546	\$5,811	\$9,904	\$11,885	\$13,206	15%	\$396	\$1,056	\$474	\$924
CB	42x54x144 (1 piece)	\$5,552		\$5,829	\$6,107	\$10,409	\$12,491	\$13,879	15%	\$416	\$1,110	\$474	\$972
CB	48x60x192 (2 pieces)	\$7,528		\$7,905	\$8,281	\$14,115	\$16,939	\$18,821	15%	\$565	\$1,506	\$474	\$1,317
CB	48x60x240 (2 pieces)	\$8,120		\$8,526	\$8,932	\$15,225	\$18,269	\$20,299	15%	\$609	\$1,624	\$474	\$1,421
ARC BOAT (ARCBOT)													
CB	36x48x96	\$3,865		\$4,058	\$4,252	\$7,247	\$8,696	\$9,663	15%	\$290	\$773	\$474	\$676
CB	42x54x120 (1 piece)	\$5,546		\$5,824	\$6,101	\$10,400	\$12,480	\$13,866	15%	\$416	\$1,109	\$474	\$971
CB	42x54x144 (1 piece)	\$5,829		\$6,121	\$6,412	\$10,930	\$13,116	\$14,573	15%	\$437	\$1,166	\$474	\$1,020
CB	48x60x192 (2 pieces)	\$7,905		\$8,300	\$8,695	\$14,821	\$17,785	\$19,762	15%	\$593	\$1,581	\$474	\$1,383
CB	48x60x240 (2 pieces)	\$8,526		\$8,952	\$9,378	\$15,986	\$19,183	\$21,314	15%	\$639	\$1,705	\$474	\$1,492
OVAL (OVL)													
CB	42x96	\$3,567		\$3,746	\$3,924	\$6,689	\$8,026	\$8,918	15%	\$268	\$713	\$474	\$624
CB	48x96	\$3,681		\$3,865	\$4,049	\$6,902	\$8,282	\$9,203	15%	\$276	\$736	\$474	\$644
CB	48x120 (1 piece)	\$3,924		\$4,120	\$4,316	\$7,357	\$8,828	\$9,809	15%	\$294	\$785	\$474	\$687
CB	48x144 (1 piece)	\$5,385		\$5,654	\$5,923	\$10,097	\$12,116	\$13,462	15%	\$404	\$1,077	\$474	\$942
CB	60x120 (1 piece)	\$4,204		\$4,414	\$4,625	\$7,883	\$9,459	\$10,511	15%	\$315	\$841	\$474	\$736
CB	60x144 (1 piece)	\$5,718		\$6,004	\$6,290	\$10,722	\$12,866	\$14,296	15%	\$429	\$1,144	\$474	\$1,001

VOLUMA CONFERENCE TABLES - (VENE

BOAT BASE - LAMINATE









	Edge Choice: Wood (Red Oak & Maple)			Wood Upgrade	Option
	 V-12	 V-23  V-18  V-16	 V-19  V-17  V-32	Upgrade: Walnut / Mahogany / Cherry ADD	SPECIAL HEIGHT ADD
RECTANGLE (REC)					
CB 42x96	\$6,094	\$6,704	\$7,008	15%	\$474
CB 48x96	\$6,293	\$6,923	\$7,237	15%	\$474
CB 48x120 (1 piece)	\$9,808	\$10,788	\$11,279	15%	\$474
CB 48x144 (1 piece)	\$11,000	\$12,100	\$12,650	15%	\$474
CB 48x168 (2 pieces)	\$13,474	\$14,822	\$15,495	15%	\$474
CB 48x192 (2 pieces)	\$14,666	\$16,133	\$16,866	15%	\$474
CB 60x120 (1 piece)	\$11,299	\$12,429	\$12,994	15%	\$474
CB 60x144 (1 piece)	\$12,791	\$14,070	\$14,710	15%	\$474
CB 60x168 (2 pieces)	\$15,558	\$17,114	\$17,892	15%	\$474
CB 60x192 (2 pieces)	\$17,050	\$18,755	\$19,608	15%	\$474
CB 60x240 (2 pieces)	\$20,034	\$22,037	\$23,039	15%	\$474
ARC RECTANGLE (ARC REC)					
CB 42x96	\$6,399	\$7,039	\$7,359	15%	\$474
CB 48x96	\$6,608	\$7,269	\$7,599	15%	\$474
CB 48x120 (1 piece)	\$10,298	\$11,328	\$11,843	15%	\$474
CB 48x144 (1 piece)	\$11,550	\$12,705	\$13,282	15%	\$474
CB 48x168 (2 pieces)	\$14,148	\$15,563	\$16,270	15%	\$474
CB 48x192 (2 pieces)	\$15,400	\$16,939	\$17,709	15%	\$474
CB 60x120 (1 piece)	\$11,864	\$13,051	\$13,644	15%	\$474
CB 60x144 (1 piece)	\$13,431	\$14,774	\$15,446	15%	\$474
CB 60x168 (2 pieces)	\$16,336	\$17,970	\$18,787	15%	\$474
CB 60x192 (2 pieces)	\$17,903	\$19,693	\$20,588	15%	\$474
CB 60x240 (2 pieces)	\$21,036	\$23,139	\$24,191	15%	\$474
RACETRACK (RAC)					
CB 42x84	\$6,054	\$6,659	\$6,962	15%	\$474
CB 42x96	\$6,243	\$6,867	\$7,179	15%	\$474
CB 48x96	\$7,574	\$8,332	\$8,711	15%	\$474
CB 48x120 (1 piece)	\$10,341	\$11,376	\$11,893	15%	\$474
CB 48x144 (1 piece)	\$11,534	\$12,687	\$13,264	15%	\$474
CB 60x144 (1 piece)	\$13,325	\$14,658	\$15,324	15%	\$474
CB 60x192 (2 pieces)	\$17,584	\$19,342	\$20,222	15%	\$474
CB 60x240 (2 pieces)	\$20,568	\$22,625	\$23,653	15%	\$474
BOAT (BOT)					
CB 36x48x96	\$6,442	\$7,086	\$7,408	15%	\$474

VOLUMA CONFERENCE TABLES - (VENE)

BOAT BASE - LAMINATE



		Edge Choice: Wood (Red Oak & Maple)			Wood Upgrade	Option	
		 V-12	 V-23	 V-19	Upgrade: Walnut / Mahogany / Cherry	SPECIAL HEIGHT	
		 V-18	 V-17	ADD			ADD
		 V-16	 V-32				
CB	42x54x120 (1 piece)	\$9,244	\$10,169	\$10,631	15%	\$474	
CB	42x54x144 (1 piece)	\$9,715	\$10,687	\$11,173	15%	\$474	
CB	48x60x192 (2 pieces)	\$13,174	\$14,492	\$15,151	15%	\$474	
CB	48x60x240 (2 pieces)	CF	CF	CF	CF	\$474	
ARC BOAT (ARCBOT)							
CB	36x48x96	\$6,764	\$7,440	\$7,779	15%	\$474	
CB	42x54x120 (1 piece)	\$9,706	\$10,677	\$11,162	15%	\$474	
CB	42x54x144 (1 piece)	\$10,201	\$11,221	\$11,731	15%	\$474	
CB	48x60x192 (2 pieces)	\$13,833	\$15,216	\$15,908	15%	\$474	
CB	48x60x240 (2 pieces)	\$14,920	\$16,412	\$17,158	15%	\$474	
OVAL (OVL)							
CB	42x96	\$8,203	\$9,024	\$9,434	15%	\$474	
CB	48x96	\$8,203	\$9,024	\$9,434	15%	\$474	
CB	48x120 (1 piece)	\$9,973	\$10,970	\$11,469	15%	\$474	
CB	48x144 (1 piece)	\$12,740	\$14,014	\$14,651	15%	\$474	
CB	60x120 (1 piece)	\$11,831	\$13,014	\$13,605	15%	\$474	
CB	60x144 (1 piece)	\$14,963	\$16,460	\$17,208	15%	\$474	

VOLUMA CONFERENCE TABLES - (LAMINATE - PVC & WOOD ED

BOAT BASE - VENEER



	Edge Choice: PVC & T-Mold			Edge Choice: Wood (Red Oak & Maple)			Wood Upgrade	Laminate Upgrades		Option	Light Weight				
								Upgrade: Walnut / Mahogany / Cherry	Laminate Upgrade I	Laminate Upgrade II	SPECIAL HEIGHT	Light Weight (PVC only - 1" top)			
							ADD						ADD	ADD	ADD
RECTANGLE (REC)															
CBV 42x96	\$6,199	\$6,509	\$6,819	\$11,623	\$13,947	\$15,497	15%	\$465	\$1,240	\$474	\$1,085				
CBV 48x96	\$6,313	\$6,628	\$6,944	\$11,836	\$14,203	\$15,781	15%	\$473	\$1,263	\$474	\$1,105				
CBV 48x120 (1 piece)	\$9,132	\$9,588	\$10,045	\$17,122	\$20,547	\$22,830	15%	\$685	\$1,826	\$474	\$1,598				
CBV 48x144 (1 piece)	\$9,375	\$9,843	\$10,312	\$17,577	\$21,093	\$23,436	15%	\$703	\$1,875	\$474	\$1,641				
CBV 48x168 (2 pieces)	\$12,194	\$12,804	\$13,413	\$22,864	\$27,436	\$30,485	15%	\$915	\$2,439	\$474	\$2,134				
CBV 48x192 (2 pieces)	\$12,437	\$13,058	\$13,680	\$23,319	\$27,982	\$31,091	15%	\$933	\$2,487	\$474	\$2,176				
CBV 60x120 (1 piece)	\$9,412	\$9,883	\$10,354	\$17,648	\$21,178	\$23,531	15%	\$706	\$1,882	\$474	\$1,647				
CBV 60x144 (1 piece)	\$9,708	\$10,193	\$10,679	\$18,203	\$21,843	\$24,270	15%	\$728	\$1,942	\$474	\$1,699				
CBV 60x168 (2 pieces)	\$12,580	\$13,209	\$13,838	\$23,588	\$28,306	\$31,451	15%	\$944	\$2,516	\$474	\$2,202				
CBV 60x192 (2 pieces)	\$12,876	\$13,520	\$14,164	\$24,143	\$28,971	\$32,190	15%	\$966	\$2,575	\$474	\$2,253				
CBV 60x240 (2 pieces)	\$13,468	\$14,141	\$14,814	\$25,252	\$30,302	\$33,669	15%	\$1,010	\$2,694	\$474	\$2,357				
ARC RECTANGLE (ARCREC)															
CBV 42x96	\$6,509	\$6,834	\$7,160	\$12,204	\$14,645	\$16,272	15%	\$488	\$1,302	\$474	\$1,139				
CBV 48x96	\$6,628	\$6,960	\$7,291	\$12,428	\$14,913	\$16,570	15%	\$497	\$1,326	\$474	\$1,160				
CBV 48x120 (1 piece)	\$9,588	\$10,068	\$10,547	\$17,978	\$21,574	\$23,971	15%	\$719	\$1,918	\$474	\$1,678				
CBV 48x144 (1 piece)	\$9,843	\$10,335	\$10,828	\$18,456	\$22,147	\$24,608	15%	\$738	\$1,969	\$474	\$1,723				
CBV 48x168 (2 pieces)	\$12,804	\$13,444	\$14,084	\$24,007	\$28,808	\$32,009	15%	\$960	\$2,561	\$474	\$2,241				
CBV 48x192 (2 pieces)	\$13,058	\$13,711	\$14,364	\$24,485	\$29,381	\$32,646	15%	\$979	\$2,612	\$474	\$2,285				
CBV 60x120 (1 piece)	\$9,883	\$10,377	\$10,871	\$18,530	\$22,237	\$24,707	15%	\$741	\$1,977	\$474	\$1,730				
CBV 60x144 (1 piece)	\$10,193	\$10,703	\$11,213	\$19,113	\$22,935	\$25,484	15%	\$765	\$2,039	\$474	\$1,784				
CBV 60x168 (2 pieces)	\$13,209	\$13,870	\$14,530	\$24,768	\$29,721	\$33,024	15%	\$991	\$2,642	\$474	\$2,312				
CBV 60x192 (2 pieces)	\$13,520	\$14,196	\$14,872	\$25,350	\$30,420	\$33,800	15%	\$1,014	\$2,704	\$474	\$2,366				
CBV 60x240 (2 pieces)	\$14,141	\$14,848	\$15,555	\$26,514	\$31,817	\$35,353	15%	\$1,061	\$2,828	\$474	\$2,475				
RACETRACK (RAC)															
CBV 42x84	\$6,176	\$6,484	\$6,793	\$11,579	\$13,895	\$15,439	15%	\$463	\$1,235	\$474	\$1,081				
CBV 42x96	\$6,284	\$6,598	\$6,912	\$11,782	\$14,138	\$15,709	15%	\$471	\$1,257	\$474	\$1,100				
CBV 48x96	\$6,397	\$6,717	\$7,037	\$11,995	\$14,394	\$15,994	15%	\$480	\$1,279	\$474	\$1,120				
CBV 48x120 (1 piece)	\$9,217	\$9,678	\$10,138	\$17,281	\$20,738	\$23,042	15%	\$691	\$1,843	\$474	\$1,613				
CBV 48x144 (1 piece)	\$9,459	\$9,932	\$10,405	\$17,737	\$21,284	\$23,649	15%	\$709	\$1,892	\$474	\$1,655				
CBV 60x144 (1 piece)	\$9,793	\$10,283	\$10,772	\$18,362	\$22,034	\$24,482	15%	\$734	\$1,959	\$474	\$1,714				
CBV 60x192 (2 pieces)	\$12,961	\$13,609	\$14,257	\$24,302	\$29,162	\$32,403	15%	\$972	\$2,592	\$474	\$2,268				
CBV 60x240 (2 pieces)	\$13,553	\$14,230	\$14,908	\$25,411	\$30,493	\$33,881	15%	\$1,016	\$2,711	\$474	\$2,372				
BOAT (BOT)															
CBV 36x48x96	\$6,397	\$6,717	\$7,037	\$11,995	\$14,394	\$15,994	15%	\$480	\$1,279	\$474	\$1,120				

VOLUMA CONFERENCE TABLES - (LAMINATE - PVC & WOOD ED

BOAT BASE - VENEER









	Edge Choice: PVC & T-Mold				Edge Choice: Wood (Red Oak & Maple)			Wood Upgrade	Laminate Upgrades		Option	Light Weight
	T-15 P-10 (self) L-15	L-21 P-12	P-14	PK-2 PK-4 L-23	W-12	W-23 W-18 W-16	W-19 W-17 W-32	Upgrade: Walnut / Mahogany / Cherry	Laminate Upgrade I	Laminate Upgrade II	SPECIAL HEIGHT	Light Weight (PVC only - 1" top)
								ADD	ADD	ADD	ADD	ADD
CBV 42x54x120 (1 piece)	\$9,357		\$9,825	\$10,293	\$17,544	\$21,053	\$23,392	15%	\$702	\$1,871	\$474	\$1,637
CBV 42x54x144 (1 piece)	\$9,626		\$10,108	\$10,589	\$18,049	\$21,659	\$24,066	15%	\$722	\$1,925	\$474	\$1,685
CBV 48x60x192 (2 pieces)	\$12,961		\$13,609	\$14,257	\$24,302	\$29,162	\$32,403	15%	\$972	\$2,592	\$474	\$2,268
CBV 48x60x240 (2 pieces)	\$13,553		\$14,230	\$14,908	\$25,411	\$30,493	\$33,881	15%	\$1,016	\$2,711	\$474	\$2,372
ARC BOAT (ARCBOT)												
CBV 36x48x96	\$6,717		\$7,053	\$7,389	\$12,595	\$15,114	\$16,793	15%	\$504	\$1,343	\$474	\$1,176
CBV 42x54x120 (1 piece)	\$9,825		\$10,316	\$10,807	\$18,422	\$22,106	\$24,562	15%	\$737	\$1,965	\$474	\$1,719
CBV 42x54x144 (1 piece)	\$10,108		\$10,613	\$11,118	\$18,952	\$22,742	\$25,269	15%	\$758	\$2,022	\$474	\$1,769
CBV 48x60x192 (2 pieces)	\$13,609		\$14,290	\$14,970	\$25,517	\$30,621	\$34,023	15%	\$1,021	\$2,722	\$474	\$2,382
CBV 48x60x240 (2 pieces)	\$14,230		\$14,942	\$15,653	\$26,682	\$32,018	\$35,575	15%	\$1,067	\$2,846	\$474	\$2,490
OVAL (OVL)												
CBV 42x96	\$6,284		\$6,598	\$6,912	\$11,782	\$14,138	\$15,709	15%	\$471	\$1,257	\$474	\$1,100
CBV 48x96	\$6,397		\$6,717	\$7,037	\$11,995	\$14,394	\$15,994	15%	\$480	\$1,279	\$474	\$1,120
CBV 48x120 (1 piece)	\$6,640		\$6,972	\$7,304	\$12,450	\$14,940	\$16,600	15%	\$498	\$1,328	\$474	\$1,162
CBV 48x144 (1 piece)	\$9,459		\$9,932	\$10,405	\$17,737	\$21,284	\$23,649	15%	\$709	\$1,892	\$474	\$1,655
CBV 60x120 (1 piece)	\$6,921		\$7,267	\$7,613	\$12,976	\$15,571	\$17,302	15%	\$519	\$1,384	\$474	\$1,211
CBV 60x144 (1 piece)	\$9,793		\$10,283	\$10,772	\$18,362	\$22,034	\$24,482	15%	\$734	\$1,959	\$474	\$1,714

VOLUMA CONFERENCE TABLES - (VENEER)

BOAT BASE - VENEER









	Edge Choice: Wood (Red Oak & Maple)			Wood Upgrade	Option
	 V-12	 V-23  V-18	 V-19  V-17  V-16  V-32	Upgrade: Walnut / Mahogany / Cherry ADD	SPECIAL HEIGHT ADD
RECTANGLE (REC)					
CBV 42x96	\$10,848	\$11,933	\$12,475	15%	\$474
CBV 48x96	\$11,047	\$12,152	\$12,704	15%	\$474
CBV 48x120 (1 piece)	\$14,097	\$15,506	\$16,211	15%	\$474
CBV 48x144 (1 piece)	\$15,289	\$16,818	\$17,582	15%	\$474
CBV 48x168 (2 pieces)	\$19,193	\$21,112	\$22,072	15%	\$474
CBV 48x192 (2 pieces)	\$20,385	\$22,423	\$23,443	15%	\$474
CBV 60x120 (1 piece)	\$15,589	\$17,147	\$17,927	15%	\$474
CBV 60x144 (1 piece)	\$17,080	\$18,788	\$19,642	15%	\$474
CBV 60x168 (2 pieces)	\$21,277	\$23,405	\$24,469	15%	\$474
CBV 60x192 (2 pieces)	\$22,769	\$25,046	\$26,184	15%	\$474
CBV 60x240 (2 pieces)	\$25,753	\$28,328	\$29,616	15%	\$474
ARC RECTANGLE (ARCREC)					
CBV 42x96	\$11,390	\$12,529	\$13,099	15%	\$474
CBV 48x96	\$11,599	\$12,759	\$13,339	15%	\$474
CBV 48x120 (1 piece)	\$14,802	\$16,282	\$17,022	15%	\$474
CBV 48x144 (1 piece)	\$16,053	\$17,658	\$18,461	15%	\$474
CBV 48x168 (2 pieces)	\$20,153	\$22,168	\$23,175	15%	\$474
CBV 48x192 (2 pieces)	\$21,404	\$23,545	\$24,615	15%	\$474
CBV 60x120 (1 piece)	\$16,368	\$18,005	\$18,823	15%	\$474
CBV 60x144 (1 piece)	\$17,934	\$19,728	\$20,625	15%	\$474
CBV 60x168 (2 pieces)	\$22,341	\$24,575	\$25,692	15%	\$474
CBV 60x192 (2 pieces)	\$23,907	\$26,298	\$27,494	15%	\$474
CBV 60x240 (2 pieces)	\$27,040	\$29,744	\$31,096	15%	\$474
RACETRACK (RAC)					
CBV 42x84	\$10,807	\$11,888	\$12,428	15%	\$474
CBV 42x96	\$10,997	\$12,096	\$12,646	15%	\$474
CBV 48x96	\$10,434	\$11,477	\$11,999	15%	\$474
CBV 48x120 (1 piece)	\$14,631	\$16,094	\$16,825	15%	\$474
CBV 48x144 (1 piece)	\$15,823	\$17,405	\$18,196	15%	\$474
CBV 60x144 (1 piece)	\$17,614	\$19,376	\$20,256	15%	\$474
CBV 60x192 (2 pieces)	\$23,303	\$25,633	\$26,798	15%	\$474
CBV 60x240 (2 pieces)	\$26,287	\$28,915	\$30,230	15%	\$474
BOAT (BOT)					
CBV 36x48x96	\$11,196	\$12,315	\$12,875	15%	\$474

VOLUMA CONFERENCE TABLES - (VENEER)

BOAT BASE - VENEER



	Edge Choice: Wood (Red Oak & Maple)			Wood Upgrade	Option
	 V-12	 V-23	 V-19	Upgrade: Walnut / Mahogany / Cherry	SPECIAL HEIGHT
		 V-18	 V-17		
		 V-16	 V-32		
CBV 42x54x120 (1 piece)	\$16,375	\$18,012	\$18,831	15%	\$474
CBV 42x54x144 (1 piece)	\$16,846	\$18,530	\$19,373	15%	\$474
CBV 48x60x192 (2 pieces)	\$22,682	\$24,950	\$26,084	15%	\$474
CBV 48x60x240 (2 pieces)	\$23,717	\$26,089	\$27,275	15%	\$474
ARC BOAT (ARCBOT)					
CBV 36x48x96	\$11,755	\$12,931	\$13,519	15%	\$474
CBV 42x54x120 (1 piece)	\$17,193	\$18,913	\$19,773	15%	\$474
CBV 42x54x144 (1 piece)	\$17,688	\$19,457	\$20,341	15%	\$474
CBV 48x60x192 (2 pieces)	\$23,816	\$26,198	\$27,388	15%	\$474
CBV 48x60x240 (2 pieces)	\$24,903	\$27,393	\$28,638	15%	\$474
OVAL (OVL)					
CBV 42x96	\$11,063	\$12,169	\$12,722	15%	\$474
CBV 48x96	\$11,063	\$12,169	\$12,722	15%	\$474
CBV 48x120 (1 piece)	\$12,832	\$14,116	\$14,757	15%	\$474
CBV 48x144 (1 piece)	\$17,029	\$18,732	\$19,584	15%	\$474
CBV 60x120 (1 piece)	\$14,690	\$16,159	\$16,893	15%	\$474
CBV 60x144 (1 piece)	\$19,252	\$21,178	\$22,140	15%	\$474

VOLUMA CONFERENCE TABLES - (LAMINATE - PVC & WOOD ED

ARCH BASE - LAMINATE

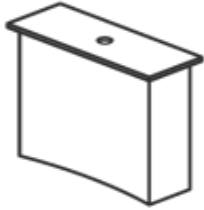

		Edge Choice: PVC & T-Mold				Edge Choice: Wood (Red Oak & Maple)			Wood Upgrade	Laminate Upgrades		Option	Light Weight
		T-15	L-21	P-14	PK-2	W-12	W-23	W-19	Upgrade: Walnut / Mahogany / Cherry	Laminate Upgrade I	Laminate Upgrade II	SPECIAL HEIGHT	Light Weight (PVC only - 1" top)
		P-10 (self)	P-12		PK-4	W-18	W-17	ADD		ADD	ADD	ADD	
		L-15			L-23	W-16	W-32						
RECTANGLE (REC)													
CA	42x96	\$3,482	\$3,657	\$3,831	\$6,530	\$7,835	\$8,706	15%	\$261	\$696	\$474	\$609	
CA	48x96	\$3,596	\$3,776	\$3,956	\$6,743	\$8,091	\$8,990	15%	\$270	\$719	\$474	\$629	
CA	48x120 (1 piece)	\$5,057	\$5,310	\$5,563	\$9,482	\$11,379	\$12,643	15%	\$379	\$1,011	\$474	\$885	
CA	48x144 (1 piece)	\$5,300	\$5,565	\$5,830	\$9,937	\$11,925	\$13,250	15%	\$397	\$1,060	\$474	\$927	
CA	48x168 (2 pieces)	\$6,761	\$7,099	\$7,437	\$12,677	\$15,212	\$16,903	15%	\$507	\$1,352	\$474	\$1,183	
CA	48x192 (2 pieces)	\$7,004	\$7,354	\$7,704	\$13,132	\$15,758	\$17,509	15%	\$525	\$1,401	\$474	\$1,226	
CA	60x120 (1 piece)	\$5,338	\$5,605	\$5,871	\$10,008	\$12,010	\$13,344	15%	\$400	\$1,068	\$474	\$934	
CA	60x144 (1 piece)	\$4,160	\$4,368	\$4,576	\$7,800	\$9,360	\$10,400	15%	\$312	\$832	\$474	\$728	
CA	60x168 (2 pieces)	\$7,148	\$7,505	\$7,862	\$13,402	\$16,082	\$17,869	15%	\$536	\$1,430	\$474	\$1,251	
CA	60x192 (2 pieces)	\$7,443	\$7,816	\$8,188	\$13,956	\$16,748	\$18,608	15%	\$558	\$1,489	\$474	\$1,303	
CA	60x240 (2 pieces)	\$8,035	\$8,437	\$8,838	\$15,065	\$18,078	\$20,087	15%	\$603	\$1,607	\$474	\$1,406	
ARC RECTANGLE (ARC REC)													
CA	42x96	\$3,657	\$3,839	\$4,022	\$6,856	\$8,227	\$9,141	15%	\$274	\$731	\$474	\$640	
CA	48x96	\$3,776	\$3,965	\$4,154	\$7,080	\$8,496	\$9,440	15%	\$283	\$755	\$474	\$661	
CA	48x120 (1 piece)	\$5,310	\$5,576	\$5,841	\$9,956	\$11,948	\$13,275	15%	\$398	\$1,062	\$474	\$929	
CA	48x144 (1 piece)	\$5,565	\$5,843	\$6,121	\$10,434	\$12,521	\$13,912	15%	\$417	\$1,113	\$474	\$974	
CA	48x168 (2 pieces)	\$7,099	\$7,454	\$7,809	\$13,311	\$15,973	\$17,748	15%	\$532	\$1,420	\$474	\$1,242	
CA	48x192 (2 pieces)	\$7,354	\$7,722	\$8,089	\$13,789	\$16,546	\$18,385	15%	\$552	\$1,471	\$474	\$1,287	
CA	60x120 (1 piece)	\$5,605	\$5,885	\$6,165	\$10,509	\$12,610	\$14,011	15%	\$420	\$1,121	\$474	\$981	
CA	60x144 (1 piece)	\$5,915	\$6,211	\$6,507	\$11,091	\$13,309	\$14,788	15%	\$444	\$1,183	\$474	\$1,035	
CA	60x168 (2 pieces)	\$7,505	\$7,880	\$8,255	\$14,072	\$16,886	\$18,762	15%	\$563	\$1,501	\$474	\$1,313	
CA	60x192 (2 pieces)	\$7,816	\$8,206	\$8,597	\$14,654	\$17,585	\$19,539	15%	\$586	\$1,563	\$474	\$1,368	
CA	60x240 (2 pieces)	\$8,437	\$8,858	\$9,280	\$15,819	\$18,982	\$21,091	15%	\$633	\$1,687	\$474	\$1,476	
RACETRACK (RAC)													
CA	42x84	\$3,459	\$3,632	\$3,805	\$6,486	\$7,783	\$8,648	15%	\$259	\$692	\$474	\$605	
CA	42x96	\$3,567	\$3,746	\$3,924	\$6,689	\$8,026	\$8,918	15%	\$268	\$713	\$474	\$624	
CA	48x96	\$3,681	\$3,865	\$4,049	\$6,902	\$8,282	\$9,203	15%	\$276	\$736	\$474	\$644	
CA	48x120 (1 piece)	\$5,142	\$5,399	\$5,656	\$9,642	\$11,570	\$12,855	15%	\$386	\$1,028	\$474	\$900	
CA	48x144 (1 piece)	\$5,385	\$5,654	\$5,923	\$10,097	\$12,116	\$13,462	15%	\$404	\$1,077	\$474	\$942	
CA	60x144 (1 piece)	\$5,718	\$6,004	\$6,290	\$10,722	\$12,866	\$14,296	15%	\$429	\$1,144	\$474	\$1,001	
CA	60x192 (2 pieces)	\$7,528	\$7,905	\$8,281	\$14,115	\$16,939	\$18,821	15%	\$565	\$1,506	\$474	\$1,317	
CA	60x240 (2 pieces)	\$8,120	\$8,526	\$8,932	\$15,225	\$18,269	\$20,299	15%	\$609	\$1,624	\$474	\$1,421	
BOAT (BOT)													
CA	36x48x96	\$3,681	\$3,865	\$4,049	\$6,902	\$8,282	\$9,203	15%	\$276	\$736	\$474	\$644	

VOLUMA CONFERENCE TABLES - (LAMINATE - PVC & WOOD ED

ARCH BASE - LAMINATE

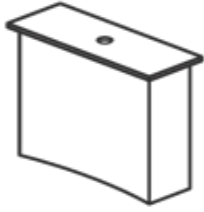

		Edge Choice: PVC & T-Mold				Edge Choice: Wood (Red Oak & Maple)			Wood Upgrade	Laminate Upgrades	Option	Light Weight	
		T-15	L-21	P-14	PK-2	W-12	W-23	W-19	Upgrade: Walnut / Mahogany / Cherry	Laminate Upgrade I	Laminate Upgrade II	SPECIAL HEIGHT	Light Weight (PVC only - 1" top)
		P-10 (self)	P-12		PK-4	W-18	W-17	ADD					
		L-15			L-23	W-16	W-32						
CA	42x54x120 (1 piece)	\$5,282		\$5,546	\$5,811	\$9,904	\$11,885	\$13,206	15%	\$396	\$1,056	\$474	\$924
CA	42x54x144 (1 piece)	\$5,552		\$5,829	\$6,107	\$10,409	\$12,491	\$13,879	15%	\$416	\$1,110	\$474	\$972
CA	48x60x192 (2 pieces)	\$7,528		\$7,905	\$8,281	\$14,115	\$16,939	\$18,821	15%	\$565	\$1,506	\$474	\$1,317
CA	48x60x240 (2 pieces)	\$8,120		\$8,526	\$8,932	\$15,225	\$18,269	\$20,299	15%	\$609	\$1,624	\$474	\$1,421
ARC BOAT (ARCBOT)													
CA	36x48x96	\$3,865		\$4,058	\$4,252	\$7,247	\$8,696	\$9,663	15%	\$290	\$773	\$474	\$676
CA	42x54x120 (1 piece)	\$5,546		\$5,824	\$6,101	\$10,400	\$12,480	\$13,866	15%	\$416	\$1,109	\$474	\$971
CA	42x54x144 (1 piece)	\$5,829		\$6,121	\$6,412	\$10,930	\$13,116	\$14,573	15%	\$437	\$1,166	\$474	\$1,020
CA	48x60x192 (2 pieces)	\$7,905		\$8,300	\$8,695	\$14,821	\$17,785	\$19,762	15%	\$593	\$1,581	\$474	\$1,383
CA	48x60x240 (2 pieces)	\$8,526		\$8,952	\$9,378	\$15,986	\$19,183	\$21,314	15%	\$639	\$1,705	\$474	\$1,492
OVAL (OVL)													
CA	42x96	\$3,567		\$3,746	\$3,924	\$6,689	\$8,026	\$8,918	15%	\$268	\$713	\$474	\$624
CA	48x96	\$3,681		\$3,865	\$4,049	\$6,902	\$8,282	\$9,203	15%	\$276	\$736	\$474	\$644
CA	48x120 (1 piece)	\$3,924		\$4,120	\$4,316	\$7,357	\$8,828	\$9,809	15%	\$294	\$785	\$474	\$687
CA	48x144 (1 piece)	\$5,385		\$5,654	\$5,923	\$10,097	\$12,116	\$13,462	15%	\$404	\$1,077	\$474	\$942
CA	60x120 (1 piece)	\$4,204		\$4,414	\$4,625	\$7,883	\$9,459	\$10,511	15%	\$315	\$841	\$474	\$736
CA	60x144 (1 piece)	\$5,718		\$6,004	\$6,290	\$10,722	\$12,866	\$14,296	15%	\$429	\$1,144	\$474	\$1,001

VOLUMA CONFERENCE TABLES - (VENE

ARCH BASE - LAMINATE

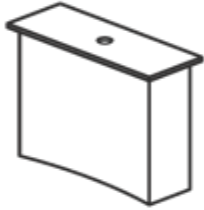





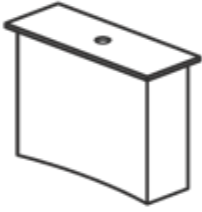

	Edge Choice: Wood (Red Oak & Maple)			Wood Upgrade	Option
	V-12	V-23 V-18 V-16	V-19 V-17 V-32	Upgrade: Walnut / Mahogany / Cherry	SPECIAL HEIGHT
				ADD	ADD
RECTANGLE (REC)					
CA 42x96	\$6,094	\$6,704	\$7,008	15%	\$474
CA 48x96	\$6,293	\$6,923	\$7,237	15%	\$474
CA 48x120 (1 piece)	\$9,808	\$10,788	\$11,279	15%	\$474
CA 48x144 (1 piece)	\$11,000	\$12,100	\$12,650	15%	\$474
CA 48x168 (2 pieces)	\$13,474	\$14,822	\$15,495	15%	\$474
CA 48x192 (2 pieces)	\$14,666	\$16,133	\$16,866	15%	\$474
CA 60x120 (1 piece)	\$11,299	\$12,429	\$12,994	15%	\$474
CA 60x144 (1 piece)	\$12,791	\$14,070	\$14,710	15%	\$474
CA 60x168 (2 pieces)	\$15,558	\$17,114	\$17,892	15%	\$474
CA 60x192 (2 pieces)	\$17,050	\$18,755	\$19,608	15%	\$474
CA 60x240 (2 pieces)	\$20,034	\$22,037	\$23,039	15%	\$474
ARC RECTANGLE (ARC REC)					
CA 42x96	\$6,399	\$7,039	\$7,359	15%	\$474
CA 48x96	\$6,608	\$7,269	\$7,599	15%	\$474
CA 48x120 (1 piece)	\$10,298	\$11,328	\$11,843	15%	\$474
CA 48x144 (1 piece)	\$11,550	\$12,705	\$13,282	15%	\$474
CA 48x168 (2 pieces)	\$14,148	\$15,563	\$16,270	15%	\$474
CA 48x192 (2 pieces)	\$15,400	\$16,939	\$17,709	15%	\$474
CA 60x120 (1 piece)	\$11,864	\$13,051	\$13,644	15%	\$474
CA 60x144 (1 piece)	\$13,431	\$14,774	\$15,446	15%	\$474
CA 60x168 (2 pieces)	\$16,336	\$17,970	\$18,787	15%	\$474
CA 60x192 (2 pieces)	\$17,903	\$19,693	\$20,588	15%	\$474
CA 60x240 (2 pieces)	\$21,036	\$23,139	\$24,191	15%	\$474
RACETRACK (RAC)					
CA 42x84	\$6,054	\$6,659	\$6,962	15%	\$474
CA 42x96	\$6,243	\$6,867	\$7,179	15%	\$474
CA 48x96	\$7,574	\$8,332	\$8,711	15%	\$474
CA 48x120 (1 piece)	\$10,341	\$11,376	\$11,893	15%	\$474
CA 48x144 (1 piece)	\$11,534	\$12,687	\$13,264	15%	\$474
CA 60x144 (1 piece)	\$13,325	\$14,658	\$15,324	15%	\$474
CA 60x192 (2 pieces)	\$17,584	\$19,342	\$20,222	15%	\$474
CA 60x240 (2 pieces)	\$20,568	\$22,625	\$23,653	15%	\$474
BOAT (BOT)					
CA 36x48x96	\$6,442	\$7,086	\$7,408	15%	\$474

VOLUMA CONFERENCE TABLES - (VENE

ARCH BASE - LAMINATE



		Edge Choice: Wood (Red Oak & Maple)			Wood Upgrade	Option
		 V-12	 V-23	 V-19	Upgrade: Walnut / Mahogany / Cherry	SPECIAL HEIGHT
		 V-18	 V-17	ADD		
		 V-16	 V-32			
CA	42x54x120 (1 piece)	\$9,244	\$10,169	\$10,631	15%	\$474
CA	42x54x144 (1 piece)	\$9,715	\$10,687	\$11,173	15%	\$474
CA	48x60x192 (2 pieces)	\$13,174	\$14,492	\$15,151	15%	\$474
CA	48x60x240 (2 pieces)	\$14,210	\$15,631	\$16,341	15%	\$474
ARC BOAT (ARCBOT)						
CA	36x48x96	\$6,764	\$7,440	\$7,779	15%	\$474
CA	42x54x120 (1 piece)	\$9,706	\$10,677	\$11,162	15%	\$474
CA	42x54x144 (1 piece)	\$10,201	\$11,221	\$11,731	15%	\$474
CA	48x60x192 (2 pieces)	\$13,833	\$15,216	\$15,908	15%	\$474
CA	48x60x240 (2 pieces)	\$14,920	\$16,412	\$17,158	15%	\$474
OVAL (OVL)						
CA	42x96	\$8,203	\$9,024	\$9,434	15%	\$474
CA	48x96	\$8,203	\$9,024	\$9,434	15%	\$474
CA	48x120 (1 piece)	\$9,973	\$10,970	\$11,469	15%	\$474
CA	48x144 (1 piece)	\$12,740	\$14,014	\$14,651	15%	\$474
CA	60x120 (1 piece)	\$11,831	\$13,014	\$13,605	15%	\$474
CA	60x144 (1 piece)	\$14,963	\$16,460	\$17,208	15%	\$474

VOLUMA CONFERENCE TABLES - (LAMINATE - PVC & WOOD ED

ARCH BASE - VENEER

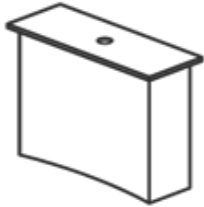

	Edge Choice: PVC & T-Mold				Edge Choice: Wood (Red Oak & Maple)			Wood Upgrade	Laminate Upgrades		Option	Light Weight
	T-15	L-21	P-14	PK-2	W-12	W-23	W-19	Upgrade: Walnut / Mahogany / Cherry	Laminate Upgrade I	Laminate Upgrade II	SPECIAL HEIGHT	Light Weight (PVC only - 1" top)
	P-10 (self)	P-12		PK-4	W-18	W-17	ADD		ADD	ADD	ADD	
	L-15			L-23	W-16	W-32						
RECTANGLE (REC)												
CAV 42x96	\$6,199		\$6,509	\$6,819	\$11,623	\$13,947	\$15,497	15%	\$465	\$1,240	\$474	\$1,085
CAV 48x96	\$6,313		\$6,628	\$6,944	\$11,836	\$14,203	\$15,781	15%	\$473	\$1,263	\$474	\$1,105
CAV 48x120 (1 piece)	\$9,132		\$9,588	\$10,045	\$17,122	\$20,547	\$22,830	15%	\$685	\$1,826	\$474	\$1,598
CAV 48x144 (1 piece)	\$9,375		\$9,843	\$10,312	\$17,577	\$21,093	\$23,436	15%	\$703	\$1,875	\$474	\$1,641
CAV 48x168 (2 pieces)	\$12,194		\$12,804	\$13,413	\$22,864	\$27,436	\$30,485	15%	\$915	\$2,439	\$474	\$2,134
CAV 48x192 (2 pieces)	\$12,437		\$13,058	\$13,680	\$23,319	\$27,982	\$31,091	15%	\$933	\$2,487	\$474	\$2,176
CAV 60x120 (1 piece)	\$9,412		\$9,883	\$10,354	\$17,648	\$21,178	\$23,531	15%	\$706	\$1,882	\$474	\$1,647
CAV 60x144 (1 piece)	\$9,708		\$10,193	\$10,679	\$18,203	\$21,843	\$24,270	15%	\$728	\$1,942	\$474	\$1,699
CAV 60x168 (2 pieces)	\$12,580		\$13,209	\$13,838	\$23,588	\$28,306	\$31,451	15%	\$944	\$2,516	\$474	\$2,202
CAV 60x192 (2 pieces)	\$12,876		\$13,520	\$14,164	\$24,143	\$28,971	\$32,190	15%	\$966	\$2,575	\$474	\$2,253
CAV 60x240 (2 pieces)	\$13,468		\$14,141	\$14,814	\$25,252	\$30,302	\$33,669	15%	\$1,010	\$2,694	\$474	\$2,357
ARC RECTANGLE (ARC REC)												
CAV 42x96	\$6,509		\$6,834	\$7,160	\$12,204	\$14,645	\$16,272	15%	\$488	\$1,302	\$474	\$1,139
CAV 48x96	\$6,628		\$6,960	\$7,291	\$12,428	\$14,913	\$16,570	15%	\$497	\$1,326	\$474	\$1,160
CAV 48x120 (1 piece)	\$9,588		\$10,068	\$10,547	\$17,978	\$21,574	\$23,971	15%	\$719	\$1,918	\$474	\$1,678
CAV 48x144 (1 piece)	\$9,843		\$10,335	\$10,828	\$18,456	\$22,147	\$24,608	15%	\$738	\$1,969	\$474	\$1,723
CAV 48x168 (2 pieces)	\$12,804		\$13,444	\$14,084	\$24,007	\$28,808	\$32,009	15%	\$960	\$2,561	\$474	\$2,241
CAV 48x192 (2 pieces)	\$13,058		\$13,711	\$14,364	\$24,485	\$29,381	\$32,646	15%	\$979	\$2,612	\$474	\$2,285
CAV 60x120 (1 piece)	\$9,883		\$10,377	\$10,871	\$18,530	\$22,237	\$24,707	15%	\$741	\$1,977	\$474	\$1,730
CAV 60x144 (1 piece)	\$10,193		\$10,703	\$11,213	\$19,113	\$22,935	\$25,484	15%	\$765	\$2,039	\$474	\$1,784
CAV 60x168 (2 pieces)	\$13,209		\$13,870	\$14,530	\$24,768	\$29,721	\$33,024	15%	\$991	\$2,642	\$474	\$2,312
CAV 60x192 (2 pieces)	\$13,520		\$14,196	\$14,872	\$25,350	\$30,420	\$33,800	15%	\$1,014	\$2,704	\$474	\$2,366
CAV 60x240 (2 pieces)	\$14,141		\$14,848	\$15,555	\$26,514	\$31,817	\$35,353	15%	\$1,061	\$2,828	\$474	\$2,475
RACETRACK (RAC)												
CAV 42x84	\$6,176		\$6,484	\$6,793	\$11,579	\$13,895	\$15,439	15%	\$463	\$1,235	\$474	\$1,081
CAV 42x96	\$6,284		\$6,598	\$6,912	\$11,782	\$14,138	\$15,709	15%	\$471	\$1,257	\$474	\$1,100
CAV 48x96	\$6,397		\$6,717	\$7,037	\$11,995	\$14,394	\$15,994	15%	\$480	\$1,279	\$474	\$1,120
CAV 48x120 (1 piece)	\$9,217		\$9,678	\$10,138	\$17,281	\$20,738	\$23,042	15%	\$691	\$1,843	\$474	\$1,613
CAV 48x144 (1 piece)	\$9,459		\$9,932	\$10,405	\$17,737	\$21,284	\$23,649	15%	\$709	\$1,892	\$474	\$1,655
CAV 60x144 (1 piece)	\$9,793		\$10,283	\$10,772	\$18,362	\$22,034	\$24,482	15%	\$734	\$1,959	\$474	\$1,714
CAV 60x192 (2 pieces)	\$12,961		\$13,609	\$14,257	\$24,302	\$29,162	\$32,403	15%	\$972	\$2,592	\$474	\$2,268
CAV 60x240 (2 pieces)	\$13,553		\$14,230	\$14,908	\$25,411	\$30,493	\$33,881	15%	\$1,016	\$2,711	\$474	\$2,372
BOAT (BOT)												
CAV 36x48x96	\$6,397		\$6,717	\$7,037	\$11,995	\$14,394	\$15,994	15%	\$480	\$1,279	\$474	\$1,120

VOLUMA CONFERENCE TABLES - (LAMINATE - PVC & WOOD ED

ARCH BASE - VENEER

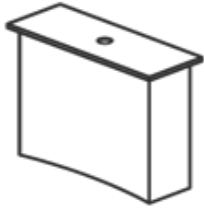

		Edge Choice: PVC & T-Mold				Edge Choice: Wood (Red Oak & Maple)			Wood Upgrade	Laminate Upgrades	Option	Light Weight	
		T-15	L-21	P-14	PK-2	W-12	W-23	W-19	Upgrade: Walnut / Mahogany / Cherry	Laminate Upgrade I	Laminate Upgrade II	SPECIAL HEIGHT	Light Weight (PVC only - 1" top)
		P-10 (self)	P-12		PK-4	W-18	W-17	ADD					
		L-15			L-23	W-16	W-32						
CAV	42x54x120 (1 piece)	\$9,357		\$9,825	\$10,293	\$17,544	\$21,053	\$23,392	15%	\$702	\$1,871	\$474	\$1,637
CAV	42x54x144 (1 piece)	\$9,626		\$10,108	\$10,589	\$18,049	\$21,659	\$24,066	15%	\$722	\$1,925	\$474	\$1,685
CAV	48x60x192 (2 pieces)	\$12,961		\$13,609	\$14,257	\$24,302	\$29,162	\$32,403	15%	\$972	\$2,592	\$474	\$2,268
CAV	48x60x240 (2 pieces)	\$13,553		\$14,230	\$14,908	\$25,411	\$30,493	\$33,881	15%	\$1,016	\$2,711	\$474	\$2,372
ARC BOAT (ARCBOT)													
CAV	36x48x96	\$6,717		\$7,053	\$7,389	\$12,595	\$15,114	\$16,793	15%	\$504	\$1,343	\$474	\$1,176
CAV	42x54x120 (1 piece)	\$9,825		\$10,316	\$10,807	\$18,422	\$22,106	\$24,562	15%	\$737	\$1,965	\$474	\$1,719
CAV	42x54x144 (1 piece)	\$10,108		\$10,613	\$11,118	\$18,952	\$22,742	\$25,269	15%	\$758	\$2,022	\$474	\$1,769
CAV	48x60x192 (2 pieces)	\$13,609		\$14,290	\$14,970	\$25,517	\$30,621	\$34,023	15%	\$1,021	\$2,722	\$474	\$2,382
CAV	48x60x240 (2 pieces)	\$14,230		\$14,942	\$15,653	\$26,682	\$32,018	\$35,575	15%	\$1,067	\$2,846	\$474	\$2,490
OVAL (OVL)													
CAV	42x96	\$6,284		\$6,598	\$6,912	\$11,782	\$14,138	\$15,709	15%	\$471	\$1,257	\$474	\$1,100
CAV	48x96	\$6,397		\$6,717	\$7,037	\$11,995	\$14,394	\$15,994	15%	\$480	\$1,279	\$474	\$1,120
CAV	48x120 (1 piece)	\$6,640		\$6,972	\$7,304	\$12,450	\$14,940	\$16,600	15%	\$498	\$1,328	\$474	\$1,162
CAV	48x144 (1 piece)	\$9,459		\$9,932	\$10,405	\$17,737	\$21,284	\$23,649	15%	\$709	\$1,892	\$474	\$1,655
CAV	60x120 (1 piece)	\$6,921		\$7,267	\$7,613	\$12,976	\$15,571	\$17,302	15%	\$519	\$1,384	\$474	\$1,211
CAV	60x144 (1 piece)	\$9,793		\$10,283	\$10,772	\$18,362	\$22,034	\$24,482	15%	\$734	\$1,959	\$474	\$1,714

VOLUMA CONFERENCE TABLES - (VENEER)

ARCH BASE - VENEER

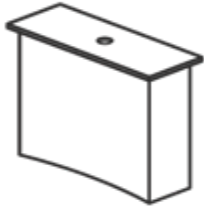

	Edge Choice: Wood (Red Oak & Maple)			Wood Upgrade	Option
	V-12	V-23 V-18 V-16	V-19 V-17 V-32	Upgrade: Walnut / Mahogany / Cherry	SPECIAL HEIGHT
				ADD	ADD
RECTANGLE (REC)					
CAV 42x96	\$10,848	\$11,933	\$12,475	15%	\$474
CAV 48x96	\$11,047	\$12,152	\$12,704	15%	\$474
CAV 48x120 (1 piece)	\$14,097	\$15,506	\$16,211	15%	\$474
CAV 48x144 (1 piece)	\$15,289	\$16,818	\$17,582	15%	\$474
CAV 48x168 (2 pieces)	\$19,193	\$21,112	\$22,072	15%	\$474
CAV 48x192 (2 pieces)	\$20,385	\$22,423	\$23,443	15%	\$474
CAV 60x120 (1 piece)	\$15,589	\$17,147	\$17,927	15%	\$474
CAV 60x144 (1 piece)	\$17,080	\$18,788	\$19,642	15%	\$474
CAV 60x168 (2 pieces)	\$21,277	\$23,405	\$24,469	15%	\$474
CAV 60x192 (2 pieces)	\$22,769	\$25,046	\$26,184	15%	\$474
CAV 60x240 (2 pieces)	\$25,753	\$28,328	\$29,616	15%	\$474
ARC RECTANGLE (ARC REC)					
CAV 42x96	\$11,390	\$12,529	\$13,099	15%	\$474
CAV 48x96	\$11,599	\$12,759	\$13,339	15%	\$474
CAV 48x120 (1 piece)	\$14,802	\$16,282	\$17,022	15%	\$474
CAV 48x144 (1 piece)	\$16,053	\$17,658	\$18,461	15%	\$474
CAV 48x168 (2 pieces)	\$20,153	\$22,168	\$23,175	15%	\$474
CAV 48x192 (2 pieces)	\$21,404	\$23,545	\$24,615	15%	\$474
CAV 60x120 (1 piece)	\$16,368	\$18,005	\$18,823	15%	\$474
CAV 60x144 (1 piece)	\$17,934	\$19,728	\$20,625	15%	\$474
CAV 60x168 (2 pieces)	\$22,341	\$24,575	\$25,692	15%	\$474
CAV 60x192 (2 pieces)	\$23,907	\$26,298	\$27,494	15%	\$474
CAV 60x240 (2 pieces)	\$27,040	\$29,744	\$31,096	15%	\$474
RACETRACK (RAC)					
CAV 42x84	\$10,807	\$11,888	\$12,428	15%	\$474
CAV 42x96	\$10,997	\$12,096	\$12,646	15%	\$474
CAV 48x96	\$10,434	\$11,477	\$11,999	15%	\$474
CAV 48x120 (1 piece)	\$14,631	\$16,094	\$16,825	15%	\$474
CAV 48x144 (1 piece)	\$15,823	\$17,405	\$18,196	15%	\$474
CAV 60x144 (1 piece)	\$17,614	\$19,376	\$20,256	15%	\$474
CAV 60x192 (2 pieces)	\$23,303	\$25,633	\$26,798	15%	\$474
CAV 60x240 (2 pieces)	\$26,287	\$28,915	\$30,230	15%	\$474
BOAT (BOT)					
CAV 36x48x96	\$11,196	\$12,315	\$12,875	15%	\$474

VOLUMA CONFERENCE TABLES - (VENEER)

ARCH BASE - VENEER

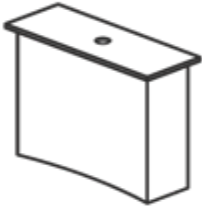

	Edge Choice: Wood (Red Oak & Maple)			Wood Upgrade	Option
	V-12	V-23	V-19	Upgrade: Walnut / Mahogany / Cherry	SPECIAL HEIGHT
		V-18	V-17	ADD	ADD
		V-16	V-32		
CAV 42x54x120 (1 piece)	\$16,375	\$18,012	\$18,831	15%	\$474
CAV 42x54x144 (1 piece)	\$16,846	\$18,530	\$19,373	15%	\$474
CAV 48x60x192 (2 pieces)	\$22,682	\$24,950	\$26,084	15%	\$474
CAV 48x60x240 (2 pieces)	\$23,717	\$26,089	\$27,275	15%	\$474
ARC BOAT (ARCBOT)					
CAV 36x48x96	\$11,755	\$12,931	\$13,519	15%	\$474
CAV 42x54x120 (1 piece)	\$17,193	\$18,913	\$19,773	15%	\$474
CAV 42x54x144 (1 piece)	\$17,688	\$19,457	\$20,341	15%	\$474
CAV 48x60x192 (2 pieces)	\$23,816	\$26,198	\$27,388	15%	\$474
CAV 48x60x240 (2 pieces)	\$24,903	\$27,393	\$28,638	15%	\$474
OVAL (OVL)					
CAV 42x96	\$11,063	\$12,169	\$12,722	15%	\$474
CAV 48x96	\$11,063	\$12,169	\$12,722	15%	\$474
CAV 48x120 (1 piece)	\$12,832	\$14,116	\$14,757	15%	\$474
CAV 48x144 (1 piece)	\$17,029	\$18,732	\$19,584	15%	\$474
CAV 60x120 (1 piece)	\$14,690	\$16,159	\$16,893	15%	\$474
CAV 60x144 (1 piece)	\$19,252	\$21,178	\$22,140	15%	\$474

iQ CONFERENCE TABLES - (LAMINATE - PVC & WOOD EDGE)

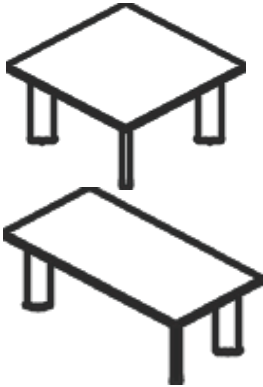

SQUARE (SQR)

IQC 42x42	\$2,047	\$2,150	\$2,252	\$3,839	\$4,607	\$5,118	15%	\$154	\$409	\$54	\$217
IQC 48x48	\$2,162	\$2,270	\$2,378	\$4,054	\$4,865	\$5,405	15%	\$162	\$432	\$54	\$217
IQC 60x60	\$2,652	\$2,785	\$2,918	\$4,973	\$5,968	\$6,631	15%	\$199	\$530	\$54	\$217







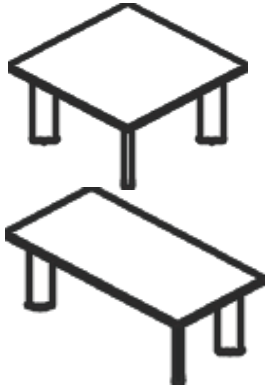

RECTANGLE (REC)

IQC 42x72	\$2,539	\$2,666	\$2,793	\$4,760	\$5,712	\$6,347	15%	\$190	\$508	\$54	\$217
IQC 42x84	\$3,170	\$3,328	\$3,487	\$5,943	\$7,132	\$7,925	15%	\$238	\$634	\$81	\$325
IQC 42x96	\$3,278	\$3,442	\$3,606	\$6,146	\$7,375	\$8,195	15%	\$246	\$656	\$81	\$325
IQC 42x120 (1 piece)	\$3,494	\$3,669	\$3,844	\$6,551	\$7,862	\$8,735	15%	\$262	\$699	\$81	\$325
IQC 42x144 (1 piece)	\$4,153	\$4,360	\$4,568	\$7,786	\$9,343	\$10,381	15%	\$311	\$831	\$81	\$325
IQC 48x96	\$3,392	\$3,561	\$3,731	\$6,359	\$7,631	\$8,479	15%	\$254	\$678	\$81	\$325
IQC 48x120 (1 piece)	\$3,634	\$3,816	\$3,998	\$6,814	\$8,177	\$9,086	15%	\$273	\$727	\$81	\$325
IQC 48x144 (1 piece)	\$4,319	\$4,535	\$4,751	\$8,099	\$9,718	\$10,798	15%	\$324	\$864	\$81	\$325
IQC 48x168 (2 pieces)	\$5,085	\$5,339	\$5,593	\$9,534	\$11,441	\$12,712	15%	\$381	\$1,017	\$108	\$433
IQC 48x192 (2 pieces)	\$5,851	\$6,143	\$6,436	\$10,970	\$13,164	\$14,627	15%	\$439	\$1,170	\$135	\$542
IQC 48x216 (2 pieces)	\$6,093	\$6,398	\$6,703	\$11,425	\$13,710	\$15,233	15%	\$457	\$1,219	\$135	\$542
IQC 48x240 (2 pieces)	\$7,301	\$7,666	\$8,031	\$13,690	\$16,428	\$18,253	15%	\$548	\$1,460	\$163	\$1,083
IQC 60x144 (1 piece)	\$4,653	\$4,885	\$5,118	\$8,724	\$10,469	\$11,632	15%	\$349	\$931	\$81	\$325
IQC 60x168 (2 pieces)	\$5,471	\$5,745	\$6,019	\$10,259	\$12,311	\$13,679	15%	\$410	\$1,094	\$108	\$433
IQC 60x192 (2 pieces)	\$6,290	\$6,605	\$6,919	\$11,794	\$14,153	\$15,726	15%	\$472	\$1,258	\$135	\$542
IQC 60x216 (2 pieces)	\$6,586	\$6,915	\$7,245	\$12,349	\$14,818	\$16,465	15%	\$494	\$1,317	\$135	\$542
IQC 60x240 (2 pieces)	\$7,847	\$8,239	\$8,632	\$14,713	\$17,656	\$19,617	15%	\$589	\$1,569	\$163	\$1,083

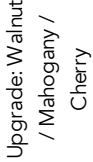
Edge Choice: PVC & T-Mold				Edge Choice: Wood (Red Oak & Maple)			Wood Upgrade	Laminate Upgrades		E1	E2
T-15	L-21	P-14	PK-2	W-12	W-23	W-19	Upgrade: Walnut / Mahogany / Cherry	Laminate Upgrade I	Laminate Upgrade II	Removable Cover	Wire Management
P-10 (self)	P-12		PK-4		W-18	W-17		ADD	ADD	ADD	ADD
L-15			L-23		W-16	W-32					
IQC 42x42	\$2,047	\$2,150	\$2,252	\$3,839	\$4,607	\$5,118	15%	\$154	\$409	\$54	\$217
IQC 48x48	\$2,162	\$2,270	\$2,378	\$4,054	\$4,865	\$5,405	15%	\$162	\$432	\$54	\$217
IQC 60x60	\$2,652	\$2,785	\$2,918	\$4,973	\$5,968	\$6,631	15%	\$199	\$530	\$54	\$217
IQC 42x72	\$2,539	\$2,666	\$2,793	\$4,760	\$5,712	\$6,347	15%	\$190	\$508	\$54	\$217
IQC 42x84	\$3,170	\$3,328	\$3,487	\$5,943	\$7,132	\$7,925	15%	\$238	\$634	\$81	\$325
IQC 42x96	\$3,278	\$3,442	\$3,606	\$6,146	\$7,375	\$8,195	15%	\$246	\$656	\$81	\$325
IQC 42x120 (1 piece)	\$3,494	\$3,669	\$3,844	\$6,551	\$7,862	\$8,735	15%	\$262	\$699	\$81	\$325
IQC 42x144 (1 piece)	\$4,153	\$4,360	\$4,568	\$7,786	\$9,343	\$10,381	15%	\$311	\$831	\$81	\$325
IQC 48x96	\$3,392	\$3,561	\$3,731	\$6,359	\$7,631	\$8,479	15%	\$254	\$678	\$81	\$325
IQC 48x120 (1 piece)	\$3,634	\$3,816	\$3,998	\$6,814	\$8,177	\$9,086	15%	\$273	\$727	\$81	\$325
IQC 48x144 (1 piece)	\$4,319	\$4,535	\$4,751	\$8,099	\$9,718	\$10,798	15%	\$324	\$864	\$81	\$325
IQC 48x168 (2 pieces)	\$5,085	\$5,339	\$5,593	\$9,534	\$11,441	\$12,712	15%	\$381	\$1,017	\$108	\$433
IQC 48x192 (2 pieces)	\$5,851	\$6,143	\$6,436	\$10,970	\$13,164	\$14,627	15%	\$439	\$1,170	\$135	\$542
IQC 48x216 (2 pieces)	\$6,093	\$6,398	\$6,703	\$11,425	\$13,710	\$15,233	15%	\$457	\$1,219	\$135	\$542
IQC 48x240 (2 pieces)	\$7,301	\$7,666	\$8,031	\$13,690	\$16,428	\$18,253	15%	\$548	\$1,460	\$163	\$1,083
IQC 60x144 (1 piece)	\$4,653	\$4,885	\$5,118	\$8,724	\$10,469	\$11,632	15%	\$349	\$931	\$81	\$325
IQC 60x168 (2 pieces)	\$5,471	\$5,745	\$6,019	\$10,259	\$12,311	\$13,679	15%	\$410	\$1,094	\$108	\$433
IQC 60x192 (2 pieces)	\$6,290	\$6,605	\$6,919	\$11,794	\$14,153	\$15,726	15%	\$472	\$1,258	\$135	\$542
IQC 60x216 (2 pieces)	\$6,586	\$6,915	\$7,245	\$12,349	\$14,818	\$16,465	15%	\$494	\$1,317	\$135	\$542
IQC 60x240 (2 pieces)	\$7,847	\$8,239	\$8,632	\$14,713	\$17,656	\$19,617	15%	\$589	\$1,569	\$163	\$1,083

iQ CONFERENCE TABLES - (VENEER)



	Edge Choice: Wood (Red Oak & Maple)			Wood Upgrade	E1	E2
	 V-12	 V-23	 V-19	 Upgrade: Walnut / Mahogany / Cherry		
	 V-18	 V-17	ADD		ADD	ADD
	 V-16	 V-32			Removable Cover	Wire Management
SQUARE (SQR)						
IQC 42x42	\$4,261	\$4,687	\$4,900	15%	\$54	\$217
IQC 48x48	\$4,946	\$5,440	\$5,687	15%	\$54	\$217
IQC 60x60	\$5,295	\$5,824	\$6,089	15%	\$54	\$217
RECTANGLE (REC)						
IQC 42x72	\$5,077	\$5,585	\$5,839	15%	\$54	\$217
IQC 42x84	\$6,340	\$6,974	\$7,291	15%	\$81	\$325
IQC 42x96	\$6,556	\$7,211	\$7,539	15%	\$81	\$325
IQC 42x120 (1 piece)	\$6,988	\$7,687	\$8,036	15%	\$81	\$325
IQC 42x144 (1 piece)	\$8,305	\$9,136	\$9,551	15%	\$81	\$325
IQC 48x96	\$6,825	\$7,508	\$7,849	15%	\$81	\$325
IQC 48x120 (1 piece)	\$8,310	\$9,141	\$9,556	15%	\$81	\$325
IQC 48x144 (1 piece)	\$9,967	\$10,964	\$11,462	15%	\$81	\$325
IQC 48x168 (2 pieces)	\$11,710	\$12,881	\$13,466	15%	\$108	\$433
IQC 48x192 (2 pieces)	\$13,452	\$14,798	\$15,470	15%	\$135	\$542
IQC 48x216 (2 pieces)	\$16,852	\$18,538	\$19,380	15%	\$135	\$542
IQC 48x240 (2 pieces)	\$16,852	\$18,538	\$19,380	15%	\$163	\$1,083
IQC 60x144 (1 piece)	\$11,759	\$12,935	\$13,523	15%	\$81	\$325
IQC 60x168 (2 pieces)	\$13,794	\$15,173	\$15,863	15%	\$108	\$433
IQC 60x192 (2 pieces)	\$15,836	\$17,420	\$18,212	15%	\$135	\$542
IQC 60x216 (2 pieces)	\$19,836	\$21,820	\$22,812	15%	\$135	\$542
IQC 60x240 (2 pieces)	\$19,836	\$21,820	\$22,812	15%	\$163	\$1,083

WEST END



WEST END

With its rugged industrial look, the WEST END series table adds a new dimension to the parsons or community style table. Available in 30", 36" or 42" heights and lengths up to 120" as standard you have plenty of size options to choose from. Or if our standard dimensions don't quite work, we will make one to your specifications. Standard top options for this series are laminate or butcherblock, but we can also make your top in other materials like solid surface, veneer, stone, or other materials.

Table Pedestal Specifications:

Finishes: Available in over 40+ standard powder coat finishes

Table Specifications:

Construction: Each end base is made of two 2" x 2" steel uprights joined together by a 1.5"x1.5" joiner bar all welded together and comprised of 14 gauge cold rolled tube. At the top of the base is a 4"x 4" x 1/8" thick top plate to attach the base to your top.

For additional structural support all tables include a cross bar that attaches the lower portion of each base to one another.







Overhang of tops: For tops up to 72" in length, there is a minimal overhang of approximately 6 inches from the base upright.

On an 84" top there is a 12" overhang, and on 96" tops there is a 18" overhang. 120" tops have 3 legs.

Table stiffeners are supplied where needed based on the length of the top and are included in the list price of the table.

Glides and Casters: All tables are equipped with leveling glides as standard, locking casters are available as an option.

WEST END TABLES - (LAMINATE - PVC EDGE)	WEST END TABLES - (1-1/2" BUTCHERBLOCK)
---	---

	Edge Choices: PVC & T-Mold			Laminate Upgrades		OPTIONS			Standard	Wood Upgrade	OPTIONS		
	 T-15	 L-21	 P-14	Laminate Upgrade I	Laminate Upgrade II	36" Height	42" Height	CASTERS	Red Oak	Maple	36" Height	42" Height	CASTERS
	 P-10 (self)	 P-12		ADD	ADD	ADD	ADD	ADD		ADD	ADD	ADD	ADD
	 L-15												
RECTANGLE (REC)													
WE2 24x60	\$2,470	\$2,593	\$185	\$494	\$450	\$450	\$240	\$3,027	15%	\$450	\$450	\$240	
WE2 24x72	\$2,764	\$2,902	\$207	\$553	\$450	\$450	\$240	\$3,206	15%	\$450	\$450	\$240	
WE2 24x84	\$2,835	\$2,977	\$213	\$567	\$450	\$450	\$240	\$3,659	15%	\$450	\$450	\$240	
WE2 24x96	\$2,909	\$3,054	\$218	\$582	\$450	\$450	\$240	\$3,905	15%	\$450	\$450	\$240	
WE2 30x60	\$2,678	\$2,811	\$201	\$536	\$450	\$450	\$240	\$3,346	15%	\$450	\$450	\$240	
WE2 30x72	\$2,910	\$3,055	\$218	\$582	\$450	\$450	\$240	\$3,557	15%	\$450	\$450	\$240	
WE2 30x84	\$3,071	\$3,225	\$230	\$614	\$450	\$450	\$240	\$4,111	15%	\$450	\$450	\$240	
WE2 30x96	\$3,157	\$3,315	\$237	\$631	\$450	\$450	\$240	\$4,403	15%	\$450	\$450	\$240	
WE2 36x60	\$2,919	\$3,065	\$219	\$584	\$450	\$450	\$240	\$3,716	15%	\$450	\$450	\$240	
WE2 36x72	\$3,241	\$3,403	\$243	\$648	\$450	\$450	\$240	\$3,960	15%	\$450	\$450	\$240	
WE2 36x84	\$3,341	\$3,508	\$251	\$668	\$450	\$450	\$240						
WE2 36x96	\$3,442	\$3,614	\$258	\$688	\$450	\$450	\$240						
WE2 42x60	\$3,334	\$3,500	\$250	\$667	\$450	\$450	\$240						
WE2 42x72	\$3,671	\$3,854	\$275	\$734	\$450	\$450	\$240						
WE2 42x84	\$3,784	\$3,973	\$284	\$757	\$450	\$450	\$240						
WE2 42x96	\$3,898	\$4,092	\$292	\$780	\$450	\$450	\$240						
WE2 42 x 120 (3 bases)	\$5,002	\$5,252	\$375	\$1,000	\$660	\$660	\$360						
WE2 48x72	\$3,959	\$4,156	\$297	\$792	\$450	\$450	\$240						
WE2 48x84	\$4,087	\$4,291	\$306	\$817	\$450	\$450	\$240						
WE2 48x96	\$4,215	\$4,425	\$316	\$843	\$450	\$450	\$240						
WE2 48 x 120 (3 bases)	\$5,444	\$5,716	\$408	\$1,089	\$660	\$660	\$360						
WE2 60x96	\$4,561	\$4,789	\$342	\$912	\$450	\$450	\$240						
WE2 60 x 120 (3 bases)	\$5,902	\$6,197	\$443	\$1,180	\$660	\$660	\$360						

BASES ONLY



BASES ONLY

		OPTIONS													
	BASE	NESTING (Per 2 EB) - Under 84"	NESTING (Per 2 EB) - 84" & 96"	FOLDING	FLIP TOP	POWDERCOAT UPGRADE	UPGRADE FINISH (MIN. 10	CHROME	DELUXE CASTERS (BLK)	EQUALIZER	GLIDES	ANGLE BASE (Per Table)	OFFSET BASE (Per Table)	ADJ. HEIGHT PIN (Per Table)	SPECIAL HEIGHT (Per
		ADD	ADD	ADD	ADD	ADD	ADD	ADD	ADD	ADD	ADD	ADD	ADD	ADD	ADD
SENSE		LIMITED BASE FINISH OPTIONS - TEXTURED ONLY													
SN1-16EB	16" End	\$124	\$389	\$389	\$212	N/A	N/A	\$68	N/A	\$81	\$30	N/A	N/A	\$711	\$80
SN1-20EB	20" End	\$127	\$389	\$389	\$212	N/A	N/A	\$68	N/A	\$81	\$30	N/A	N/A	\$711	\$80
SN1-26EB	26" End	\$171	\$389	\$389	\$212	N/A	N/A	\$68	N/A	\$81	\$30	N/A	N/A	\$711	\$80
SNX-22	22" X	\$256	N/A	N/A	N/A	\$112	N/A	\$102	N/A	\$163	\$61	N/A	N/A	N/A	\$80
SNX-26	26" X	\$261	N/A	N/A	N/A	\$112	N/A	\$102	N/A	\$163	\$61	N/A	N/A	N/A	\$80
SNX-32	32" X	\$264	N/A	N/A	N/A	\$112	N/A	\$102	N/A	\$163	\$61	N/A	N/A	N/A	\$80
SNX-38	38" X	\$328	N/A	N/A	N/A	\$112	N/A	\$102	N/A	\$163	\$61	N/A	N/A	N/A	\$80
STARFIRE		LIMITED BASE FINISH OPTIONS - TEXTURED ONLY													
ST1-22EB	22" End	\$225	\$389	\$389	N/A	N/A	N/A	\$142	N/A	\$81	\$30	N/A	N/A	\$711	\$80
ST1-26EB	26" End	\$236	\$389	\$389	N/A	N/A	N/A	\$142	N/A	\$81	\$30	N/A	N/A	\$711	\$80
STX-22	22" X	\$300	N/A	N/A	N/A	\$112	N/A	\$284	N/A	\$163	\$61	N/A	N/A	N/A	\$80
STX-26	26" X	\$319	N/A	N/A	N/A	\$112	N/A	\$284	N/A	\$163	\$61	N/A	N/A	N/A	\$80
STX-32	32" X	\$404	N/A	N/A	N/A	\$112	N/A	\$284	N/A	\$163	\$61	N/A	N/A	N/A	\$80
STX-42	42" X	\$567	N/A	N/A	N/A	\$112	N/A	\$284	N/A	\$163	\$61	N/A	N/A	N/A	\$80
STX-2431	24"x31" X	\$508	N/A	N/A	N/A	\$112	N/A	\$284	N/A	\$163	\$61	N/A	N/A	N/A	\$80
VOYAGER		LIMITED BASE FINISH OPTIONS - TEXTURED ONLY													
VS1-16EB	16" 1 Col.	\$249	\$389	\$389	\$212	N/A	\$134	N/A	\$169	\$81	\$30	\$34	\$134	\$711	\$80
VS1-20EB	20" 1 Col.	\$254	\$389	\$389	\$212	N/A	\$134	N/A	\$169	\$81	\$30	\$34	\$134	\$711	\$80
VS1-26EB	26" 1 Col.	\$262	\$389	\$389	\$212	N/A	\$134	N/A	\$169	\$81	\$30	\$34	\$134	\$711	\$80
VS2-16EB	16" 2 Col.	\$324	\$389	\$389	\$212	N/A	\$134	N/A	\$271	\$81	\$30	\$34	\$134	\$711	\$80
VS2-20EB	20" 2 Col.	\$325	\$389	\$389	\$212	N/A	\$134	N/A	\$271	\$81	\$30	\$34	\$134	\$711	\$80
VS2-26EB	26" 2 Col.	\$328	\$389	\$389	\$212	N/A	\$134	N/A	\$271	\$81	\$30	\$34	\$134	\$711	\$80
VS2-32EB	32" 2 Col.	\$452	\$389	\$389	\$212	N/A	\$134	N/A	\$271	\$81	\$30	\$34	\$134	\$711	\$80
VS2-38EB	38" 2 Col.	\$459	\$389	\$389	\$212	N/A	\$134	N/A	\$271	\$81	\$30	\$34	\$134	\$711	\$80
VS2-42EB	42" 2 Col.	\$462	\$389	\$389	\$212	N/A	\$134	N/A	\$271	\$81	\$30	\$34	\$134	\$711	\$80
VSX-22	22" X	\$416	N/A	N/A	N/A	\$112	\$134	N/A	\$271	\$163	\$61	N/A	N/A	N/A	\$80
VSX-26	26" X	\$423	N/A	N/A	N/A	\$112	\$134	N/A	\$271	\$163	\$61	N/A	N/A	N/A	\$80
VSX-32	32" X	\$427	N/A	N/A	N/A	\$112	\$134	N/A	\$271	\$163	\$61	N/A	N/A	N/A	\$80
VSX-38	38" X	\$518	N/A	N/A	N/A	\$112	\$134	N/A	\$271	\$163	\$61	N/A	N/A	N/A	\$80
VSX-38-5	38"-5 X	\$757	N/A	N/A	N/A	N/A	\$134	N/A	\$542	\$163	\$61	N/A	N/A	N/A	\$80
VSX-2226	22"x26" X	\$423	N/A	N/A	N/A	\$112	\$134	N/A	\$271	\$163	\$61	N/A	N/A	N/A	\$80
VSX-2638	26"x38" X	\$511	N/A	N/A	N/A	\$112	\$134	N/A	\$271	\$163	\$61	N/A	N/A	N/A	\$80
VSX-3238	32"x38" X	\$511	N/A	N/A	N/A	\$112	\$134	N/A	\$271	\$163	\$61	N/A	N/A	N/A	\$80

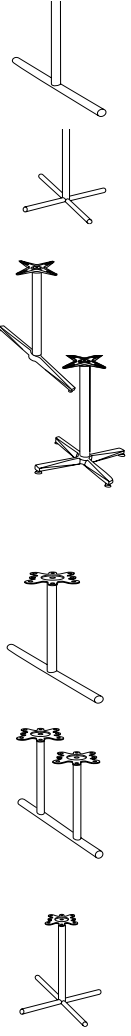

BASES ONLY

	BASE	OPTIONS												
		NESTING (Per 2 EB) - Under 84"	NESTING (Per 2 EB) - 84" & 96"	FOLDING	FLIP TOP	POWDERCOAT UPGRADE	UPGRADE FINISH (MIN. 10	CHROME	DELUXE CASTERS (BLK)	EQUALIZER GLIDES	ANGLE BASE (Per Table)	OFFSET BASE (Per Table)	ADJ. HEIGHT PIN (Per Table)	SPECIAL HEIGHT (Per
		ADD	ADD	ADD	ADD	ADD	ADD	ADD	ADD	ADD	ADD	ADD	ADD	ADD
VOYAGER PREMIUM SOLID STEEL														
VS1BAR-16EB 16" 1 Col.	\$447	\$389	\$389	N/A	N/A	\$134	N/A	\$169	\$81	\$30	\$34	\$134	\$711	\$80
VS1BAR-20EB 20" 1 Col.	\$477	\$389	\$389	N/A	N/A	\$134	N/A	\$169	\$81	\$30	\$34	\$134	\$711	\$80
VS1BAR-26EB 26" 1 Col.	\$515	\$389	\$389	N/A	N/A	\$134	N/A	\$169	\$81	\$30	\$34	\$134	\$711	\$80
VS1BAR-36EB 36" 1 Col.	\$574	\$389	\$389	N/A	N/A	\$134	N/A	\$169	\$81	\$30	\$34	\$134	\$711	\$80
VS2BAR-36EB 36" 2 Col.	\$722	\$389	\$389	N/A	N/A	\$134	N/A	\$271	\$81	\$30	\$34	\$134	\$711	\$80
VS2BAR-42EB 42" 2 Col.	\$767	\$389	\$389	N/A	N/A	\$134	N/A	\$271	\$81	\$30	\$34	\$134	\$711	\$80
VXBAR-20 20" X	\$952	N/A	N/A	N/A	\$112	\$134	N/A	\$271	\$163	\$61	N/A	N/A	N/A	\$80
VXBAR-26 26" X	\$1,058	N/A	N/A	N/A	\$112	\$134	N/A	\$271	\$163	\$61	N/A	N/A	N/A	\$80
VXBAR-30 30" X	\$1,204	N/A	N/A	N/A	\$112	\$134	N/A	\$271	\$163	\$61	N/A	N/A	N/A	\$80
VXBAR-36 36" X	\$1,274	N/A	N/A	N/A	\$112	\$134	N/A	\$271	\$163	\$61	N/A	N/A	N/A	\$80
VXBAR-36-5 36"-5 X	\$1,817	N/A	N/A	N/A	\$112	\$134	N/A	\$542	\$163	\$61	N/A	N/A	N/A	\$80
VXBAR-2026 20"x26" X	\$932	N/A	N/A	N/A	\$112	\$134	N/A	\$271	\$163	\$61	N/A	N/A	N/A	\$80
VXBAR-2630 26"x30" X	\$1,169	N/A	N/A	N/A	\$112	\$134	N/A	\$271	\$163	\$61	N/A	N/A	N/A	\$80
VXBAR-2636 26"x36" X	\$1,216	N/A	N/A	N/A	\$112	\$134	N/A	\$271	\$163	\$61	N/A	N/A	N/A	\$80
ANYWAY														
AN1-16EB 16" End	\$238	\$389	\$389	\$212	N/A	\$134	N/A	N/A	\$81	N/A	\$34	\$134	\$711	\$80
AN1-23EB 23" End	\$241	\$389	\$389	\$212	N/A	\$134	N/A	N/A	\$81	N/A	\$34	\$134	\$711	\$80
AN1-26EB 26" End	\$253	\$389	\$389	\$212	N/A	\$134	N/A	N/A	\$81	N/A	\$34	\$134	\$711	\$80
AN2-32EB 32" 2 Col.	\$507	N/A	N/A	N/A	N/A	\$134	N/A	N/A	\$81	N/A	N/A	N/A	N/A	\$80
AN2-39EB 39" 2 Col.	\$545	N/A	N/A	N/A	N/A	\$134	N/A	N/A	\$81	N/A	N/A	N/A	N/A	\$80
ANX-23 23" X	\$388	N/A	N/A	N/A	\$112	\$134	N/A	N/A	\$163	N/A	N/A	N/A	N/A	\$80
ANX-26 26" X	\$411	N/A	N/A	N/A	\$112	\$134	N/A	N/A	\$163	N/A	N/A	N/A	N/A	\$80
ANX-36-3" 36"X-3" Col.	\$556	N/A	N/A	N/A	\$112	\$134	N/A	N/A	\$163	N/A	N/A	N/A	N/A	\$80
ANX-36-4" 36"X 4" Col.	\$577	N/A	N/A	N/A	\$112	\$134	N/A	N/A	\$163	N/A	N/A	N/A	N/A	\$80
ANX2332	\$583	N/A	N/A	N/A	N/A	\$134	N/A	N/A	\$163	N/A	N/A	N/A	N/A	\$80
ANX2639	\$619	N/A	N/A	N/A	N/A	\$134	N/A	N/A	\$163	N/A	N/A	N/A	N/A	\$80
MOBI														
MB1-22EB 22" End	\$320	\$389	\$389	N/A	N/A	\$134	N/A	N/A	\$81	N/A	N/A	N/A	\$853	\$80
MBX-22 22" X	\$443	N/A	N/A	N/A	N/A	\$134	N/A	N/A	\$163	N/A	N/A	N/A	N/A	\$80
MBX-28 28" X	\$466	N/A	N/A	N/A	N/A	\$134	N/A	N/A	\$163	N/A	N/A	N/A	N/A	\$80
MBX-32 32" X	\$494	N/A	N/A	N/A	N/A	\$134	N/A	N/A	\$163	N/A	N/A	N/A	N/A	\$80
TELESTO														
TLS-20EB 20" End	\$305	\$389	\$389	N/A	N/A	\$134	N/A	N/A	\$81	N/A	N/A	N/A	N/A	\$80
TSL-26EB 26" End	\$320	\$389	\$389	N/A	N/A	\$134	N/A	N/A	\$81	N/A	N/A	N/A	N/A	\$80



BASES ONLY

		OPTIONS													
	BASE	NESTING (Per 2 EB) - Under 84"	NESTING (Per 2 EB) - 84" & 96"	FOLDING	FLIP TOP	POWDERCOAT UPGRADE	UPGRADE FINISH (MIN. 10	CHROME	DELUXE CASTERS (BLK)	EQUALIZER GLIDES	ANGLE BASE (Per Table)	OFFSET BASE (Per Table)	ADJ. HEIGHT PIN (Per Table)	SPECIAL HEIGHT (Per	
		ADD	ADD	ADD	ADD	ADD	ADD	ADD	ADD	ADD	ADD	ADD	ADD	ADD	
TITAN															
TS1-2	2" Flat Plug Leg	\$205	N/A	N/A	\$202	N/A	\$134	N/A	\$169	\$41	N/A	N/A	N/A	N/A	\$80
TS1-3	3" Flat Plug Leg	\$241	N/A	N/A	N/A	N/A	\$134	N/A	\$169	\$41	N/A	N/A	N/A	N/A	\$80
TS1-4	4" Flat Plug Leg	\$280	N/A	N/A	N/A	N/A	\$134	N/A	\$169	\$41	N/A	N/A	N/A	N/A	\$80
TS1-PMB	Perm. Mnt.	\$293	N/A	N/A	N/A	N/A	\$134	N/A	N/A	N/A	N/A	N/A	N/A	N/A	\$80
TS1-PMBE	Perm. Mnt. Elec	\$350	N/A	N/A	N/A	N/A	\$134	N/A	N/A	N/A	N/A	N/A	N/A	N/A	\$80
TS1-PMBCE	Concealed Elec.	\$650	N/A	N/A	N/A	N/A	\$134	N/A	N/A	N/A	N/A	N/A	N/A	N/A	\$80
iQ PLUS															
IQS-22EB	22" End	\$396	N/A	N/A	N/A	\$315	\$134	N/A	N/A	\$81	N/A	N/A	N/A	N/A	\$80
VORTEX															
VOX-18X	18" - no glides	\$564	N/A	N/A	N/A	\$112	\$134	N/A	\$271	N/A	N/A	N/A	N/A	N/A	\$80
VOX-24X	24" - no glides	\$737	N/A	N/A	N/A	\$112	\$134	N/A	\$271	N/A	N/A	N/A	N/A	N/A	\$80
VOX-30X	30" - with glides	\$1,086	N/A	N/A	N/A	\$112	\$134	N/A	\$271	N/A	N/A	N/A	N/A	N/A	\$80
DISCUS															
DSX-18X	18" Stl. Spin.	\$590	N/A	N/A	N/A	\$112	\$134	N/A	\$271	N/A	N/A	N/A	N/A	N/A	\$80
DSX-22X	22" Stl. Spin.	\$663	N/A	N/A	N/A	\$112	\$134	N/A	\$271	N/A	N/A	N/A	N/A	N/A	\$80
DSX-28X	28" Stl. Spin.	\$868	N/A	N/A	N/A	\$112	\$134	N/A	\$271	N/A	N/A	N/A	N/A	N/A	\$80
EXCALIBUR															
ES1-16	16" 1 Col.	\$400	\$389	\$389	N/A	N/A	\$134	N/A	\$169	\$81	\$30	CF	CF	\$711	\$80
ES1-20	20" 1 Col.	\$423	\$389	\$389	N/A	N/A	\$134	N/A	\$169	\$81	\$30	CF	CF	\$711	\$80
ES1-26	26" 1 Col.	\$459	\$389	\$389	N/A	N/A	\$134	N/A	\$169	\$81	\$30	CF	CF	\$711	\$80
ES2-30	30" 2 Col.	\$563	\$389	\$389	N/A	N/A	\$134	N/A	\$271	\$81	\$30	CF	CF	\$711	\$80
ES2-36	36" 2 Col.	\$653	\$389	\$389	N/A	N/A	\$134	N/A	\$271	\$81	\$30	CF	CF	\$711	\$80
ESX-20	20" X	\$673	N/A	N/A	N/A	\$112	\$134	N/A	\$271	\$163	\$61	CF	CF	N/A	\$80
ESX-26	26" X	\$732	N/A	N/A	N/A	\$112	\$134	N/A	\$271	\$163	\$61	CF	CF	N/A	\$80
ESX-30	30" X	\$780	N/A	N/A	N/A	\$112	\$134	N/A	\$271	\$163	\$61	CF	CF	N/A	\$80
ESX-36	36" X	\$878	N/A	N/A	N/A	\$112	\$134	N/A	\$271	\$163	\$61	CF	CF	N/A	\$80
ESX-36-4	36" X-(4) 2" Col.	\$1,131	N/A	N/A	N/A	\$112	\$134	N/A	\$271	\$163	\$61	CF	CF	N/A	\$80
ESX-42-4	42" X-(4) 2" Col.	\$1,131	N/A	N/A	N/A	\$112	\$134	N/A	\$271	\$163	\$61	CF	CF	N/A	\$80
EXCALIBUR SQUARED															
ESQ1-16	16" 1 Col.	\$502	CF	CF	N/A	N/A	\$134	N/A	\$169	\$81	\$30	N/A	N/A	N/A	\$80
ESQ1-20	20" 1 Col.	\$526	CF	CF	N/A	N/A	\$134	N/A	\$169	\$81	\$30	N/A	N/A	N/A	\$80
ESQ1-26	26" 1 Col.	\$561	CF	CF	N/A	N/A	\$134	N/A	\$169	\$81	\$30	N/A	N/A	N/A	\$80
ESQ2-30	30" 2 Col.	\$817	CF	CF	N/A	N/A	\$134	N/A	\$271	\$81	\$30	N/A	N/A	N/A	\$80



BASES ONLY

		OPTIONS													
		NESTING (Per 2 EB) - Under 84"	NESTING (Per 2 EB) - 84" & 96"	FOLDING	FLIP TOP	POWDERCOAT UPGRADE	UPGRADE FINISH (MIN. 10	CHROME	DELUXE CASTERS (BLK)	EQUALIZER GLIDES	ANGLE BASE (Per Table)	OFFSET BASE (Per Table)	ADJ. HEIGHT PIN (Per Table)	SPECIAL HEIGHT (Per	
BASE		ADD	ADD	ADD	ADD	ADD	ADD	ADD	ADD	ADD	ADD	ADD	ADD	ADD	
ESQ2-36	36" 2 Col.	\$852	CF	CF	N/A	N/A	\$134	N/A	\$271	\$81	\$30	N/A	N/A	N/A	\$80
ESQX-20X	20" X	\$896	N/A	N/A	N/A	N/A	\$134	N/A	\$271	\$163	\$61	N/A	N/A	N/A	\$80
ESQX-26X	26" X	\$966	N/A	N/A	N/A	N/A	\$134	N/A	\$271	\$163	\$61	N/A	N/A	N/A	\$80
ESQX-30X	30" X	\$1,015	N/A	N/A	N/A	N/A	\$134	N/A	\$271	\$163	\$61	N/A	N/A	N/A	\$80
ESQX-36X	36" X	\$1,085	N/A	N/A	N/A	N/A	\$134	N/A	\$271	\$163	\$61	N/A	N/A	N/A	\$80
FLEXCALIBUR															
ESQ1-22-ADJI 22"		\$2,302	N/A	N/A	N/A	N/A	N/A	N/A	N/A	N/A	N/A				
ESQ1-28-ADJI 28"		\$2,302	N/A	N/A	N/A	N/A	N/A	N/A	N/A	N/A	N/A				
ESQ1-22-ADJI 22" BIFMA		\$2,677	N/A	N/A	N/A	N/A	N/A	N/A	N/A	N/A	N/A				
ESQ1-28-ADJI 28" BIFMA		\$1,977	N/A	N/A	N/A	N/A	N/A	N/A	N/A	N/A	N/A				
PALISADE															
		LIMITED BASE FINISH OPTIONS - TEXTURED ONLY													
PAL-EB		\$79	N/A	N/A	N/A	N/A	\$134	\$34	N/A	\$41	\$16	N/A	N/A	N/A	N/A
PLATEAU															
PLX17X	17"x17"	\$722	N/A	N/A	N/A	N/A	\$134	N/A	N/A	N/A	N/A	N/A	N/A	N/A	\$80
PLX22X	22"x22"	\$929	N/A	N/A	N/A	N/A	\$134	N/A	N/A	N/A	N/A	N/A	N/A	N/A	\$80
PLX27X	27"x27"	\$1,223	N/A	N/A	N/A	N/A	\$134	N/A	N/A	N/A	N/A	N/A	N/A	N/A	\$80

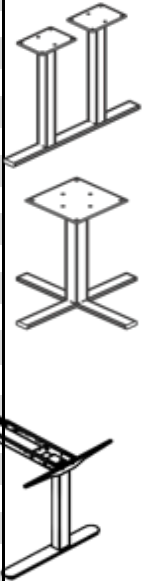

BASES ONLY

			OPTIONS						
			Grommet - Top	Grommet - Bottom	Two Grommets	Accessory Door 10"x10"	Accessory Door & Grommet Top	SPECIAL HEIGHT	
			ADD	ADD	ADD	ADD	ADD	ADD	
VOLUMA									
CC18	18"	Cylinder Laminate	\$1,203	\$121	\$121	\$242	\$716	\$811	\$237
CC24	24"	Cylinder Laminate	\$1,295	\$121	\$121	\$242	\$716	\$811	\$237
CC30	30"	Cylinder Laminate	\$1,425	\$121	\$121	\$242	\$716	\$811	\$237
CC36	36"	Cylinder Laminate	\$1,567	\$121	\$121	\$242	\$716	\$811	\$237
CCV18	18"	Cylinder Veneer	\$1,503	\$121	\$121	\$242	\$716	\$811	\$237
CCV24	24"	Cylinder Veneer	\$1,665	\$121	\$121	\$242	\$716	\$811	\$237
CCV30	30"	Cylinder Veneer	\$1,832	\$121	\$121	\$242	\$716	\$811	\$237
CCV36	36"	Cylinder Veneer	\$2,015	\$121	\$121	\$242	\$716	\$811	\$237
CH18	18"	1/2 Cylinder Laminate	\$1,295	\$121	\$121	\$242	\$716	\$811	\$237
CH24	24"	1/2 Cylinder Laminate	\$1,411	\$121	\$121	\$242	\$716	\$811	\$237
CHV18	18"	1/2 Cylinder Veneer	\$1,758	\$121	\$121	\$242	\$716	\$811	\$237
CHV24	24"	1/2 Cylinder Veneer	\$1,889	\$121	\$121	\$242	\$716	\$811	\$237
CP18	18"	Flat Panel Laminate	\$852	N/A	N/A	N/A	N/A	N/A	\$237
CP24	24"	Flat Panel Laminate	\$946	N/A	N/A	N/A	N/A	N/A	\$237
CP36	36"	Flat Panel Laminate	\$946	N/A	N/A	N/A	N/A	N/A	\$237
CO20	20"	Oval Laminate	\$1,154	N/A	N/A	N/A	N/A	N/A	\$237
CO26	26"	Oval Laminate	\$1,283	N/A	N/A	N/A	N/A	N/A	\$237
CO36	36"	Oval Laminate	\$1,283	N/A	N/A	N/A	N/A	N/A	\$237
COV20	20"	Oval Veneer	\$2,441	N/A	N/A	N/A	N/A	N/A	\$237
COV26	26"	Oval Veneer	\$2,712	N/A	N/A	N/A	N/A	N/A	\$237
COV36	36"	Oval Veneer	\$2,712	N/A	N/A	N/A	N/A	N/A	\$237
CB18	18"	Boat Laminate	\$1,154	N/A	N/A	N/A	N/A	N/A	\$237
CB24	24"	Boat Laminate	\$1,283	N/A	N/A	N/A	N/A	N/A	\$237
CB36	36"	Boat Laminate	\$1,283	N/A	N/A	N/A	N/A	N/A	\$237
CBV18	18"	Boat Veneer	\$2,441	N/A	N/A	N/A	N/A	N/A	\$237
CBV24	24"	Boat Veneer	\$2,712	N/A	N/A	N/A	N/A	N/A	\$237
CBV36	36"	Boat Veneer	\$2,712	N/A	N/A	N/A	N/A	N/A	\$237
CA18	18"	Arch Laminate	\$1,154	N/A	N/A	N/A	N/A	N/A	\$237
CA24	24"	Arch Laminate	\$1,283	N/A	N/A	N/A	N/A	N/A	\$237
CA36	36"	Arch Laminate	\$1,283	N/A	N/A	N/A	N/A	N/A	\$237
CAV18	18"	Arch Veneer	\$2,441	N/A	N/A	N/A	N/A	N/A	\$237
CAV24	24"	Arch Veneer	\$2,712	N/A	N/A	N/A	N/A	N/A	\$237
CAV36	36"	Arch Veneer	\$2,712	N/A	N/A	N/A	N/A	N/A	\$237
CSQ18	18"	Square Laminate	\$1,684	N/A	N/A	N/A	N/A	N/A	\$237
CSQ24	24"	Square Laminate	\$1,813	N/A	N/A	N/A	N/A	N/A	\$237
CSQ30	30"	Square Laminate	\$1,994	N/A	N/A	N/A	N/A	N/A	\$237
CSQ36	36"	Square Laminate	\$3,193	N/A	N/A	N/A	N/A	N/A	\$237
CSQV18	18"	Square Veneer	\$3,536	N/A	N/A	N/A	N/A	N/A	\$237
CSQV24	24"	Square Veneer	\$3,806	N/A	N/A	N/A	N/A	N/A	\$237
CSQV30	30"	Square Veneer	\$4,187	N/A	N/A	N/A	N/A	N/A	\$237
CSQV36	36"	Square Veneer	\$6,705	N/A	N/A	N/A	N/A	N/A	\$237

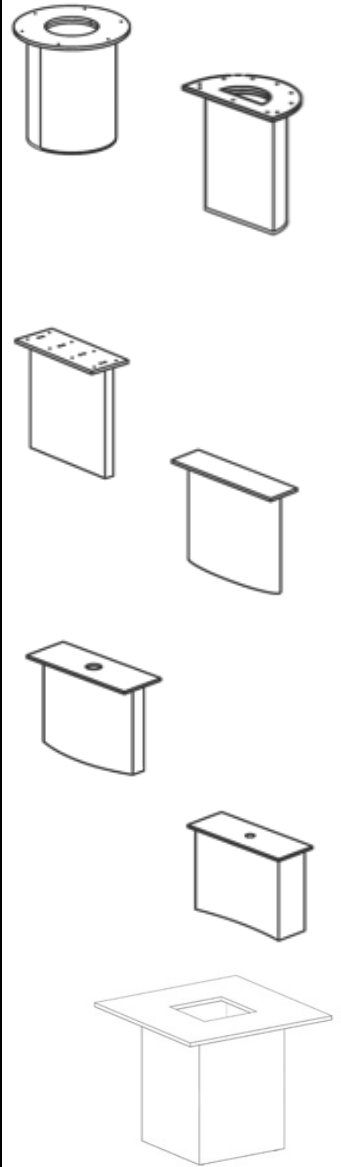

BASES ONLY



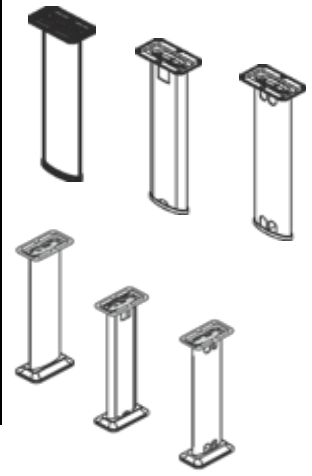













		OPTIONS						
		BASE	Grommet - Top	Grommet - Bottom	Two Grommets	Accessory Door 10"x10"	Accessory Door & Grommet Top	SPECIAL HEIGHT
			ADD	ADD	ADD	ADD	ADD	ADD
iQ CONFERENCE								
IQC	Standard Leg	\$392	N/A	N/A	N/A	N/A	N/A	N/A
IQC-E1	Removable Cover Leg	\$401	N/A	N/A	N/A	N/A	N/A	N/A
IQC-E2	Wire Mgt. Leg	\$446	N/A	N/A	N/A	N/A	N/A	N/A
iQ FIXED PEDESTAL								
IQ-PMB	Standard Leg	\$422	N/A	N/A	N/A	N/A	N/A	N/A
IQ-PMBE1	Removable Cover Leg	\$427	N/A	N/A	N/A	N/A	N/A	N/A
IQ-PMBE2	Wire Mgt. Leg	\$476	N/A	N/A	N/A	N/A	N/A	N/A



















TOPS ONLY



















TOPS ONLY - LAMINATE

	Edge Choices: PVC & T-Mold				Edge Choices: Wood (Red Oak & Maple)			Wood Upgrade	Laminate Upgrades		Light Weight
	 T-15	 L-21	 P-14	 PK-2	 W-12	 W-23	 W-19	Upgrade: Walnut / Mahogany / Cherry	Laminate Upgrade I	Laminate Upgrade II	Light Weight (PVC only - 1" top)
	 P-10 (self)	 P-12	 PK-4	 W-18	 W-17	 W-16	 W-32				
	 L-15		 L-23								
SQUARE (SQR)											
18x18	\$245	\$257	\$270	N/A	N/A	N/A	N/A	15%	\$18	\$49	\$43
24x24	\$310	\$326	\$341	\$620	\$775	\$930	15%	\$23	\$62	\$54	
30x30	\$389	\$408	\$428	\$778	\$972	\$1,167	15%	\$29	\$78	\$68	
36x36	\$482	\$506	\$530	\$964	\$1,205	\$1,445	15%	\$36	\$96	\$84	
42x42	\$589	\$618	\$647	\$1,619	\$2,060	\$2,355	15%	\$44	\$118	\$103	
48x48	\$709	\$745	\$780	\$1,951	\$2,483	\$2,838	15%	\$53	\$142	\$124	
54x54	\$844	\$886	\$929	N/A	N/A	N/A	N/A	\$63	\$169	N/A	
60x60	\$993	\$1,042	\$1,092	\$2,730	\$3,475	\$3,971	15%	\$74	\$199	N/A	
ROUND (RND)											
18	\$279	\$293	\$307	\$559	\$699	\$838	15%	\$21	\$56	\$49	
24	\$341	\$358	\$375	\$682	\$852	\$1,023	15%	\$26	\$68	\$60	
30	\$416	\$437	\$458	\$833	\$1,041	\$1,249	15%	\$31	\$83	\$73	
36	\$506	\$531	\$556	\$1,012	\$1,264	\$1,517	15%	\$38	\$101	\$89	
42	\$609	\$640	\$670	\$1,675	\$2,132	\$2,436	15%	\$46	\$122	\$107	
48	\$726	\$763	\$799	\$1,998	\$2,542	\$2,906	15%	\$54	\$145	\$127	
54	\$858	\$901	\$943	\$2,359	\$3,002	\$3,431	15%	\$64	\$172	\$150	
60	\$1,003	\$1,053	\$1,103	\$2,758	\$3,510	\$4,012	15%	\$75	\$201	\$176	
72 (2 piece)	\$1,810	\$1,900	\$1,991	\$4,977	\$6,335	\$7,240	15%	\$136	\$362	\$317	
RECTANGLE (REC)											
18x48	\$390	\$410	\$429	\$780	\$975	\$1,170	15%	\$29	\$78	\$68	
18x60	\$448	\$470	\$493	\$896	\$1,120	\$1,344	15%	\$34	\$90	\$78	
18x72	\$506	\$531	\$557	\$1,012	\$1,265	\$1,518	15%	\$38	\$101	\$89	
18x84	\$564	\$592	\$620	\$1,244	\$1,555	\$1,866	15%	\$42	\$113	\$99	
18x96	\$622	\$653	\$684	\$1,244	\$1,555	\$1,866	15%	\$47	\$124	\$109	
24x30	\$346	\$363	\$381	\$692	\$865	\$1,038	15%	\$26	\$69	\$61	
24x36	\$382	\$401	\$420	\$764	\$955	\$1,146	15%	\$29	\$76	\$67	

















TOPS ONLY - LAMINATE

	Edge Choices: PVC & T-Mold				Edge Choices: Wood (Red Oak & Maple)			Wood Upgrade	Laminate Upgrades		Light Weight
	 T-15	 L-21	 P-14	 PK-2	 W-12	 W-23	 W-19	Upgrade: Walnut / Mahogany / Cherry	Laminate Upgrade I	Laminate Upgrade II	Light Weight (PVC only - 1" top)
	 P-10 (self)	 P-12	 PK-4		 W-18	 W-17	ADD		ADD	ADD	
	 L-15		 L-23		 W-16	 W-32					
24x42	\$418		\$439	\$460	\$836	\$1,045	\$1,254	15%	\$31	\$84	\$73
24x48	\$454		\$477	\$499	\$908	\$1,135	\$1,362	15%	\$34	\$91	\$79
24x60	\$526		\$552	\$578	\$1,052	\$1,315	\$1,577	15%	\$39	\$105	\$92
24x72	\$598		\$628	\$658	\$1,195	\$1,494	\$1,793	15%	\$45	\$120	\$105
24x84	\$670		\$703	\$737	\$1,483	\$1,854	\$2,225	15%	\$50	\$134	\$117
24x96	\$742		\$779	\$816	\$1,483	\$1,854	\$2,225	15%	\$56	\$148	\$130
24x120 (1 piece)	\$885		\$930	\$974	\$1,720	\$2,151	\$2,581	15%	\$66	\$177	\$155
24x144 (1 piece)	\$1,029		\$1,081	\$1,132	\$1,996	\$2,495	\$2,994	15%	\$77	\$206	N/A
30x36	\$432		\$454	\$475	\$864	\$1,080	\$1,296	15%	\$32	\$86	\$76
30x42	\$475		\$499	\$522	\$950	\$1,187	\$1,425	15%	\$36	\$95	\$83
30x48	\$518		\$544	\$570	\$1,036	\$1,294	\$1,553	15%	\$39	\$104	\$91
30x60	\$604		\$634	\$664	\$1,207	\$1,509	\$1,811	15%	\$45	\$121	\$106
30x72	\$613		\$644	\$674	\$1,226	\$1,532	\$1,839	15%	\$46	\$123	\$107
30x84	\$775		\$814	\$853	\$1,723	\$2,153	\$2,584	15%	\$58	\$155	\$136
30x96	\$861		\$904	\$947	\$1,723	\$2,153	\$2,584	15%	\$65	\$172	\$151
30x120 (1 piece)	\$1,033		\$1,085	\$1,136	\$1,998	\$2,498	\$2,997	15%	\$77	\$207	N/A
30x144 (1 piece)	\$1,205		\$1,265	\$1,325	\$2,318	\$2,897	\$3,477	15%	\$90	\$241	N/A
36x42	\$532		\$558	\$585	\$1,063	\$1,329	\$1,595	15%	\$40	\$106	\$93
36x48	\$582		\$611	\$640	\$1,163	\$1,454	\$1,745	15%	\$44	\$116	\$102
36x60	\$681		\$750	\$818	\$1,363	\$1,704	\$2,044	15%	\$51	\$136	\$119
36x72	\$781		\$820	\$859	\$1,563	\$1,953	\$2,344	15%	\$59	\$156	\$137
36x84	\$881		\$925	\$969	\$1,962	\$2,452	\$2,943	15%	\$66	\$176	\$154
36x96	\$981		\$1,030	\$1,079	\$1,962	\$2,452	\$2,943	15%	\$74	\$196	\$172
36x120 (1 piece)	\$1,181		\$1,240	\$1,299	\$2,361	\$2,952	\$3,542	15%	\$89	\$236	N/A
36x144 (1 piece)	\$1,380		\$1,449	\$1,518	\$1,775	\$2,259	\$2,582	15%	\$104	\$276	N/A
42x48	\$646		\$678	\$710	\$1,775	\$2,259	\$2,582	15%	\$48	\$129	\$113
42x60	\$759		\$797	\$835	\$2,088	\$2,658	\$3,037	15%	\$57	\$152	\$133
42x72	\$873		\$917	\$960	\$2,401	\$3,056	\$3,493	15%	\$65	\$175	\$153
42x84	\$987		\$1,036	\$1,086	\$2,714	\$3,454	\$3,947	15%	\$74	\$197	\$173
42x96	\$1,101		\$1,156	\$1,211	\$3,039	\$3,868	\$4,421	15%	\$83	\$220	\$193
42x120 (1 piece)	\$1,328		\$1,395	\$1,461	\$3,677	\$4,680	\$5,349	15%	\$100	\$266	\$232
42x144 (1 piece)	\$1,556		\$1,634	\$1,711	\$4,302	\$5,476	\$6,258	15%	\$117	\$311	\$272
48x60	\$837		\$879	\$921	\$2,302	\$2,930	\$3,349	15%	\$63	\$167	\$146
48x72	\$965		\$1,013	\$1,061	\$2,653	\$3,377	\$3,860	15%	\$72	\$193	\$169
48x84	\$1,093		\$1,147	\$1,202	\$3,356	\$4,271	\$4,881	15%	\$82	\$219	\$191
48x96	\$1,220		\$1,281	\$1,342	\$3,356	\$4,271	\$4,881	15%	\$92	\$244	\$214
48x120 (1 piece)	\$1,476		\$1,550	\$1,623	\$4,059	\$5,166	\$5,903	15%	\$111	\$295	N/A
48x144 (1 piece)	\$1,731		\$1,818	\$1,904	\$4,761	\$6,060	\$6,925	15%	\$130	\$346	N/A
48x168 (2 pieces)	\$1,987		\$2,086	\$2,186	\$5,464	\$6,954	\$7,947	15%	\$149	\$397	N/A
48x192 (2 pieces)	\$2,242		\$2,354	\$2,467	\$6,166	\$7,848	\$8,969	15%	\$168	\$448	N/A
48x216 (2 pieces)	\$2,498		\$2,623	\$2,748	\$6,906	\$8,790	\$10,046	15%	\$187	\$500	N/A

















TOPS ONLY - LAMINATE

	Edge Choices: PVC & T-Mold				Edge Choices: Wood (Red Oak & Maple)			Wood Upgrade	Laminate Upgrades		Light Weight
	 T-15	 L-21	 P-14	 PK-2	 W-12	 W-23	 W-19	Upgrade: Walnut / Mahogany / Cherry ADD	Laminate Upgrade I	Laminate Upgrade II	Light Weight (PVC only - 1" top) ADD
	 P-10 (self)	 P-12		 PK-4		 W-18	 W-17			ADD	
	 L-15			 L-23		 W-16	 W-32				
48x240 (2 pieces)	\$2,753	\$2,891	\$3,029	\$7,572	\$9,637	\$11,013	15%	\$206	\$551	N/A	
60x96	\$1,460	\$1,533	\$1,606	\$4,014	\$5,109	\$5,839	15%	\$109	\$292	N/A	
60x120 (1 piece)	\$1,771	\$1,860	\$1,948	\$4,870	\$6,199	\$7,084	15%	\$133	\$354	N/A	
60x144 (1 piece)	\$2,082	\$2,187	\$2,291	\$5,727	\$7,288	\$8,330	15%	\$156	\$416	N/A	
60x168 (2 pieces)	\$2,394	\$2,513	\$2,633	\$6,583	\$8,378	\$9,575	15%	\$180	\$479	N/A	
60x192 (2 pieces)	\$2,705	\$2,840	\$2,976	\$7,439	\$9,468	\$10,820	15%	\$203	\$541	N/A	
60x216 (2 pieces)	\$3,016	\$3,167	\$3,318	\$8,295	\$10,557	\$12,065	15%	\$226	\$603	N/A	
60x240 (2 pieces)	\$3,328	\$3,494	\$3,660	\$9,151	\$11,647	\$13,311	15%	\$250	\$666	N/A	
											
RACETRACK (RAC)											
30x60	\$693	\$728	\$762	\$1,741	\$2,177	\$2,612	15%	\$52	\$139	\$121	
36x72	\$871	\$914	\$958	\$1,741	\$2,177	\$2,612	15%	\$65	\$174	\$152	
36x84	\$971	\$1,019	\$1,068	\$2,141	\$2,676	\$3,211	15%	\$73	\$194	\$170	
36x96	\$1,070	\$1,124	\$1,177	\$2,141	\$2,676	\$3,211	15%	\$80	\$214	\$187	
36x120 (1 piece)	\$1,270	\$1,334	\$1,397	\$2,540	\$3,175	\$3,810	15%	\$95	\$254	N/A	
36x144 (1 piece)	\$1,470	\$1,543	\$1,617	\$2,946	\$3,683	\$4,420	15%	\$110	\$294	N/A	
42x84	\$1,076	\$1,130	\$1,184	\$1,883	\$2,354	\$2,825	15%	\$81	\$215	\$188	
42x96	\$1,190	\$1,250	\$1,309	\$2,083	\$2,603	\$3,124	15%	\$89	\$238	\$208	
42x120 (1 piece)	\$1,418	\$1,489	\$1,559	\$2,481	\$3,101	\$3,721	15%	\$106	\$284	N/A	
42x144 (1 piece)	\$1,645	\$1,727	\$1,810	\$2,879	\$3,599	\$4,319	15%	\$123	\$329	N/A	
48x96	\$1,310	\$1,375	\$1,441	\$3,602	\$4,584	\$5,239	15%	\$98	\$262	\$229	
48x120 (1 piece)	\$1,565	\$1,644	\$1,722	\$4,304	\$5,478	\$6,261	15%	\$117	\$313	N/A	
48x144 (1 piece)	\$1,821	\$1,912	\$2,003	\$5,007	\$6,373	\$7,283	15%	\$137	\$364	N/A	
48x168 (2 pieces)	\$2,076	\$2,180	\$2,284	\$5,710	\$7,267	\$8,305	15%	\$156	\$415	N/A	
48x192 (2 pieces)	\$2,332	\$2,448	\$2,565	\$6,412	\$8,161	\$9,327	15%	\$175	\$466	N/A	
48x216 (2 pieces)	\$2,587	\$2,717	\$2,846	\$4,528	\$5,659	\$6,791	15%	\$194	\$517	N/A	
48x240 (2 pieces)	\$2,843	\$2,985	\$3,127	\$7,817	\$9,949	\$11,371	15%	\$213	\$569	N/A	
60x96	\$1,549	\$1,627	\$1,704	\$4,260	\$5,422	\$6,197	15%	\$116	\$310	N/A	
60x120 (1 piece)	\$1,860	\$1,953	\$2,047	\$5,116	\$6,512	\$7,442	15%	\$140	\$372	N/A	
60x144 (1 piece)	\$2,172	\$2,280	\$2,389	\$5,972	\$7,601	\$8,687	15%	\$163	\$434	N/A	
60x168 (2 pieces)	\$2,483	\$2,607	\$2,731	\$6,829	\$8,691	\$9,932	15%	\$186	\$497	N/A	
60x192 (2 pieces)	\$2,794	\$2,934	\$3,074	\$7,685	\$9,780	\$11,178	15%	\$210	\$559	N/A	
60x216 (2 pieces)	\$3,106	\$3,261	\$3,416	\$8,541	\$10,870	\$12,423	15%	\$233	\$621	N/A	
60x240 (2 pieces)	\$3,417	\$3,588	\$3,759	\$9,397	\$11,960	\$13,668	15%	\$256	\$683	N/A	

















TOPS ONLY - LAMINATE

	Edge Choices: PVC & T-Mold				Edge Choices: Wood (Red Oak & Maple)			Wood Upgrade	Laminate Upgrades		Light Weight
	 T-15	 L-21	 P-14	 PK-2	 W-12	 W-23	 W-19	Upgrade: Walnut / Mahogany / Cherry	Laminate Upgrade I	Laminate Upgrade II	Light Weight (PVC only - 1" top)
	 P-10 (self)	 P-12		 PK-4		 W-18	 W-17	ADD	ADD	ADD	ADD
	 L-15		 L-23		 W-16	 W-32					
BOAT (BOT)											
36x48x96	\$1,310	\$1,375	\$1,441	\$2,620	\$3,274	\$3,929	15%	\$98	\$262	\$229	
36x48x120 (1 piece)	\$1,565	\$1,644	\$1,722	\$3,130	\$3,913	\$4,696	15%	\$117	\$313	N/A	
36x48x144 (1 piece)	\$1,821	\$1,912	\$2,003	\$3,186	\$3,983	\$4,779	15%	\$137	\$364	N/A	
42x54x120 (1 piece)	\$1,713	\$1,798	\$1,884	\$2,997	\$3,747	\$4,496	15%	\$128	\$343	N/A	
42x54x144 (1 piece)	\$1,996	\$2,096	\$2,196	\$3,493	\$4,367	\$5,240	15%	\$150	\$399	N/A	
48x60x144 (1 piece)	\$2,172	\$2,280	\$2,389	\$5,972	\$7,601	\$8,687	15%	\$163	\$434	N/A	
48x60x168 (2 pieces)	\$2,483	\$2,607	\$2,731	\$6,829	\$8,691	\$9,932	15%	\$186	\$497	N/A	
48x60x192 (2 pieces)	\$2,794	\$2,934	\$3,074	\$7,685	\$9,780	\$11,178	15%	\$210	\$559	N/A	
48x60x216 (2 pieces)	\$3,106	\$3,261	\$3,416	\$5,435	\$6,794	\$8,153	15%	\$233	\$621	N/A	
48x60x240 (2 pieces)	\$3,417	\$3,588	\$3,759	\$9,397	\$11,960	\$13,668	15%	\$256	\$683	N/A	
OVAL (OVL)											
36x60	\$771	\$809	\$848	\$1,741	\$2,177	\$2,612	15%	\$58	\$154	\$135	
36x72	\$871	\$914	\$958	\$1,741	\$2,177	\$2,612	15%	\$65	\$174	\$152	
36x84	\$971	\$1,019	\$1,068	\$2,141	\$2,676	\$3,211	15%	\$73	\$194	\$170	
36x96	\$1,070	\$1,124	\$1,177	\$2,141	\$2,676	\$3,211	15%	\$80	\$214	\$187	
42x72	\$962	\$1,011	\$1,059	\$1,684	\$2,105	\$2,527	15%	\$72	\$192	\$168	
42x84	\$1,076	\$1,130	\$1,184	\$1,883	\$2,354	\$2,825	15%	\$81	\$215	\$188	
42x96	\$1,190	\$1,250	\$1,309	\$2,083	\$2,603	\$3,124	15%	\$89	\$238	\$208	
48x84	\$1,182	\$1,241	\$1,300	\$2,069	\$2,586	\$3,103	15%	\$89	\$236	\$207	
48x96	\$1,310	\$1,375	\$1,441	\$3,602	\$4,584	\$5,239	15%	\$98	\$262	\$229	
48x120 (1 piece)	\$1,565	\$1,644	\$1,722	\$4,304	\$5,478	\$6,261	15%	\$117	\$313	N/A	
48x144 (1 piece)	\$1,821	\$1,912	\$2,003	\$5,007	\$6,373	\$7,283	15%	\$137	\$364	N/A	
60x120 (1 piece)	\$1,860	\$1,953	\$2,047	\$5,116	\$6,512	\$7,442	15%	\$140	\$372	N/A	
60x144 (1 piece)	\$2,172	\$2,280	\$2,389	\$5,972	\$7,601	\$8,687	15%	\$163	\$434	N/A	
60x168 (2 pieces)	\$2,483	\$2,607	\$2,731	\$6,829	\$8,691	\$9,932	15%	\$186	\$497	N/A	

TOPS ONLY - LAMINATE

	Edge Choices: PVC & T-Mold				Edge Choices: Wood (Red Oak & Maple)			Wood Upgrade	Laminate Upgrades		Light Weight
	 T-15	 L-21	 P-14	 PK-2	 W-12	 W-23	 W-19	Upgrade: Walnut / Mahogany / Cherry	Laminate Upgrade I	Laminate Upgrade II	Light Weight (PVC only - 1" top)
	 P-10 (self)	 P-12	 PK-4	 W-18	 W-17	 W-16	 W-32				
	 L-15		 L-23								
TRAPEZOID (TRP)											
24x24x48	\$543	\$570	\$598	\$951	\$1,188	\$1,426	15%	\$41	\$109	\$95	
24x36x60	\$771	\$809	\$848	\$1,349	\$1,686	\$2,024	15%	\$58	\$154	\$135	
30x30x60	\$693	\$728	\$762	\$1,213	\$1,516	\$1,819	15%	\$52	\$139	\$121	
30x42x72	\$962	\$1,011	\$1,059	\$1,684	\$2,105	\$2,527	15%	\$72	\$192	\$168	
36x36x72	\$871	\$914	\$958	\$1,524	\$1,905	\$2,286	15%	\$65	\$174	\$152	
HALF RND (HRD)											
24x48	\$485	\$509	\$533	\$848	\$1,060	\$1,273	15%	\$36	\$97	\$85	
30x60	\$631	\$663	\$694	\$1,104	\$1,380	\$1,657	15%	\$47	\$126	\$110	
36x72	\$805	\$846	\$886	\$1,409	\$1,761	\$2,114	15%	\$60	\$161	\$141	
QTR ROUND (QRD)											
24x24	\$355	\$373	\$390	\$621	\$776	\$931	15%	\$27	\$71	\$62	
30x30	\$434	\$455	\$477	\$759	\$949	\$1,138	15%	\$33	\$87	\$76	
36x36	\$527	\$553	\$579	\$921	\$1,152	\$1,382	15%	\$39	\$105	\$92	
CRESCENT (CRT)											
24x24x48	\$543	\$570	\$598	\$951	\$1,188	\$1,426	15%	\$41	\$109	\$95	
30x30x60	\$693	\$728	\$762	\$1,213	\$1,516	\$1,819	15%	\$52	\$139	\$121	
36x36x72	\$871	\$914	\$958	\$1,524	\$1,905	\$2,286	15%	\$65	\$174	\$152	

TOPS ONLY - LAMINATE

Edge Choices: PVC & T-Mold				Edge Choices: Wood (Red Oak & Maple)			Wood Upgrade	Laminate Upgrades		Light Weight			
 T-15	 L-21	 P-14	 PK-2	 W-12	 W-23	 W-19	Upgrade: Walnut / Mahogany / Cherry ADD	Laminate Upgrade I ADD	Laminate Upgrade II ADD	Light Weight (PVC only - 1" top) ADD			
 P-10 (self)	 P-12		 PK-4	 W-18	 W-17								
 L-15			 L-23	 W-16	 W-32								

Call For Price Quote:

Solid Surface
Veneer - Light Weight

Laminate Finish Grades:

Standard Laminate: Wilsonart: 38 & 60; Pionite: Suede (N); Nevamar: T, E, N, V;
Formica: Finish 43, 58, MicroDot

Upgrade Laminate I: Wilsonart: 1, 7, 12, 18, 78 & 52; Pionite: Hi-Brite (H), Crystal (J), Wood Essence (I), Ashwood (Z), Super Matte (F), Line Z (OZ), Linen (OL), Embossed Leather (L), Soft Leather, Embossed Slate (W), Medium Gloss (U), Gloss; Nevamar: G, CV, CR/K, B, BG, PV, S, Z;
Formica: 42, 90, NG, RD

Upgrade Laminate II: Wilsonart: 35, 45 & 55; Pionite: Granite, Stone X (V), Pearlescent; Markerboard laminate

For Finishes other than the Manufacturer's "standard" finish, pricing moves to the next highest category.

TOPS ONLY - LOW PRESSURE LAMINATE (VALUE LINE)

**Edge 3MM PVC Top
Match Top**



SQUARE (SQR)

18x18	\$86
24x24	\$125
30x30	\$173
36x36	\$230
42x42	\$297
48x48	\$373



ROUND (RND)



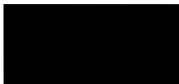



18	\$86
24	\$125
30	\$173
36	\$230
42	\$297
48	\$373



RECTANGLE (REC)







18x48	\$171
18x60	\$205
18x72	\$239
24x30	\$147
24x36	\$168
24x42	\$190
24x48	\$212
24x60	\$255
24x72	\$298
30x36	\$199
30x42	\$225
30x48	\$252
30x60	\$304
30x72	\$357
36x42	\$261
36x48	\$292
36x60	\$354
36x72	\$416

TOPS ONLY - VENEER







	Edge Choices: Wood (Red Oak & Maple)			Wood Upgrade
	 V-12	 V-23	 V-19	Upgrade: Walnut / Mahogany / Cherry ADD
		 V-18	 V-17	
		 V-16	 V-32	
SQUARE (SQR)				
24x24	\$684	\$821	\$890	15%
30x30	\$878	\$1,053	\$1,141	15%
36x36	\$1,258	\$1,509	\$1,635	15%
42x42	\$1,711	\$2,053	\$2,225	15%
48x48	\$2,238	\$2,685	\$2,909	15%
54x54	N/A	N/A	N/A	N/A
60x60	\$3,496	\$4,195	\$4,544	15%
ROUND (RND)				
18	\$658	\$790	\$856	15%
24	\$807	\$969	\$1,050	15%
30	\$1,046	\$1,255	\$1,359	15%
36	\$1,506	\$1,808	\$1,958	15%
42	\$2,055	\$2,466	\$2,671	15%
48	\$2,684	\$3,221	\$3,489	15%
54	\$3,401	\$4,081	\$4,421	15%
60	\$4,190	\$5,028	\$5,447	15%
72 (2 piece)	\$6,362	\$7,635	\$8,271	15%
RECTANGLE (REC)				
18x48	\$1,141	\$1,369	\$1,483	15%
18x60	\$1,419	\$1,702	\$1,844	15%
18x72	\$1,704	\$2,045	\$2,215	15%
18x84	\$2,274	\$2,729	\$2,957	15%
18x96	\$2,274	\$2,729	\$2,957	15%
24x30	\$709	\$851	\$922	15%
24x36	\$856	\$1,027	\$1,112	15%
24x42	\$1,031	\$1,237	\$1,340	15%
24x48	\$1,141	\$1,369	\$1,483	15%
24x60	\$1,419	\$1,702	\$1,844	15%
24x72	\$1,704	\$2,045	\$2,215	15%
24x84	\$2,274	\$2,729	\$2,957	15%



TOPS ONLY - VENEER

	Edge Choices: Wood (Red Oak & Maple)			wood Upgrade
	 V-12	 V-23	 V-19	Upgrade: Walnut / Mahogany / Cherry ADD
	 V-18	 V-17		
	 V-16	 V-32		
24x96	\$2,274	\$2,729	\$2,957	15%
24x120 (1 piece)	\$3,025	\$3,630	\$3,932	15%
24x144 (1 piece)	\$3,781	\$4,537	\$4,915	15%
30x36	\$1,053	\$1,264	\$1,369	15%
30x42	\$1,258	\$1,509	\$1,635	15%
30x48	\$1,397	\$1,676	\$1,816	15%
30x60	\$1,748	\$2,097	\$2,272	15%
30x72	\$2,099	\$2,519	\$2,728	15%
30x84	\$2,801	\$3,361	\$3,641	15%
30x96	\$2,801	\$3,361	\$3,641	15%
30x120 (1 piece)	\$3,725	\$4,470	\$4,843	15%
30x144 (1 piece)	\$4,656	\$5,588	\$6,053	15%
36x42	\$1,506	\$1,808	\$1,958	15%
36x48	\$1,682	\$2,018	\$2,187	15%
36x60	\$2,099	\$2,519	\$2,728	15%
36x72	\$2,516	\$3,019	\$3,270	15%
36x84	\$3,357	\$4,028	\$4,364	15%
36x96	\$3,357	\$4,028	\$4,364	15%
36x120 (1 piece)	\$4,468	\$5,362	\$5,809	15%
36x144 (1 piece)	\$5,585	\$6,702	\$7,261	15%
42x48	\$1,960	\$2,352	\$2,548	15%
42x60	\$2,450	\$2,940	\$3,185	15%
42x72	\$2,940	\$3,528	\$3,822	15%
42x84	\$3,910	\$4,692	\$5,083	15%
42x96	\$3,910	\$4,692	\$5,083	15%
42x120 (1 piece)	\$5,200	\$6,240	\$6,760	15%
42x144 (1 piece)	\$6,500	\$7,800	\$8,450	15%
48x60	\$2,801	\$3,361	\$3,641	15%
48x72	\$3,357	\$4,028	\$4,364	15%
48x84	\$4,476	\$5,371	\$5,818	15%
48x96	\$4,476	\$5,371	\$5,818	15%
48x120 (1 piece)	\$5,960	\$7,152	\$7,748	15%
48x144 (1 piece)	\$7,152	\$8,583	\$9,298	15%
48x168 (2 pieces)	\$8,344	\$10,013	\$10,847	15%
48x192 (2 pieces)	\$9,536	\$11,443	\$12,397	15%
48x216 (2 pieces)	\$11,920	\$14,304	\$15,496	15%
48x240 (2 pieces)	\$11,920	\$14,304	\$15,496	15%
60x96	\$5,960	\$7,152	\$7,748	15%
60x120 (1 piece)	\$7,452	\$8,942	\$9,688	15%
60x144 (1 piece)	\$8,944	\$10,733	\$11,627	15%
60x168 (2 pieces)	\$10,428	\$12,514	\$13,557	15%
60x192 (2 pieces)	\$11,920	\$14,304	\$15,496	15%
60x216 (2 pieces)	\$13,412	\$16,094	\$17,436	15%
60x240 (2 pieces)	\$14,904	\$17,885	\$19,375	15%

TOPS ONLY - VENEER

Edge Choices: Wood (Red Oak & Maple)			Wood Upgrade
 V-12	 V-23	 V-19	Upgrade: Walnut / Mahogany / Cherry ADD
	 V-18	 V-17	
	 V-16	 V-32	



RACETRACK (RAC)







30x60	\$3,057	\$3,668	\$3,974	15%
36x72	\$3,057	\$3,668	\$3,974	15%
36x84	\$3,891	\$4,669	\$5,058	15%
36x96	\$3,891	\$4,669	\$5,058	15%
36x120 (1 piece)	\$5,002	\$6,003	\$6,503	15%
36x144 (1 piece)	\$6,253	\$7,503	\$8,128	15%
42x84	\$4,863	\$5,836	\$6,322	15%
42x96	\$4,863	\$5,836	\$6,322	15%
42x120 (1 piece)	\$6,253	\$7,503	\$8,128	15%
42x144 (1 piece)	\$7,816	\$9,379	\$10,160	15%
48x96	\$5,009	\$6,011	\$6,512	15%
48x120 (1 piece)	\$6,494	\$7,793	\$8,442	15%
48x144 (1 piece)	\$7,686	\$9,223	\$9,992	15%
48x168 (2 pieces)	\$8,878	\$10,654	\$11,541	15%
48x192 (2 pieces)	\$10,070	\$12,084	\$13,091	15%
48x216 (2 pieces)	\$12,587	\$15,105	\$16,364	15%
48x240 (2 pieces)	\$12,454	\$14,945	\$16,190	15%
60x96	\$6,494	\$7,793	\$8,442	15%
60x120 (1 piece)	\$7,986	\$9,583	\$10,382	15%
60x144 (1 piece)	\$9,478	\$11,373	\$12,321	15%
60x168 (2 pieces)	\$10,962	\$13,155	\$14,251	15%
60x192 (2 pieces)	\$12,454	\$14,945	\$16,190	15%
60x216 (2 pieces)	\$13,946	\$16,735	\$18,130	15%
60x240 (2 pieces)	\$15,438	\$18,525	\$20,069	15%



BOAT (BOT)

36x48x96	\$4,337	\$5,204	\$5,638	15%
36x48x120 (1 piece)	\$5,697	\$6,836	\$7,406	15%
36x48x144 (1 piece)	\$7,121	\$8,545	\$9,257	15%
42x54x120 (1 piece)	\$7,121	\$8,545	\$9,257	15%
42x54x144 (1 piece)	\$15,310	\$18,372	\$19,903	15%
48x60x144 (1 piece)	\$8,673	\$10,408	\$11,275	15%
48x60x168 (2 pieces)	\$10,121	\$12,145	\$13,158	15%
48x60x192 (2 pieces)	\$11,569	\$13,883	\$15,040	15%
48x60x216 (2 pieces)	\$14,461	\$17,354	\$18,800	15%
48x60x240 (2 pieces)	\$14,458	\$17,349	\$18,795	15%

TOPS ONLY - VENEER

Edge Choices: Wood (Red Oak & Maple)			Wood Upgrade
 V-12	 V-23	 V-19	Upgrade: Walnut / Mahogany / Cherry ADD
	 V-18	 V-17	
	 V-16	 V-32	



OVAL (OVL)

36x60	\$3,335	\$4,002	\$4,335	15%
36x72	\$3,335	\$4,002	\$4,335	15%
36x84	\$4,446	\$5,336	\$5,780	15%
36x96	\$4,446	\$5,336	\$5,780	15%
42x72	\$4,168	\$5,002	\$5,419	15%
42x84	\$5,558	\$6,669	\$7,225	15%
42x96	\$5,558	\$6,669	\$7,225	15%
48x84	\$6,947	\$8,337	\$9,032	15%
48x96	\$5,638	\$6,766	\$7,330	15%
48x120 (1 piece)	\$7,408	\$8,890	\$9,630	15%
48x144 (1 piece)	\$8,893	\$10,671	\$11,560	15%
60x120 (1 piece)	\$9,266	\$11,119	\$12,045	15%
60x144 (1 piece)	\$11,116	\$13,339	\$14,450	15%
60x168 (2 pieces)	\$12,966	\$15,559	\$16,856	15%



TRAPEZOID (TRP)

24x24x48	CF	CF	CF	CF
24x36x60	CF	CF	CF	CF
30x30x60	CF	CF	CF	CF
30x42x72	CF	CF	CF	CF
36x36x72	CF	CF	CF	CF











HALF RND (HRD)

24x48	CF	CF	CF	CF
30x60	CF	CF	CF	CF
36x72	CF	CF	CF	CF



TOPS ONLY - VENEER

	Edge Choices: Wood (Red Oak & Maple)			Wood Upgrade
	 V-12	 V-23	 V-19	Upgrade: Walnut / Mahogany / Cherry
		 V-18	 V-17	
		 V-16	 V-32	
				ADD
QTR ROUND (QRD)				
24x24	CF	CF	CF	CF
30x30	CF	CF	CF	CF
36x36	CF	CF	CF	CF
				
CRESCENT (CRT)				
24 x 24 x 48 CRT	CF	CF	CF	CF
30 x 30 x 60 CRT	CF	CF	CF	CF
36 x 36 x 72 CRT	CF	CF	CF	CF

QTR ROUND (QRD)













24x24	CF	CF	CF	CF
30x30	CF	CF	CF	CF
36x36	CF	CF	CF	CF















CRESCENT (CRT)

24 x 24 x 48 CRT	CF	CF	CF	CF
30 x 30 x 60 CRT	CF	CF	CF	CF
36 x 36 x 72 CRT	CF	CF	CF	CF

TOPS ONLY - LAMINATE WITH SPECIALTY EDGE

	Comfort Edge		Molded Urethane Edge				Rainbow Resin Edge				Upgrade Choices	
	 LC-9	 MC-9*	 MR-1	 MR-2	 MR-6	 MA-2	 R-2	 R-1	 R-9	 R-5	Polished Edge	1-3/4" Rad. Corner
								 R-6	 R-7		ADD	ADD
SQUARE (SQR)												
24x24	N/A	N/A	\$936	\$921	\$899	\$936	\$1,009	\$1,170	\$1,331	\$1,060	10%	15%
30x30	N/A	N/A	\$1,097	\$1,082	\$1,075	\$1,097	\$1,075	\$1,243	\$1,411	\$1,126	10%	15%
36x36	N/A	N/A	\$1,346	\$1,258	\$1,214	\$1,346	\$1,287	\$1,485	\$1,689	\$1,353	10%	15%
42x42	N/A	N/A	\$1,499	\$1,463	\$1,404	\$1,499	\$1,762	\$2,033	\$2,311	\$1,850	10%	15%
48x48	N/A	N/A	\$1,550	\$1,536	\$1,463	\$1,550	\$2,304	\$2,655	\$3,020	\$2,413	10%	15%
54x54	N/A	N/A	N/A	N/A	N/A	N/A	\$2,896	\$3,349	\$3,803	\$3,042	10%	15%
60x60	N/A	N/A	N/A	N/A	N/A	N/A	\$3,583	\$4,139	\$4,702	\$3,759	10%	15%
ROUND (RND)												
24	N/A	N/A	\$1,009	\$965	\$921	\$1,009	\$1,009	\$1,170	\$1,331	\$1,060	10%	15%
30	N/A	N/A	\$1,141	\$1,097	\$1,046	\$1,141	\$1,075	\$1,243	\$1,411	\$1,126	10%	15%
36	N/A	N/A	\$1,353	\$1,316	\$1,251	\$1,353	\$1,287	\$1,485	\$1,689	\$1,353	10%	15%
42	N/A	N/A	\$1,521	\$1,463	\$1,389	\$1,521	\$1,762	\$2,033	\$2,311	\$1,850	10%	15%
48	N/A	N/A	\$1,828	\$1,770	\$1,726	\$1,828	\$2,304	\$2,655	\$3,020	\$2,413	10%	15%
54	N/A	N/A	\$2,304	\$2,267	\$2,209	\$2,304	\$2,896	\$3,349	\$3,803	\$3,042	10%	15%
60	N/A	N/A	\$2,486	\$2,413	\$2,355	N/A	\$3,583	\$3,056	\$4,702	\$3,759	10%	15%
RECTANGLE (REC)												
18x48	\$449	N/A	N/A	N/A	N/A	N/A	\$1,000	\$1,139	\$1,297	\$1,033	10%	15%
18x60	\$515	N/A	N/A	N/A	N/A	N/A	\$1,251	\$1,382	\$1,645	\$1,316	10%	15%
18x72	\$582	N/A	N/A	N/A	N/A	N/A	\$1,501	\$1,659	\$1,975	\$1,580	10%	15%
18x84	\$649	N/A	N/A	N/A	N/A	N/A	\$1,751	\$1,935	\$2,304	\$1,843	10%	15%
18x96	\$726	N/A	N/A	N/A	N/A	N/A	\$2,001	\$2,211	\$2,633	\$2,106	10%	15%
24x30	\$381	\$622	\$995	\$965	\$936	\$995	\$936	\$1,075	\$1,221	\$980	10%	15%
24x36	\$423	\$670	\$1,024	\$995	\$958	N/A	\$973	\$1,119	\$1,272	\$1,017	10%	15%
24x42	\$470	\$792	\$1,097	\$1,053	\$995	N/A	\$1,070	\$1,231	\$1,400	\$1,118	10%	15%
24x48	\$522	\$865	\$1,141	\$1,097	\$1,053	N/A	\$1,112	\$1,265	\$1,441	\$1,148	10%	15%
24x60	\$605	\$987	\$1,338	\$1,309	\$1,236	N/A	\$1,389	\$1,536	\$1,828	\$1,463	10%	15%
24x72	\$687	\$1,060	\$1,463	\$1,419	\$1,375	N/A	\$1,667	\$1,843	\$2,194	\$1,755	10%	15%
24x84	\$770	N/A	N/A	N/A	N/A	N/A	\$1,945	\$2,150	\$2,560	\$2,048	10%	15%
24x96	\$863	N/A	N/A	N/A	N/A	N/A	\$2,223	\$2,457	\$2,925	\$2,340	10%	15%
24x120 (1 piece)	N/A	N/A	N/A	N/A	N/A	N/A	\$2,779	\$3,071	\$3,656	\$2,925	10%	15%
24x144 (1 piece)	N/A	N/A	N/A	N/A	N/A	N/A	N/A	N/A	N/A	N/A	N/A	N/A
30x36	\$482	\$811	N/A	N/A	N/A	N/A	\$1,046	\$1,177	\$1,221	\$1,097	10%	15%
30x42	\$536	\$871	\$1,243	\$1,221	\$1,199	N/A	\$1,214	\$1,346	\$1,602	\$1,280	10%	15%

TOPS ONLY - LAMINATE WITH SPECIALTY EDGE

	Comfort Edge		Molded Urethane Edge				Rainbow Resin Edge				Upgrade Choices	
	 LC-9	 MC-9*	 MR-1	 MR-2	 MR-6	 MA-2	 R-2	 R-1	 R-9	 R-5	Polished Edge	1-3/4" Rad. Corner
								 R-6	 R-7		ADD	ADD
30x48	\$595	\$957	\$1,360	\$1,331	\$1,316	N/A	\$1,389	\$1,536	\$1,828	\$1,463	10%	15%
30x60	\$694	\$1,079	\$1,814	\$1,784	\$1,755	N/A	\$1,740	\$1,923	\$2,289	\$1,828	10%	15%
30x72	\$705	\$1,152	\$1,836	\$1,814	\$1,799	N/A	\$2,084	\$2,304	\$2,742	\$2,194	10%	15%
30x84	\$892	N/A	N/A	N/A	N/A	N/A	\$2,435	\$2,691	\$3,203	\$2,560	10%	15%
30x96	\$999	\$1,950	N/A	N/A	N/A	N/A	\$2,779	\$3,071	\$3,656	\$2,925	10%	15%
30x120 (1 piece)	N/A	N/A	N/A	N/A	N/A	N/A	\$3,474	\$3,839	\$4,571	\$3,656	10%	15%
30x144 (1 piece)	N/A	N/A	N/A	N/A	N/A	N/A	N/A	N/A	N/A	N/A	N/A	N/A
36x42	\$643	\$926	N/A	N/A	N/A	N/A	N/A	N/A	N/A	N/A	N/A	N/A
36x48	\$715	\$981	\$1,389	\$1,360	\$1,338	N/A	\$1,667	\$1,843	\$2,194	\$1,755	10%	15%
36x60	\$833	\$1,140	\$1,916	\$1,879	\$1,836	N/A	\$2,084	\$2,304	\$2,742	\$2,194	10%	15%
36x72	\$846	\$1,292	\$2,055	\$2,026	\$1,975	N/A	\$2,501	\$2,764	\$3,291	\$2,633	10%	15%
36x84	\$1,070	N/A	N/A	N/A	N/A	N/A	\$2,918	\$3,225	\$3,839	\$3,071	10%	15%
36x96	\$1,198	N/A	\$3,210	\$3,145	\$3,108	N/A	\$3,335	\$3,686	\$4,388	\$3,510	10%	15%
36x120 (1 piece)	N/A	N/A	N/A	N/A	N/A	N/A	\$4,168	\$4,607	\$5,485	\$4,388	10%	15%
36x144 (1 piece)	N/A	N/A	N/A	N/A	N/A	N/A	N/A	N/A	N/A	N/A	N/A	N/A
42x48	N/A	N/A	N/A	N/A	N/A	N/A	N/A	N/A	N/A	N/A	N/A	N/A
42x60	N/A	N/A	N/A	N/A	N/A	N/A	\$2,779	\$3,071	\$3,656	\$2,925	10%	15%
42x72	N/A	N/A	N/A	N/A	N/A	N/A	\$3,335	\$3,686	\$4,388	\$3,510	10%	15%
42x84	N/A	N/A	N/A	N/A	N/A	N/A	\$3,891	\$4,300	\$5,119	\$4,095	10%	15%
42x96	N/A	N/A	N/A	N/A	N/A	N/A	\$4,446	\$4,892	\$5,850	\$4,666	10%	15%
42x120 (1 piece)	N/A	N/A	N/A	N/A	N/A	N/A	\$5,558	\$6,114	\$7,313	\$5,836	10%	15%
42x144 (1 piece)	N/A	N/A	N/A	N/A	N/A	N/A	N/A	N/A	N/A	N/A	N/A	N/A
48x60	N/A	N/A	N/A	N/A	N/A	N/A	\$2,779	\$3,071	\$3,656	\$2,925	10%	15%
48x72	N/A	N/A	N/A	N/A	N/A	N/A	\$3,335	\$3,686	\$4,388	\$3,510	10%	15%
48x84	N/A	N/A	N/A	N/A	N/A	N/A	\$3,891	\$4,300	\$5,119	\$4,095	10%	15%
48x96	N/A	N/A	N/A	N/A	N/A	N/A	\$4,446	\$4,892	\$5,850	\$4,666	10%	15%
48x120 (1 piece)	N/A	N/A	N/A	N/A	N/A	N/A	\$7,313	\$7,313	\$7,313	\$7,313	10%	15%

* Urethane Comfort Edge - Pricing Reflects Ebony Color; Contact Customer Service For Other Colors: PVC On Other 3 Sides

TOP ONLY - BUTCHERBLOCK

	1-1/2" Solid Wood		1-3/4" Solid Wood	
	Red Oak	Maple	Red Oak	Solid Maple
SQUARE (SQR)				
24x24	\$444	\$528	\$461	\$595
30x30	\$693	\$825	\$720	\$930
36x36	\$998	\$1,188	\$1,037	\$1,339
42x42	\$1,774	\$2,112	\$1,843	\$2,381
48x48	\$1,774	\$2,112	\$1,843	\$2,381
60x60	\$2,772	\$3,300	\$2,880	\$3,720
ROUND (RND)				
24	\$444	\$528	\$461	\$595
30	\$693	\$825	\$720	\$930
36	\$998	\$1,188	\$1,037	\$1,339
42	\$1,358	\$1,617	\$1,411	\$1,823
48	\$1,774	\$2,112	\$1,843	\$2,381
54	\$2,245	\$2,673	\$2,333	\$3,013
60	\$2,772	\$3,300	\$2,880	\$3,720
72	\$4,435	\$5,280	\$4,608	\$5,952
RECTANGLE (REC)				
24x30	\$554	\$660	\$576	\$744
24x42	\$776	\$924	\$806	\$1,042
24x48	\$887	\$1,056	\$922	\$1,190
24x60	\$1,109	\$1,320	\$1,152	\$1,488
24x72	\$1,331	\$1,584	\$1,382	\$1,786
24x96	\$1,774	\$2,112	\$1,843	\$2,381
30x42	\$970	\$1,155	\$1,008	\$1,302
30x48	\$1,109	\$1,320	\$1,152	\$1,488
30x60	\$1,386	\$1,650	\$1,440	\$1,860
30x72	\$1,663	\$1,980	\$1,728	\$2,232
30x96	\$2,218	\$2,640	\$2,304	\$2,976
36x48	\$1,331	\$1,584	\$1,382	\$1,786
36x60	\$1,663	\$1,980	\$1,728	\$2,232
36x72	\$1,996	\$2,376	\$2,074	\$2,678

**Volume discounts available -
please contact Customer
Service for a quote.**

TOP ONLY - SOLID SURFACE

PRICING

All pricing will be quoted by Customer Service. Volume discounts are available.

AVAILABLE BRANDS

Avonite, Corian, Fenix, Formica Everform, LG Hi-Macs, Richelieu Meganite, & Wilsonart
Other brands can be custom quoted.

TABLE OPTIONS



GLIDE & CASTER SPECIFICATIONS



Standard Stainless Steel Glide

1" diameter with ¼"-20 stem. Base of glide is stainless steel over plastic. Moves easily over flooring and carpet. Not available on iQ Plus or Telesto.



iQ Plus Glide

2" diameter glide with brushed stainless steel cover over black ABS plastic foot. The stem is 15mm long to provide adjustability for uneven floors and works well for either carpet or flooring. Only available on iQ Plus, Telesto, AnyWay, and Mobi.



Equalizer Glide

This table glide is designed to automatically adjust itself in height thereby eliminating table wobble due to uneven flooring. This glide is made of high impact thermoplastic. It features an internal steel spring as well as a ¼"-20x1/2" stem. Raises height of base by approximately ¼". Not available on: AnyWay; iQ Plus; Discus; Mobi; Telesto; Titan.



Deluxe Casters

65mm Black/Grey twin wheel locking caster. Stem size is 10mm. When ordering, specify overall height of pedestal.

OPTIONS – GROMMETS

Berco offers 2 standard types of grommets. Please specify rectangular (GRR) or round (GRD). Rectangular grommets are 1-5/8" x 3-1/2" I.D. in black. Round grommets are 2-3/8" I.D. in black.

Berco offers 4 standard grommet locations. For other locations, please include a sketch or drawing.

GRR1 or GRD1 – 1 grommet in enter of table:



GRR2 or GRD2 – 1 grommet at back of table in center:



GRR3 or GRD3 – 2 grommets at back of table:

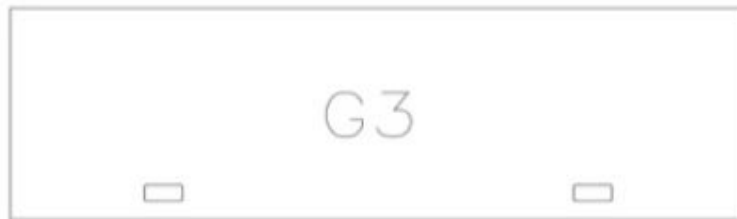

GRR4 or GRD4 – 3 grommets at the back of the table:

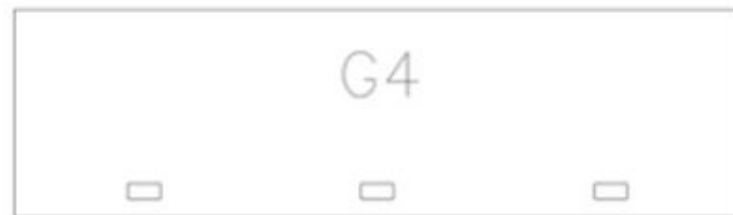

OPTIONS – TABLE LOCKS

Berco Table Locks Type "A" joins two tables together temporarily. Please provide table layout drawing or refer to table configurations below. Refer to field installation drawing below. Berco will not be responsible for field installed applications. Note: Table Locks "A" not available on 18"x48" and 18"x60" folding tables.

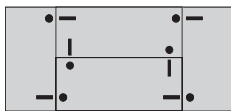
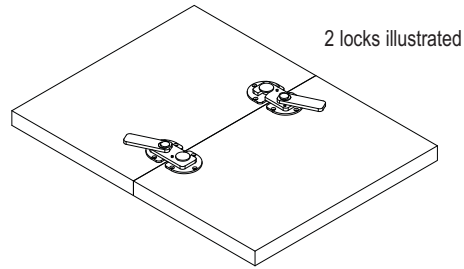

Configuration #1



Configuration #2

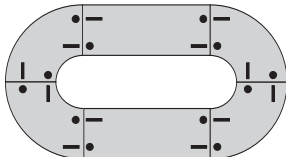

Configuration #3

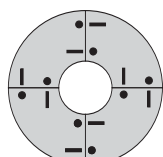

Configuration #4

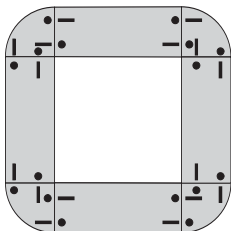

Configuration #5

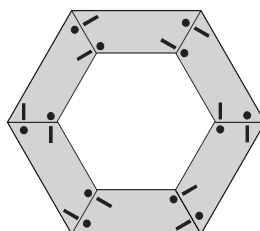

Configuration #6

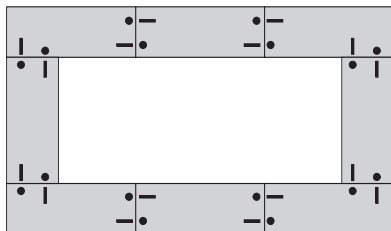

Configuration #7

TABLE LOCK "A" FIELD INSTALLATION INSTRUCTIONS

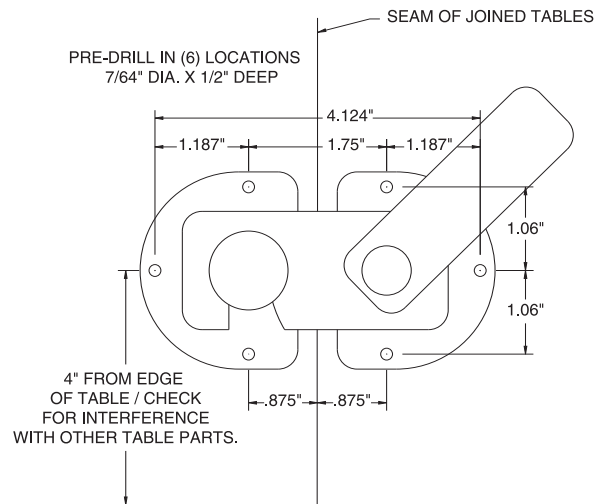

**NOTE: Drawing not to scale.
Not to be used as a template.**

TABLE OPTIONS

OPTIONS		LIST PRICE
DELUXE CASTERS (CST) - BLACK		
Per End Base		\$81
Per X Base		\$163
EQUALIZER GLIDES (EQG)		
Per End Base		\$30
Per X Base		\$61
Not available on iQ Plus or AnyWay		
FOLDING - Per End Base (FLD)		
Sense		\$212
Voyager		\$212
AnyWay		\$212
Telesto		\$200
Titan (per leg)		\$212
iQ Plus		\$200
NESTING (NST)		
Under 84" Long		\$389
Over 84" Long		\$389
FLIP TOP (FPT)		
Per X Base		\$112
iQ Plus Double & Bridge		\$315
OFFSET BASE (OFF) - Stationary Only		
OFF1	Voyager/Voyager Prem. Solid Ste	\$134
OFF2	AnyWay	\$134
24" - 30" width tables only		
ANGLE BASE (ANG)		
ANG1	Voyager	\$34
ANG2	AnyWay	\$34
SINGLE POINT RELEASE (SPR)		
Single Point Release		\$884
ADJUSTABLE HEIGHT PIN (ADJP)		
Voyager/Voyager Prem. Solid Ste		\$711
AnyWay		\$711
Excalibur		\$711
Range: 9 inches		
ADJUSTABLE HEIGHT CRANK (ADJC)		
CONSULT FACTORY FOR AVAILABILITY AND PRICING		
SPECIAL HEIGHT (SPH)		
Cross Base/Base Only		\$80
Single Column Table		\$133
Double Column Table		\$228
TABLE STIFFNER (STIFF)		
Table Stiffener		\$116
GROMMETS		
GRD1 & GRR1		\$33
GRD2 & GRR2		\$33
GRD3 & GRR3		\$54
GRD4 & GRR4		\$74

TABLE OPTIONS

OPTIONS	
	LIST PRICE
TABLE LOCKS (Each)	
Installed - TLA-I	\$57
Hardware Only - TLA-H	\$17
METAL INSERTS (Stationary Only)	
Square/Round Table	\$13
Rectangular Table	\$27
X-BASE CENTER ELECTRICAL COLUMN	
Voyager, Starfire, Excalibur, CMS AnyWay, Discus	\$338
CMSC Discus - Concealed Under Base	\$541
SPIDERS	
Corner Spider (each)	\$27
End Spider (each)	\$27
RADIUS CORNERS - P12 - 2"	
Radius Corners - Table	\$325
CUT TOP & ADD "C" LOCKS	
Up to 36" Wide - 2 locks	\$528
37" - 48" Wide - 3 locks	\$799
49" - 60" Wide - 4 locks	\$1,070
61"+ Wide - 5 locks	\$1,341
DROP LEAF	
CONTACT FACTORY FOR PRICING & OPTIONS	

MODESTY PANEL SPECIFICATIONS

Berco offers a variety of Modesty Panel options depending on your design, layout, and budget requirements.

Removable (MPR) – This modesty panel is constructed of 3/8" particleboard with laminate on front and back and a pvc edge. It is attached to the table top using a metal hanger that is riveted into the modesty panel and then mechanically hooks onto a u shaped bracket under the table top. There is a sliding access point on the metal hanger that allows you to remove the modesty from the table top whenever you desire.

Fabric (MPF) – Designed with a combination of mesh and fabric, this modesty is designed to give the tables a lighter looking scale along with introducing a different material (fabric) for your space. The construction is of two steel rods on the top and bottom of the modesty (makes them hang straight without wrinkles) with the fabric and mesh sewn onto these rods. There are Velcro fasteners on the backside of the modesty that allow you to open it up and run cables through the modesty. This is the only modesty panel option that can be used on the Mobi nesting tables (due to the curve of the Mobi leg).

Slim (MPS) – Offered as our starting price point modesty panel, our slim modesty is comprised of a thin hardboard material that is laminated on the front and back and attached to the tables using small plastic hinges that allow the modesty to hang straight, but also allow it to swing out of the way if kicked or bumped.

Metal (MMP) – This modesty panel is made of metal and offered in any of our 40+ powder coat finishes, it attaches directly to the underside of the table top for a rigid connection, because of this connection you cannot use the metal modesty on nesting style tables.

Metal Channel (MMC) – Used in conjunction with the Metal Modesty panel, this unit attaches with the Metal Modesty under the table top and allows a channel for wire management.

Acrylic (MPA) – Designed to give your space some interest and color, this modesty is made of 100% Acrylic Resin, that is a tough and durable material that is resistant to scratching and staining. It attaches to the underside of the table top using small plastic hinges that allow it to hang straight but it can swing if bumped. In addition to offering this modesty in 7 standard colors, you can choose any Benjamin Moore paint color for these modesty panels at no additional charge. The Economy Frosted Modesty is constructed of a lighter weight plastic material that is durable, but only available in a clear frosted version.

Integrated Metal (MPI) – This metal modesty combines a built in U channel with a modesty to allow wire management that is built into the modesty. Offered in our 40+ powder coat finishes, it also attached directly to the underside of the table top for a rigid connection and therefore cannot be used with nesting style tables.

MODESTY PANEL SPECIFICATIONS

Removable Modesty



<u>Smart Code</u>	<u>Size</u>
MPR848	8"x48"
MPR860	8"x60"
MPR872	8"x72"
MPR884	8"x84"
MPR896	8"x96"

Slim Modesty



<u>Smart Code</u>	<u>Size</u>
MPS842	8"x42"
MPS848	8"x48"
MPS860	8"x60"
MPS872	8"x72"
MPS884	8"x84"
MPS896	8"x96"

Fabric Modesty



<u>Smart Code</u>	<u>Size</u>	<u>Smart Code</u>	<u>Size</u>
MPF1030	10"x30"	MPF1066	10"x66"
MPF1036	10"x36"	MPF1072	10"x72"
MPF1042	10"x42"	MPF1078	10"x78"
MPF1048	10"x48"	MPF1084	10"x84"
MPF1054	10"x54"	MPF1090	10"x90"
MPF1060	10"x60"	MPF1096	10"x96"

Metal Modesty



<u>Smart Code</u>	<u>Size</u>
MMP836	8"x36"
MMP842	8"x42"
MMP848	8"x48"
MMP860	8"x60"
MMP872	8"x72"

Metal Channel



<u>Smart Code</u>	<u>Size</u>
MMC48	48"
MMC60	60"
MMC72	72"

MODESTY PANEL SPECIFICATIONS

Acrylic Modesty



Smart Code

Size

MPA48EFR (economy)	48"
MPA60EFR (economy)	60"
MPA72EFR (economy)	72"
MPA48CL	48"
MPA60CL	60"
MPA72CL	72"
MPA84CL	84"
MPA96CL	96"

Integrated Metal Modesty







Smart Code

Size

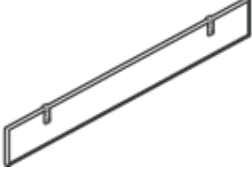
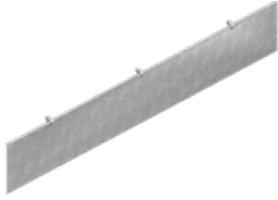
MPI48	48"
MPI60	60"
MPI72	72"

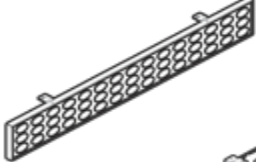
MODESTY PANELS

MODESTY PANELS			
	LIST PRICE		NESTING COMPATIBLE
REMOVABLE MODESTY PANEL (MPR)			
8" x 48"	\$221		YES
8" x 60"	\$282		YES
8" x 72"	\$282		YES
8" x 84"	\$302		YES
8" x 96"	\$302		YES
FABRIC MODESTY PANEL (MPF)			
10" x 30"	\$335		YES
10" x 36"	\$335		YES
10" x 42"	\$335		YES
10" x 48"	\$384		YES
10" x 54"	\$384		YES
10" x 60"	\$384		YES
10" x 66"	\$384		YES
10" x 72"	\$427		YES
10" x 78"	\$427		YES
10" x 84"	\$427		YES
10" x 90"	\$427		YES
10" x 96"	\$427		YES
SLIM MODESTY PANEL (MPS)			
8" x 42"	\$114		YES
8" x 48"	\$114		YES
8" x 60"	\$168		YES
8" x 72"	\$168		YES
8" x 84"	\$168		YES
8" x 96"	\$168		YES
METAL MODESTY PANEL (MMP)			
8" x 36"	\$273		NO
8" x 42"	\$273		NO
8" x 48"	\$273		NO
8" x 60"	\$273		NO
8" x 72"	\$273		NO
METAL CHANNEL (MMC)			
48"	\$101		NO
60"	\$127		NO
72"	\$174		NO

For Veneer please contact factory.

MODESTY PANELS

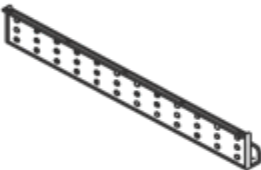
MODESTY PANELS			
	LIST PRICE		NESTING COMPATIBLE
ACRYLIC MODESTY PANEL (MPA)			
48" Economy Frosted	\$154		YES
60" Economy Frosted	\$268		YES
72" Economy Frosted	\$268		YES
48" Premium	\$646		YES
60" Premium	\$750		YES
72" Premium	\$817		YES
84" Premium	\$853		YES
96" Premium	\$890		YES
INTEGRATED METAL MODESTY (MPI)			
48"	\$275		NO
60"	\$308		NO
72"	\$355		NO

ELECTRICAL SPECIFICATIONS

With plenty of options to choose from, whether you are connecting training tables or just need a conference table with some outlets on top, we have your solution. Don't see exactly what you are looking for, call us, we will find your solution.

Villa Connectable Table Kits: This system with the "No Particular Order" wiring allows you to configure your tables in any order and connect them with a simple male to female connector and are ordered in kits that match your table top size. This unit can come with either 2 outlets only or 2 outlets and 2 data ports and either a silver or black metal grommet cover, and can be either a single circuit with standard plug in or hardwire for a 2 circuit capability. Dimension of grommet is 3" x 5 ¼".

Villa Corded Units: Available with your choice of 36", 72", or 108" cord length and either a silver or black metal grommet cover. Dimension of grommet is 3" x 5 ¼".

Miniport: This is a power data unit that has 2 power outlets and 2 data outlets with a 72" cord length and is standard in a black plastic (other colors are available). Dimension of unit is 3" x 7".

Interport: Designed to accommodate those extra cords from your laptop by having a secondary lid that you open and place all your excess cords into the opening and letting them drop down below the table top. It also comes with 2 power outlets and 2 data outlets with a 72" cord length and is standard in a black plastic. Dimension of unit is 5" x 7".

Power/Data Sphere: Contains 2 power outlets and 2 data outlets with a 72" cord length and is standard in a black plastic. Dimension of unit is 3 ½" diameter.

MHO: Contains 2 power outlets and 2 data outlets with a 72" cord length and is standard with an aluminum grommet. Dimension of unit is 4 7/16" x 8 5/8".

Powernet Electrical and Modesty

Designed to accommodate training tables that require substantial electrical and data capacity, along with ease of access, the Powernet system can be utilized on almost any table series from Berco.

Specifications: Constructed of extruded aluminum the Powernet Modesty is 8 ¼" tall and matches the length of the table top. The Channel version has an extruded aluminum channel that is 3" tall by 3 ¼' deep to accommodate large amounts of electrical and data. The Powernet Raceway includes a fully enclosed steel box that contains all necessary electrical and data along with a hinged door to allow easy access for wiring or plugging in technology.

Finishes: Modesty panel available in over 40+ powder coat finishes

Electrical: Designed to handle any intense electrification needs, the powernet electrical system is an 8 wire, 4 circuit system. You can choose to configure it as a simple 15 AMP single circuit with a conventional plug to power up, a 20 AMP specialized plug in, or a hardwire infeed that can utilize up to all four separate circuits.

VILLA ELECTRICAL SPECIFICATIONS

VILLA ELECTRICAL SYSTEM - SPECIFICATIONS/PRICING

Single Circuit

- Provides maximum flexibility for rooms with limited electrical needs (i.e. Small Work Area, Conference Room, etc.)
- A maximum of 6 electrical units can be linked on 1 circuit grid

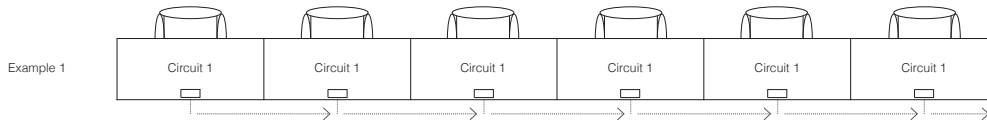

Double Circuit

- Used in rooms with greater electrical needs (i.e. Class Room, Training Room, etc.)
- A maximum of 12 electrical units can be linked on 1 double circuit in feed
- Using a Double Circuit requires the circuits to be assigned to alternating tables, as shown:

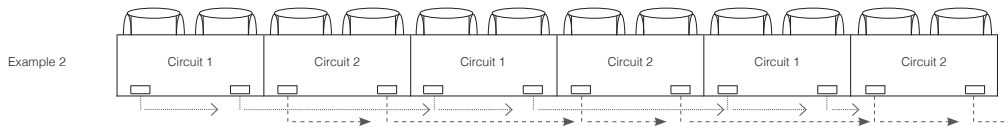

The “No Particular Order” Electrical System

Villa's non-directional, non-sequential electrical package allows nearly any table layout you desire. The order of the tables is not limited by single or double circuit. Tables may be reconfigured by simply disconnecting from the power source and reconnecting in a new configuration.

Non-Directional - Wall or floor power in-feed cables can be attached to either end of the table configuration.

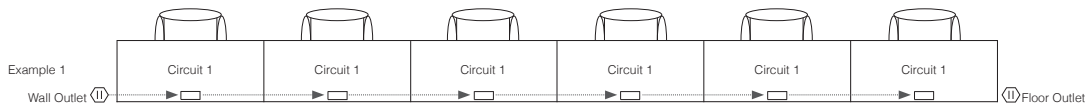

Non-Sequential - Table order isn't a concern with Villa's electrical system.

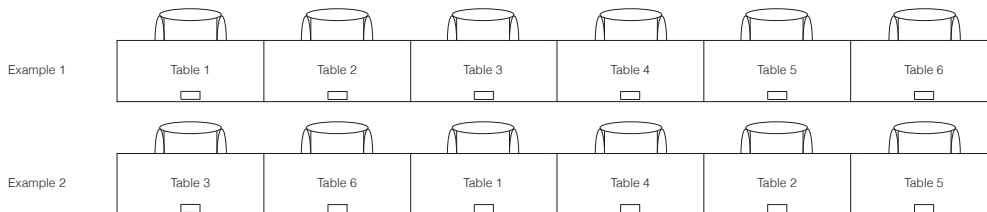

Single and Double Circuit Options

- Quick disconnect wall outlet
- Hard wiring from wall
- Power source from the building must be wired for 2 circuits to handle a double circuit option

Double Circuit

- The electrical system is a four wire system consisting of two individual circuits. Each circuit is rated at 20 amps/120 volts maximum. Circuit 1 (black), and Circuit 2 (red) are served by a system neutral (white) and an equipment ground (green). Please check with local codes before connecting to building.

ELECTRICAL SPECIFICATIONS

<u>Villa Connectable Kits</u>	<u>Smart Code</u>	<u>Length</u>	<u>Power/Data</u>	<u>Color</u>
	PV361-P	36"	Power Only – Single	Black (B) or Silver (S)
	PV421-P	42"	Power Only – Single	Black (B) or Silver (S)
	PV481-P	48"	Power Only – Single	Black (B) or Silver (S)
	PV601-P	60"	Power Only – Single	Black (B) or Silver (S)
	PV721-P	72"	Power Only - Single	Black (B) or Silver (S)
	PV361-PD	36"	Power & Data – Single	Black (B) or Silver (S)
	PV421-PD	42"	Power & Data – Single	Black (B) or Silver (S)
	PV481-PD	48"	Power & Data – Single	Black (B) or Silver (S)
	PV601-PD	60"	Power & Data – Single	Black (B) or Silver (S)
	PV721-PD	72"	Power & Data – Single	Black (B) or Silver (S)
	PV841-P	84"	Power Only – Single	Black (B) or Silver (S)
	PV961-P	96"	Power Only – Single	Black (B) or Silver (S)
	PV841-PD	84"	Power & Data – Single	Black (B) or Silver (S)
	PV961-PD	96"	Power & Data – Single	Black (B) or Silver (S)
	PV602-P	60"	Power Only – Double	Black (B) or Silver (S)
	PV722-P	72"	Power Only – Double	Black (B) or Silver (S)
	PV602-PD	60"	Power & Data – Double	Black (B) or Silver (S)
	PV722-PD	72"	Power & Data - Double	Black (B) or Silver (S)
	PV842-P	84"	Power Only – Double	Black (B) or Silver (S)
	PV962-P	96"	Power Only – Double	Black (B) or Silver (S)
	PV842-PD	84"	Power & Data – Double	Black (B) or Silver (S)
	PV962-PD	96"	Power & Data - Double	Black (B) or Silver (S)

ELECTRICAL SPECIFICATIONS

<u>Villa Power In-Feeds</u>	<u>Smart Code</u>
15amp Plug In Circuit	Vi
Hardwired	ViH

<u>Villa Corded Units</u>	<u>Smart Code</u>	<u>Length</u>	<u>Power/Data</u>	<u>Color</u>
	PVC36-P	36"	Power Only	Black (B) or Silver (S)
	PVC72-P	72"	Power Only	Black (B) or Silver (S)
	PVC108-P	108"	Power Only	Black (B) or Silver (S)
	PVC36-PD	36"	Power & Data	Black (B) or Silver (S)
	PVC72-PD	72"	Power & Data	Black (B) or Silver (S)
	PVC108-PD	108"	Power & Data	Black (B) or Silver (S)

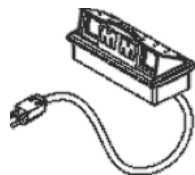
<u>Mini-Port</u>	<u>Smart Code</u>	<u>Length</u>	<u>Power/Data</u>	<u>Color</u>
	MIS	6'	2 Power / 2 Data	Black

<u>Inter-Port</u>	<u>Smart Code</u>	<u>Length</u>	<u>Power/Data</u>	<u>Color</u>
	INS	6'	2 Power / 2 Data	Black

ELECTRICAL SPECIFICATIONS

Power Data Sphere

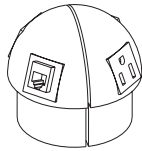

Smart Code

PDS

Length

6'

Power/Data

2 Power / 2 Data

Color

Black

MHO

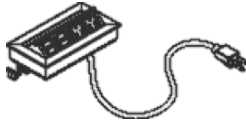

Smart Code

MHO

Length

6'

Power/Data

2 Power / 2 Data

Color

Aluminum

POWERNET SPECIFICATIONS

PowerNet tables with PowerNet Electrification

PowerNet tables are available with an 8-wire distribution system with up to four 20 amp circuits in a hardwire system or 15 amp or 20 amp single circuit systems. The hardwire system is supplied with an orange receptacle that is a dedicated circuit with its own neutral and ground wire. The single circuit systems work with standard 15 or 20 amp receptacles.

The wiring system has eight conductors. Three of the conductors — circuit wire, neutral wire, and an isolated ground wire — are shielded and dedicated for computer use. The other five conductors are three circuits with a shared neutral and equipment ground for convenience receptacles. All conductors are No. 12 A.W.G. except the shared neutral, which is No. 10 A.W.G.

15 Amp Power Modules

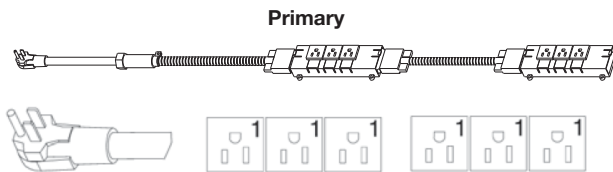

15 amp **primary** single circuit power feed for 60", 72", 84" and 96" tables.

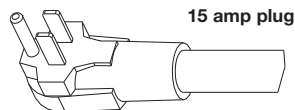
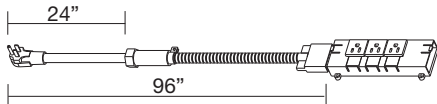

15 amp **primary** single circuit power feed for 48" tables. Our 48" tables have 3 electrical receptacles to service one workstation.

Power jumper modules consist of the same wiring as the in-feed, provide power for multi table configurations, and are easily connected and disconnected. Generous lengths of jumpers are provided to maximize configuration flexibility.

Berco recommends consulting a licensed electrician for circuit requirements.



15 amp power jumper module for **secondary** tables.

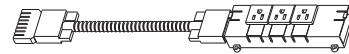

15 amp power jumper module for 48" **secondary** tables. Our 48" tables have 3 electrical receptacles to service one workstation.

20 Amp Power Modules

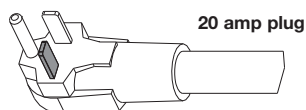

Note the special orientation of the 20 amp plug.

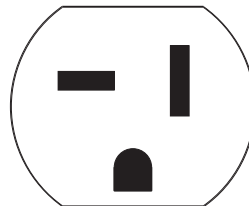

20 amp receptacle

POWERNET SPECIFICATIONS

PowerNet 20 Amp Hardwire Power Modules

PowerNet 20 amp hardwire systems feature modular snap-in receptacles. The modules can be arranged in numerous configurations to fit specific requirements. **Berco recommends consulting a licensed electrician for circuit requirements.**

Specifying a 20 Amp Hardwire System

This is an example of how a 20 amp hardwire system may be configured. Circuit receptacles 1-4 may be put in any position. All receptacles snap in and out for ease of configuration.



20 amp hardwire power feed. 48" tables have 3 electrical receptacles to service one workstation.



20 amp hardwire power jumper. 48" tables have 3 electrical receptacles to service one workstation.

Please specify Primary or Secondary.

Example: Receptacle

Position 1	<u>1</u>
Position 2	<u>2</u>
Position 3	<u>3IG</u>
Position 4	<u>4</u>
Position 5	<u>1</u>
Position 6	<u>3IG</u>

20 Amp Receptacle Module A

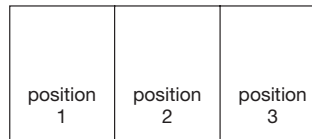

20 Amp Receptacle Module B

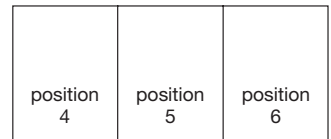

Receptacle #1



Receptacle #2



Receptacle #3
Isolated Ground



Receptacle #4

PowerNet Data Communication Options – *Please specify one*

PowerNet tables can be ordered with data communication receptacles. We offer five different brands shown at right. The diagrams indicate the number and type of receptacles. The combination of RJ11 and RJ45 receptacles may be changed to meet your requirements. All RJ45 receptacles are CAT 5e rated.

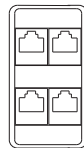

Panduit

D1
Panduit
2 – RJ11
2 – RJ45

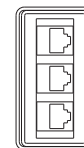

Hubbel

D2
Hubbel
2 – RJ11
1 – RJ45

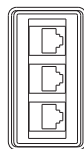

Amp

D4
Amp
1 – RJ11
2 – RJ45

D3
Avaya
1 – RJ11
2 – RJ45

Avaya

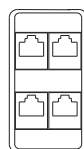

Siemon

D5
Siemon
2 – RJ11
2 – RJ45

D6
Other Manufacturers
available. Call Customer
Service for availability
and pricing.

POWERNET SPECIFICATIONS

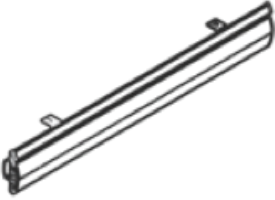
<u>PowerNet Channel</u>	<u>Smart Code</u>	<u>Length</u>	<u>Power/Data</u>
	IQPC-48	48"	None
	IQPC-60	60"	None
	IQPC-72	72"	None
	IQPC-84	84"	None
	IQPC-96	96"	None

POWERNET SPECIFICATIONS

PowerNet Raceway

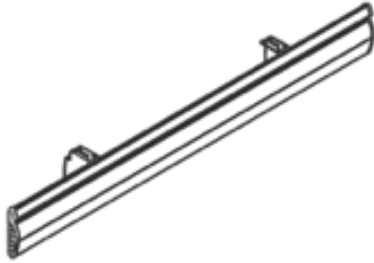

<u>Smart Code</u>	<u>Length</u>	<u>Power/Data</u>
IQPR-48	48"	None
IQPR-60	60"	None
IQPR-72	72"	None
IQPR-84	84"	None
IQPR-96	96"	None
IQPR-48-PDC44	48"	Data Only – 2 RJ45
IQPR-60-PDC4444	60"	Data Only – 4 RJ45
IQPR-72-PDC4444	72"	Data Only – 4 RJ45
IQPR-84-PDC4444	84"	Data Only – 4 RJ45
IQPR-96-PDC4444	96"	Data Only – 4 RJ45
IQPR-48-PR1	48"	3 outlet - Single – PRIMARY Electrical Pack
IQPR-48-PR2	48"	3 outlet – Single – CONNECTOR Electrical Pack
IQPR-48-PR1-PDC44	48"	Power & Data – Single – PRIMARY Electrical Pack
IQPR-48-PR2-PDC44	48"	Power & Data – Single – CONNECTOR Electrical Pack
IQPR-60-PR1	60"	3 outlet – Double – PRIMARY Electrical Pack
IQPR-60-PR2	60"	3 outlet – Double – CONNECTOR Electrical Pack
IQPR-60-PR1-PDC4444	60"	Power & Data – Double – PRIMARY Electrical Pack
IQPR-60-PR2-PDC4444	60"	Power & Data – Double – CONNECTOR Electrical Pack
IQPR-72-PR1	72"	3 outlet – Double – PRIMARY Electrical Pack
IQPR-72-PR2	72"	3 outlet – CONNECTOR Electrical Pack
IQPR-72-PR1-PDC4444	72"	Power & Data – PRIMARY Electrical Pack
IQPR-72-PR2-PDC4444	72"	Power & Data – CONNECTOR Electrical Pack

POWERNET SPECIFICATIONS

PowerNet Raceway

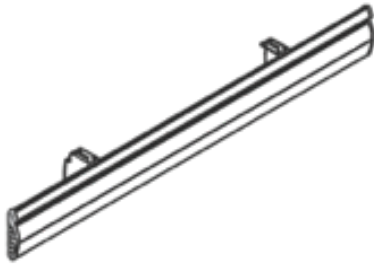

Smart Code

Length

Power/Data

IQPR-84-PR1	84"	3 outlet – Double – PRIMARY Electrical Pack
IQPR-84-PR2	84"	3 outlet – Double – CONNECTOR Electrical Pack
IQPR-84-PR1-PDC4444	84"	Power & Data – Double – PRIMARY Electrical Pack
IQPR-84-PR2-PDC4444	84"	Power & Data – Double – CONNECTOR Electrical Pack
IQPR-96-PR1	96"	3 outlet – Double – PRIMARY Electrical Pack
IQPR-96-PR2	96"	3 outlet – CONNECTOR Electrical Pack
IQPR-96-PR1-PDC4444	96"	Power & Data – PRIMARY Electrical Pack
IQPR-96-PR2-PDC4444	96"	Power & Data – CONNECTOR Electrical Pack

ELECTRIFICATION

		LIST PRICE
WIRE MGT. CHANNEL (WMC)		
WMC-4	48" table	\$88
WMC-5	60" table	\$95
WMC-6	72" table	\$122
WMC-7	84" table	\$135
WMC-8	96" table	\$142
VERTICAL 18" COLUMNWAY (CW)		
CW-1	1-1/4"	\$156
CW-2	2"	\$156
VILLA ELECTRICAL (Connectable Table Kits)		
PV361-P	36" Power Only - Single - White, Black or Silver	\$561
PV421-P	42" Power Only - Single - White, Black or Silver	\$561
PV481-P	48" Power Only - Single - White, Black or Silver	\$561
PV601-P	60" Power Only - Single - White, Black or Silver	\$561
PV721-P	72" Power Only - Single - White, Black or Silver	\$561
PV841-P	84" Power Only - Single - White, Black or Silver	\$701
PV961-P	96" Power Only - Single - White, Black or Silver	\$701
PV361-PD	36" Power & Data - Single - White, Black or Silver	\$616
PV421-PD	42" Power & Data - Single - White, Black or Silver	\$616
PV481-PD	48" Power & Data - Single - White, Black or Silver	\$616
PV601-PD	60" Power & Data - Single - White, Black or Silver	\$616
PV721-PD	72" Power & Data - Single - White, Black or Silver	\$616
PV841-PD	84" Power & Data - Single - White, Black or Silver	\$756
PV961-PD	96" Power & Data - Single - White, Black or Silver	\$756
PV602-P	60" Power Only - Double - White, Black or Silver	\$914
PV722-P	72" Power Only - Double - White, Black or Silver	\$914
PV842-P	84" Power Only - Double - White, Black or Silver	\$1,152
PV962-P	96" Power Only - Double - White, Black or Silver	\$1,152
PV602-PD	60" Power & Data - Double - White, Black or Silver	\$1,018
PV722-PD	72" Power & Data - Double - White, Black or Silver	\$1,018
PV842-PD	84" Power & Data - Double - White, Black or Silver	\$1,255
PV962-PD	96" Power & Data - Double - White, Black or Silver	\$1,255
PV361-2P2U	36" - 2 POWER AND 2 USB, SINGLE KIT - White, Black or Silver	\$737
PV421-2P2U	42" - 2 POWER AND 2 USB, SINGLE KIT - White, Black or Silver	\$737
PV481-2P2U	48" - 2 POWER AND 2 USB, SINGLE KIT - White, Black or Silver	\$737
PV601-2P2U	60" - 2 POWER AND 2 USB, SINGLE KIT - White, Black or Silver	\$737
PV721-2P2U	72" - 2 POWER AND 2 USB, SINGLE KIT - White, Black or Silver	\$737
PV602-2P2U	60" - 2 POWER AND 2 USB, DOUBLE KIT - White, Black or Silver	\$1,408
PV722-2P2U	72" - 2 POWER AND 2 USB, DOUBLE KIT - White, Black or Silver	\$1,408
PV842-2P2U	84" - 2 POWER AND 2 USB, DOUBLE KIT - White, Black or Silver	\$1,408
PV962-2P2U	96" - 2 POWER AND 2 USB, DOUBLE KIT - White, Black or Silver	\$1,408



ELECTRIFICATION

		LIST PRICE
VILLA II CONNECTABLE KITS - 2 POWER ON TOP & 2 POWER BELOW		
PV361-P4	36" - 4 POWER ONLY, SINGLE KIT - White, Black or	\$637
PV421-P4	42" - 4 POWER ONLY, SINGLE KIT - White, Black or	\$637
PV481-P4	48" - 4 POWER ONLY, SINGLE KIT - White, Black or	\$637
PV601-P4	60" - 4 POWER ONLY, SINGLE KIT - White, Black or	\$637
PV721-P4	72" - 4 POWER ONLY, SINGLE KIT - White, Black or	\$637
PV602-P4	60" - 4 POWER ONLY, DOUBLE KIT - White, Black o	\$1,207
PV722-P4	72" - 4 POWER ONLY, DOUBLE KIT - White, Black o	\$1,207
PV842-P4	84" - 4 POWER ONLY, DOUBLE KIT - White, Black o	\$1,207
PV962-P4	96" - 4 POWER ONLY, DOUBLE KIT - White, Black o	\$1,207
VILLA II CONNECTABLE KITS - 2 POWER ON TOP & 2 POWER BELOW WITH WIRELESS CHARGING		
PV361-P4W1	36" POWER ONLY, SINGLE KIT - Black or Silver	\$1,823
PV421-P4W1	42" POWER ONLY, SINGLE KIT - Black or Silver	\$1,823
PV481-P4W1	48" POWER ONLY, SINGLE KIT - Black or Silver	\$1,823
PV601-P4W1	60" POWER ONLY, SINGLE KIT - Black or Silver	\$1,823
PV721-P4W1	72" POWER ONLY, SINGLE KIT - Black or Silver	\$1,823
VILLA ELECTRICAL (Power In-Feeds)		
Vi	15amp Plug In Single Circuit	\$274
ViH	Hardwired	\$183
Daisy-T	Daisy T	\$202
VILLA CORDED		
PVC36-P	36" Power Only - Black or Silver	\$308
PVC72-P	72" Power Only - Black or Silver	\$308
PVC108-P	108" Power Only - Black or Silver	\$308
PVC36-PD	36" Power & Data - Black or Silver	\$369
PVC72-PD	72" Power & Data - Black or Silver	\$369
PVC108-PD	108" Power & Data - Black or Silver	\$369



ELECTRIFICATION

		LIST PRICE
MINI-PORT (MIS)		
MIS	6' Cord - Black Plastic - 2 Power & 2 Data	\$389
INTER-PORT (INS)		
INS	6' Cord - Black Plastic - 2 Power & 2 Data	\$362
POWER DATA SPHERE (PDS)		
PDS	2 Power / 2 Data - Black Plastic	\$369
MHO (MHS)		
MHO	6' Cord - Aluminum color - 2 Power & 2 Data	\$684
POWER NET CHANNEL (no chrome)		
	IQPC-48	\$494
	IQPC-60	\$555
	IQPC-72	\$579
	IQPC-84	\$701
	IQPC-96	\$725

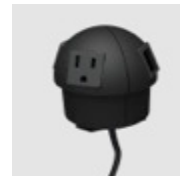

ELECTRIFICATION

		LIST PRICE
POWER NET RACEWAY (no chrome or nesting)		
IQPR-48	48" - No Power or Data	\$585
IQPR-60	60" - No Power or Data	\$676
IQPR-72	72" - No Power or Data	\$701
IQPR-84	84" - No Power or Data	\$975
IQPR-96	96" - No Power or Data	\$738
IQPR-48-PDC44	48" - Data Only - 2 RJ45	\$701
IQPR-48-PR1	48" - Power Only - Single - 3 Outlet - PRIMARY Electrical	\$1,243
IQPR-48-PR2	48" - Power Only - Single - 3 Outlet - CONNECTOR	\$1,243
IQPR-48-PR1-PDC44	48" - Power & Data - Single - PRIMARY Electrical Pa	\$1,359
IQPR-48-PR2-PDC44	48" - Power & Data - Single - CONNECTOR Electric	\$1,359
IQPR-60-PDC44	60" - Data Only - 2 RJ45	\$865
IQPR-60-PR1	60" - Power Only - Double - 3 outlet - PRIMARY Elec	\$1,578
IQPR-60-PR2	60" - Power Only - Double - 3 outlet - CONNECTOR	\$1,578
IQPR-60-PR1-PDC44	60" - Power & Data - Double - PRIMARY Electrical Pa	\$1,767
IQPR-60-PR2-PDC44	60" - Power & Data - Double - CONNECTOR Electric	\$1,767
IQPR-72-PDC44	72" - Data Only - 2 RJ45	\$890
IQPR-72-PR1	72" - Power Only - Double - 3 Outlet - PRIMARY Elec	\$1,603
IQPR-72-PR2	72" - Power Only - Double - 3 Outlet - CONNECTOR	\$1,603
IQPR-72-PR1-PDC44	72" - Power & Data - Double - PRIMARY Electrical Pa	\$1,792
IQPR-72-PR2-PDC44	72" - Power & Data - Double - CONNECTOR Electric	\$1,792
IQPR-84-PDC44	84" - Data Only - 2 RJ45	\$1,164
IQPR-84-PR1	84" - Power Only - Double - 3 Outlet - PRIMARY Elec	\$1,877
IQPR-84-PR2	84" - Power Only - Double - 3 Outlet - CONNECTOR	\$1,877
IQPR-84-PR1-PDC44	84" - Power & Data - Double - PRIMARY Electrical Pa	\$2,066
IQPR-84-PR2-PDC44	84" - Power & Data - Double - CONNECTOR Electric	\$2,066
IQPR-96-PDC44	96" - Data Only - 2 RJ45	\$1,188
IQPR-96-PR1	96" - Power Only - Double - 3 Outlet - PRIMARY Elec	\$1,901
IQPR-96-PR2	96" - Power Only - Double - 3 Outlet - CONNECTOR	\$1,901
IQPR-96-PR1-PDC44	96" - Power & Data - Double - PRIMARY Electrical Pa	\$2,090
IQPR-96-PR2-PDC44	96" - Power & Data - Double - CONNECTOR Electric	\$2,090
ELECTRIC HEIGHT ADJUSTABLE - VILLA POWER OPTIONS		
PVCC72-P	72" Cord - 2 outlets on top - 3 outlets under table top	\$386
PVCC72-PD	72" Cord - 2 outlets on top - 3 outlets under table top	\$446
NODE		
NOD72-P2	2 Outlets - 72" Cord	\$255
NOD72-P1U1	1 Outlet - 1 USB - 72" Cord	\$452
NOD72-P1D1	1 Outlet - 1 Data - 72" Cord	\$335

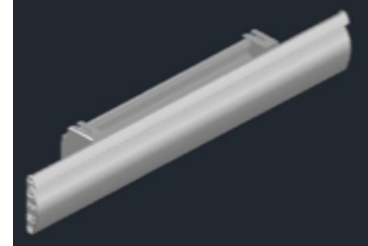

ELECTRIFICATION

		LIST PRICE
MOIRE		
MOI72-P4	4 Outlets - 72" Cord	\$410
MOI72-P3D1	3 Outlets - 1 Data - 72" Cord	\$344
MOI72-P3U1	3 Outlets - 1 USB - 72" Cord	\$468
MOI72-P2U2	2 Outlets - 2 USB - 72" Cord	\$587
MOI72-P2D1U1	2 Outlets - 1 Data - 1 USB - 72" Cord	\$455
MOI72-P2D2	2 Outlets - 2 Data - 72" Cord	\$338
MOI72-D4	4 Data - 72" Cord	\$338
COVE		
COV108-P2	2 Outlets - 108" Cord - White, Black or Silver	\$402
COV108-P2U2	2 Outlets - 2 USB - 108" Cord - White, Black or Silver	\$603
COV108-P3D1	3 Outlets - 1 Data - 108" Cord - White, Black or Silver	\$503
COV108-P4U2	4 Outlets - 2 USB - 108" Cord - White, Black or Silver	\$771
COV108-P2U2D1	4 Outlets - 2 USB - 1 Data - 108" Cord - White, Black or Silver	\$771
COV108-P6U4	6 Outlets - 4 USB - 108" Cord - White, Black or Silver	\$1,140
COV108-P2U2C2	2 Outlets - 2 USB - 2 Conv. Outlets - 108" Cord - White, Black or Silver	\$804
COV108-P2C2	2 Outlets - 2 Conv. Outlets - 108" Cord - White, Black or Silver	\$436
COVE CONNECTABLE KITS		
COV361-P2	36" - 2 POWER ONLY, SINGLE KIT - White, Black or Silver	\$603
COV421-P2	42" - 2 POWER ONLY, SINGLE KIT - White, Black or Silver	\$603
COV481-P2	48" - 2 POWER ONLY, SINGLE KIT - White, Black or Silver	\$603
COV601-P2	60" - 2 POWER ONLY, SINGLE KIT - White, Black or Silver	\$603
COV721-P2	72" - 2 POWER ONLY, SINGLE KIT - White, Black or Silver	\$603
COV602-P2	60" - 2 POWER ONLY, DOUBLE KIT - White, Black or Silver	\$1,073
COV722-P2	72" - 2 POWER ONLY, DOUBLE KIT - White, Black or Silver	\$1,073
COV842-P2	84" - 2 POWER ONLY, DOUBLE KIT - White, Black or Silver	\$1,073
COV962-P2	96" - 2 POWER ONLY, DOUBLE KIT - White, Black or Silver	\$1,073
COV361-P4	36" - 4 POWER ONLY, SINGLE KIT - White, Black or Silver	\$905
COV421-P4	42" - 4 POWER ONLY, SINGLE KIT - White, Black or Silver	\$905
COV481-P4	48" - 4 POWER ONLY, SINGLE KIT - White, Black or Silver	\$905
COV601-P4	60" - 4 POWER ONLY, SINGLE KIT - White, Black or Silver	\$905
COV721-P4	72" - 4 POWER ONLY, SINGLE KIT - White, Black or Silver	\$905
COV602-P4	60" - 4 POWER ONLY, DOUBLE KIT - White, Black or Silver	\$1,676
COV722-P4	72" - 4 POWER ONLY, DOUBLE KIT - White, Black or Silver	\$1,676
COV842-P4	84" - 4 POWER ONLY, DOUBLE KIT - White, Black or Silver	\$1,676
COV962-P4	96" - 4 POWER ONLY, DOUBLE KIT - White, Black or Silver	\$1,676
COV361-P2U2	36" - 2 POWER AND 2 USB, SINGLE KIT - White, Black or Silver	\$804
COV421-P2U2	42" - 2 POWER AND 2 USB, SINGLE KIT - White, Black or Silver	\$804
COV481-P2U2	48" - 2 POWER AND 2 USB, SINGLE KIT - White, Black or Silver	\$804
COV601-P2U2	60" - 2 POWER AND 2 USB, SINGLE KIT - White, Black or Silver	\$804
COV721-P2U2	72" - 2 POWER AND 2 USB, SINGLE KIT - White, Black or Silver	\$804
COV602-P2U2	60" - 2 POWER AND 2 USB, DOUBLE KIT - White, Black or Silver	\$1,475
COV722-P2U2	72" - 2 POWER AND 2 USB, DOUBLE KIT - White, Black or Silver	\$1,475
COV842-P2U2	84" - 2 POWER AND 2 USB, DOUBLE KIT - White, Black or Silver	\$1,475



ELECTRIFICATION

		LIST PRICE
COV962-P2U2	96" - 2 POWER AND 2 USB, DOUBLE KIT - White, Blac	\$1,475
COV361-P4U2	36" - 4 POWER AND 2 USB, SINGLE KIT - White, Blac	\$1,106
COV421-P4U2	42" - 4 POWER AND 2 USB, SINGLE KIT - White, Blac	\$1,106
COV481-P4U2	48" - 4 POWER AND 2 USB, SINGLE KIT - White, Blac	\$1,106
COV601-P4U2	60" - 4 POWER AND 2 USB, SINGLE KIT - White, Blac	\$1,106
COV721-P4U2	72" - 4 POWER AND 2 USB, SINGLE KIT - White, Blac	\$1,106
COV602-P4U2	60" - 4 POWER AND 2 USB, DOUBLE KIT - White, Blac	\$2,078
COV722-P4U2	72" - 4 POWER AND 2 USB, DOUBLE KIT - White, Blac	\$2,078
COV842-P4U2	84" - 4 POWER AND 2 USB, DOUBLE KIT - White, Blac	\$2,078
COV962-P4U2	96" - 4 POWER AND 2 USB, DOUBLE KIT - White, Blac	\$2,078

COVE ROUND SERIES - CORDED

COV-R-108-P1U2	ONE POWER, 2 USB, 108" CORD LENGTH - White,	\$570
COV-R-108-P2U2	TWO POWER, TWO USB, 108" CORD LENGTH - W	\$603
COV-R-108-P2	TWO POWER ONLY, 108" CORD LENGTH - White,	\$402



INTERACT CORDED UNIT - 2 POWER ON TOP - 1 POWER BELOW - WITH 2 DATA KNOCKOUTS AND TELECOM PLATE FOR TECHNOLOGY OPTIONS

INTG-72-T05	72" CORD BLACK TEXTURED CASE	\$488
INTG-108-T05	108" CORD BLACK TEXTURED CASE	\$539
INTG-120-T05	120" CORD BLACK TEXTURED CASE	\$651
INTG-72-M24	72" CORD SILVER CASE	\$488
INTG-108-M24	108" CORD SILVER CASE	\$539
INTG-120-M24	120" CORD SILVER CASE	\$566
INTG-72-S11	72" CORD WHITE CASE	\$488
INTG-108-S11	108" CORD WHITE CASE	\$539
INTG-120-S11	120" CORD WHITE CASE	\$566

INTERACT CORDED UNIT - 2 POWER & 2 USB ON TOP - 1 POWER BELOW - WITH 2 DATA KNOCKOUTS AND TELECOM PLATE FOR TECHNOLOGY OPTIO

INTG-72-U2-T05	72" CORD BLACK TEXTURED CASE	\$683
INTG-108-U2-T05	108" CORD BLACK TEXTURED CASE	\$734
INTG-120-U2-T05	120" CORD BLACK TEXTURED CASE	\$761
INTG-72-U2-M24	72" CORD SILVER CASE	\$683
INTG-108-U2-M24	108" CORD SILVER CASE	\$734
INTG-120-U2-M24	120" CORD SILVER CASE	\$761
INTG-72-U2-S11	72" CORD WHITE CASE	\$683
INTG-108-U2-S11	108" CORD WHITE CASE	\$734
INTG-120-U2-S11	120" CORD WHITE CASE	\$761



ELECTRIFICATION

		LIST PRICE
INTERACT - TELECOM PLATES FOR 2 POWER ON TOP UNITS		
TELECOM-A	BLANK PLATE	\$9
TELECOM-DD	TWO RJ45 CAT 6 CONNECTORS	\$176
TELECOM-DDD	THREE RJ45 CAT 6 CONNECTORS	\$260
TELECOM-DDDD	FOUR RJ45 CAT 6 CONNECTORS	\$344
TELECOM-D-VGA	ONE RJ45, ONE 15 PIN HD VGA FEMALE/FEMALE WITH 72" PATCH CORD	\$293
TELECOM-DD-VGA	TWO RJ45, ONE 15 PIN HD VGA FEMALE/FEMALE WITH 72" PATCH CORD	\$320
TELECOM-L-VGA	ONE MINI STEREO, ONE 15 PIN HD VGA FEMALE/FEMALE WITH 72" PATCH CORD	\$213
TELECOM-H-M-VGA	ONE HDMI FEMALE/FEMALE WITH 36" PATCH CORD ONE MINI STEREO, ONE 15 PIN HD VGA FEMALE/FEMALE WITH 72" PATCH CORD	\$406
TELECOM-H	ONE HDMI FEMALE/FEMALE WITH 36" PATCH CORD	\$206
TELECOM-P-D	ONE RJ11 CAT3 PHONE, TWO RJ45 CAT 6 DATA	\$224
INTERACT CORDED UNIT - 4 POWER & 4 DATA KNOCKOUTS		
INTG-72-P4-T05	72" CORD BLACK TEXTURED CASE	\$773
INTG-108-P4-T05	108" CORD BLACK TEXTURED CASE	\$825
INTG-120-P4-T-5	120" CORD BLACK TEXTURED CASE	\$852
INTG-72-P4-M24	72" CORD SILVER CASE	\$773
INTG-108-P4-M24	108" CORD SILVER CASE	\$825
INTG-120-P4-M24	120" CORD SILVER CASE	\$852
INTG-72-P4-S11	72" CORD WHITE CASE	\$773
INTG-108-P4-S11	108" CORD WHITE CASE	\$825
INTG-120-P4-S11	120" CORD WHITE CASE	\$852
TOP NOTCH CORDED UNIT		
TN2-72-P-T05	TWO POWER AND 72" CORD BLACK TEXTURED CASE	\$382
TN2-72-PD-T05	ONE POWER ONE DATA JACK 72" CORD BLACK TEXTURED CASE	\$530
TN2-72-P-M24	TWO POWER AND 72" CORD SILVER CASE	\$382
TN2-72-PD-M24	ONE POWER ONE DATA JACK 72" CORD SILVER CASE	\$530
TECH TOP		
TEC	Tech Top Charger <i>Note: For multiple daisy-chained units, contact Factory for design and pricing</i>	\$677

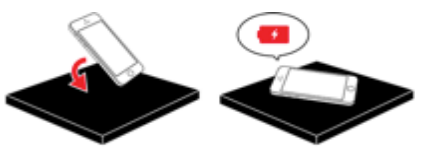

Step 1. Place Step 2. Charge

TABLE STORAGE CARTS

Vertical Carts (V) – Rectangular model stores rectangular tables up to 96" long and overlap vertically. Fits 6 folding tables stored vertically. Rectangular tables only. Round/Square model stores round tables up to 72" and square tables up to 60". Fits 6 folding tables stored vertically. Round and square tables only.

Folding Table Storage Carts – All carts are 30" wide and suitable for tables 18" to 48" wide. Please specify size of table to be stored. All carts available in black wrinkle finish only. CAUTION – Table widths over 30" may need to be stored vertically depending on available door openings.

Flat Cart (F) – Stores rectangular folding tables flat. Fits up to 8 folding tables. Rectangular tables only.

Flat Cart – Modesty Panel Storage (FMO) – Stores rectangular folding tables flat. Fits up to 8 folding tables and modesty panels. Rectangular tables only.

<u>Vertical Cart</u>	<u>Smart Code</u>	<u>Top Length</u>
	V48	48" – Rectangular
	V60	60" – Rectangular
	V72	72" – Rectangular
	V84	84" – Rectangular
	V96	96" – Rectangular
	V4854	Up to 54" – Round/Square
	V6072	Up to 72" – Round/Square

<u>Flat Cart</u>	<u>Smart Code</u>	<u>Top Length</u>
	F60	60" – Rectangular
	F72	72" – Rectangular
	F84	84" – Rectangular
	F96	96" – Rectangular

TABLE CARTS

			LIST PRICE
VERTICAL CART			
V48	48"	Rectangular Table	\$2,030
V60	60"	Rectangular Table	\$2,030
V72	72"	Rectangular Table	\$2,030
V84	84"	Rectangular Table	\$2,030
V96	96"	Rectangular Table	\$2,030
VERTICAL CART			
V4854	Up to 54"	Round/Square Table	\$2,165
V6072	Up to 72"	Round/Square Table	\$2,165
FLAT CART			
F60	60"	Rectangular Table	\$1,488
F72	72"	Rectangular Table	\$1,488
F84	84"	Rectangular Table	\$1,488
F96	96"	Rectangular Table	\$1,488



UPHOLSTERED BOOTHS

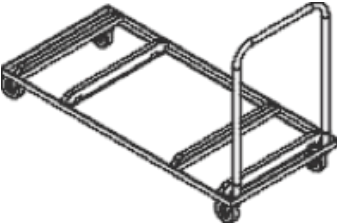
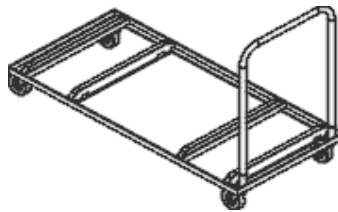
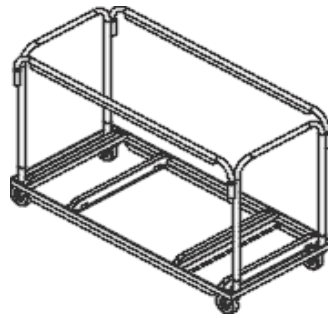

UPHOLSTERED BOOTH SPECIFICATIONS

UPHOLSTERED BOOTH SPECIFICATIONS

When it comes to upholstered booths, the options are limitless. Berco offers every imaginable upholstery option, and if you don't see what you are looking for in our standard collection, chances are our Customer Service team can find a solution to meet your specific needs.

Standard booths can be made to special sizes, angles, trim, cutouts, seats, special sewing, etc. We welcome all special requests. All circles and wall benches are standard with unfinished outside backs. Please specify if you would like a finished outside back. When circles, wall benches, curvettes or any specials are ordered, please send along a Plan with dimensions written in. Berco can also help you design to your specifications. Our Customer Service staff will assist you in meeting your customer's specific needs.

Booth Components

Booth Components

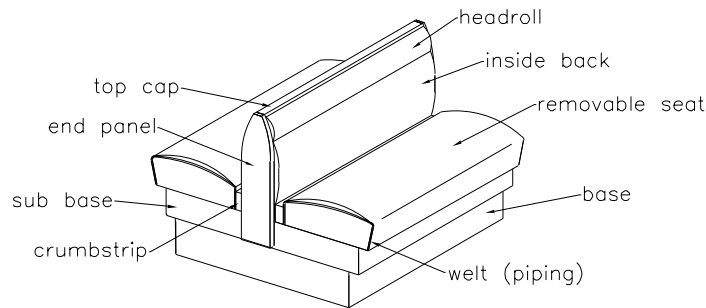

Pricing For Wall Benches

Angled Wall Bench

Total feet of sides A, B and C multiplied by the per foot price. PLUS 2 angled mitered corners equals total price. Price of finished outside backs (where required) must be added.

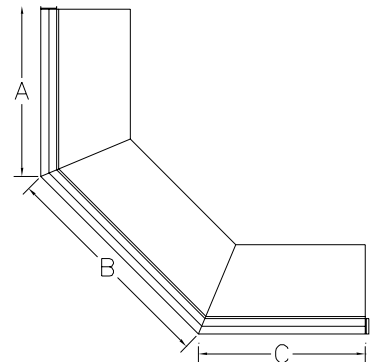

Corner Wall Bench

Total feet of sides A and B multiplied by the per foot price. PLUS 1 corner equals total price. of finished outside backs (where required) must be added.

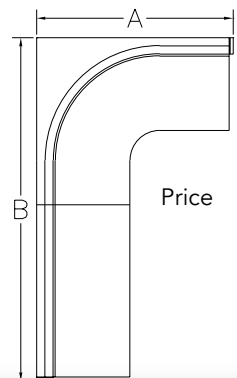

UPHOLSTERED BOOTH SPECIFICATIONS

Pricing For Circle Booths

½ Circle Booth

Total feet of sides A, B and C multiplied by the per foot price. PLUS 2 corners equals total price. Price of finished outside backs (where required) must be added.

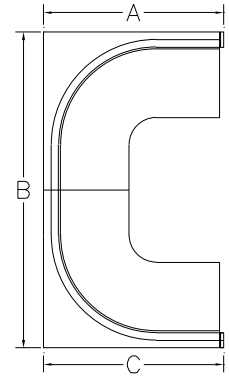

¾ Circle Booth

Total feet of sides A, B, C and D multiplied by the per foot price. PLUS 3 corners equals total price. Price of finished outside backs (where required) must be added.

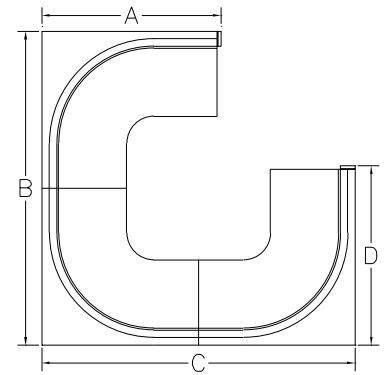

Radius Options

A Radius

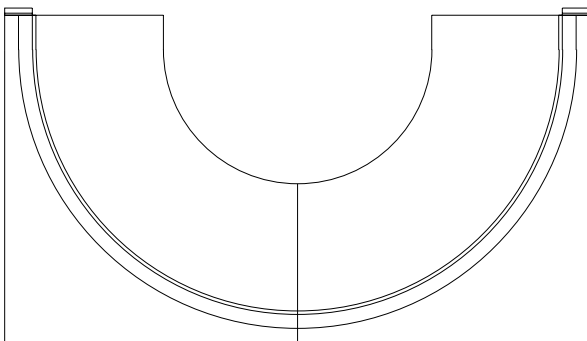

B Radius

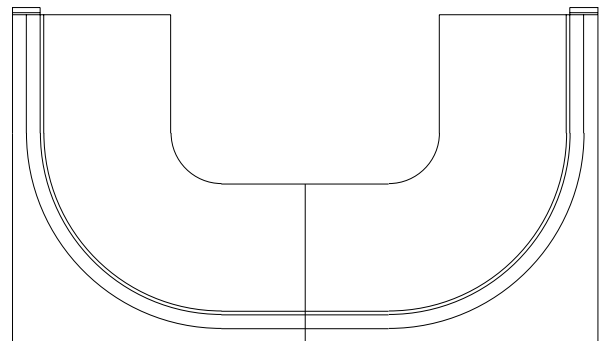

Seating Capacity

Each booth/wall bench can seat the following:

- 30" Long – 1 person
- 48" Long – 2 people
- 60" Long – 2-3 people
- 72" Long – 3-4 people

UPHOLSTERED BOOTH SPECIFICATIONS

Typical Booth Arrangement

Our booths are designed to accommodate any size and configuration you desire. As a guide for arrangement, you can reference the following drawings which allow for a 30" wide table. The style of the booth and inside back style can affect the dimension from the table top to the inside back. Use dimensions for reference only.

UPHOLSTERED BOOTHS

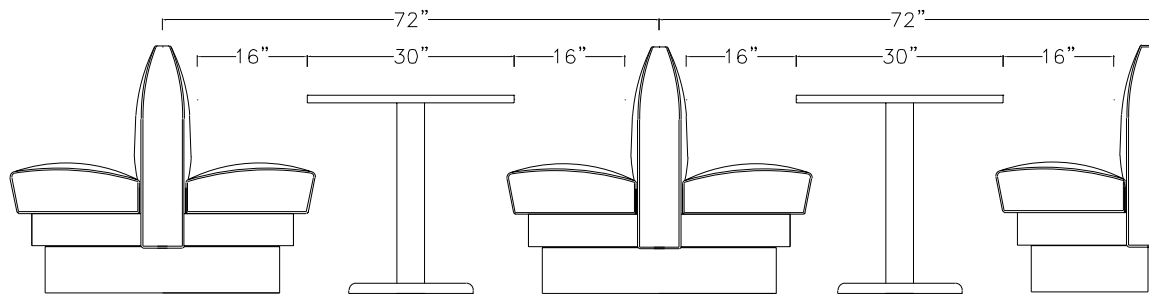

Upholstery Choices

Booth pricing includes Berco standard as well as graded-in upholstery. Standard upholstery colors are shown on following pages. For all other upholstery options, Customer Service will be happy to provide a custom quote.

Vinyl & Fabric Options

Berco can supply almost any vinyl or fabric on the market. Please consult your Customer Service Representative for a custom quote. Vinyl specifications and samples can be found at www.spradlingvinyl.com. Fabric specifications and samples can be found at www.mayerfabrics.com. See Finish Specifications section for more details.

UPHOLSTERED BOOTH SPECIFICATIONS

Customer Own Material (C.O.M.)

1. All orders using COM, prior to order, must submit upholstery details such as pattern, repeat and if it is a Railroaded pattern to customer service to determine yardage needed.
2. Standard booth pricing includes C.O.M.
3. Material that is directional or striped, must specify the details concerning how it is to be applied.
4. If material is or can be reversible, be certain to mark the proper side.
5. Supply your shipper of the C.O.M. with the following information to be attached to the outside of the package containing your C.O.M.:

Berco Furniture Solutions – Shipping & Receiving

3700 Cleon Street

St. Louis, MO 63118

Clearly mark with Purchase Order number and job name.

Upholstery Cleaning and Maintenance

General Care and Cleaning Guide:

Step 1: For light soiling, a solution of 10% household liquid dishsoap in warm water, applied with a soft damp cloth. Rinse with clean water and dry.

Step 2: For heavy soiling, dampen a soft white cloth with a one to one (1:1) solution of Fantastik® and water or Formula 409® and water. Rub gently and rinse with a water dampened cloth.

Step 3: For more difficult stains, dampen a soft white cloth with a solution of household bleach (10% bleach / 90% water). Rub gently and rinse with a water dampened cloth to remove bleach concentration. Do not use with alcohol based cleaning agents!

BOOTHS - MARQUIS



Key Features:

- * Fully upholstered booth
- * Removable, high density foam padded, sinuous spring seat
- * Foam padded inside back
- * Black vinyl enclosed base
- * Custom heights and lengths available
- * 12 year warranty

Inside Back Upgrades:

- VC - Vertical Channel
- HC - Horizontal Channel
- DT - Diamond Tuft - **ADD 20%**
- BT - Biscuit Tuft - **ADD 20%**
- HR - Headroll

36" HIGH	DEUCE SINGLE		DEUCE DOUBLE		SINGLE		DOUBLE		WALL BENCH		CORNER	
MODEL NUMBER	MARQ-3630-SGL		MARQ-3630-DBL		MARQ-3648SGL		MARQ-3648DBL		MARQ-36-WB		MARQ-36-CORNER	
DIMENSIONS	Height		36"		36"		36"		36"		36"	
	Length		30"		30"		48"		48"		Per Lineal Ft.	
	Depth		23"		44"		23"		44"		23"	
	Seat Height		19"		19"		19"		19"		19"	
	Seat Depth		18.25"		18.25"		18.25"		18.25"		18.25"	
OUTSIDE BACK	Finished		N/A		Finished		N/A		Unfinished		Unfinished	
INSIDE BACK	Smooth	Upgrade	Smooth	Upgrade	Smooth	Upgrade	Smooth	Upgrade	Smooth	Upgrade	Smooth	Upgrade
Standard/C.O.M.	\$1,490	\$1,654	\$2,289	\$2,617	\$1,779	\$2,008	\$2,674	\$3,149	\$479	\$566	\$825	\$855
GRADE 1	\$1,639	\$1,820	\$2,518	\$2,879	\$1,957	\$2,209	\$2,941	\$3,464	\$526	\$623	\$908	\$940
GRADE 2	\$1,788	\$1,985	\$2,747	\$3,141	\$2,135	\$2,410	\$3,209	\$3,778	\$574	\$680	\$990	\$1,026
GRADE 3	\$1,937	\$2,151	\$2,976	\$3,403	\$2,313	\$2,610	\$3,476	\$4,093	\$622	\$736	\$1,073	\$1,111
GRADE 4	\$2,161	\$2,399	\$3,319	\$3,795	\$2,580	\$2,912	\$3,877	\$4,566	\$694	\$821	\$1,196	\$1,239
GRADE 5	\$2,310	\$2,564	\$3,548	\$4,057	\$2,758	\$3,112	\$4,145	\$4,880	\$742	\$878	\$1,279	\$1,325
OPTIONS	Length		31" - 47" - +15%		31" - 47" - +15%		49" - 60" +25%		49" - 60" +25%		Use Per Foot for Over 60"	
	Yardage required for COM solid or non-matching upholstery.		4 yds		6 yds		5.5 yds		7 yds		2 yds per ft FOSB 1 yd per ft UFOSB	

BOOTHS - MARQUIS



Key Features:

- * Fully upholstered booth
- * Removable, high density foam padded, sinuous spring seat
- * Foam padded inside back
- * Black vinyl enclosed base
- * Custom heights and lengths available
- * 12 year warranty

Inside Back Upgrades:

- VC - Vertical Channel
- HC - Horizontal Channel
- DT - Diamond Tuft - **ADD 20%**
- BT - Biscuit Tuft - **ADD 20%**
- HR - Headroll

42" HIGH	DEUCE SINGLE		DEUCE DOUBLE		SINGLE		DOUBLE		WALL BENCH		CORNER	
MODEL NUMBER	MARQ-4230-SGL		MARQ-4230-DBL		MARQ-4248SGL		MARQ-4248DBL		MARQ-42-WB		MARQ-42-CORNER	
DIMENSIONS	Height		42"		42"		42"		42"		42"	
	Length		30"		30"		48"		48"		Per Lineal Ft.	
	Depth		23"		44"		23"		44"		23"	
	Seat Height		19"		19"		19"		19"		19"	
	Seat Depth		18.25"		18.25"		18.25"		18.25"		18.25"	
OUTSIDE BACK	Finished		N/A		Finished		N/A		Unfinished		Unfinished	
INSIDE BACK	Smooth	Upgrade	Smooth	Upgrade	Smooth	Upgrade	Smooth	Upgrade	Smooth	Upgrade	Smooth	Upgrade
Standard/C.O.M.	\$1,572	\$1,783	\$2,395	\$2,828	\$1,891	\$2,184	\$2,838	\$3,424	\$508	\$596	\$915	\$949
GRADE 1	\$1,730	\$1,962	\$2,634	\$3,111	\$2,080	\$2,402	\$3,122	\$3,766	\$559	\$655	\$1,007	\$1,044
GRADE 2	\$1,887	\$2,140	\$2,874	\$3,394	\$2,269	\$2,620	\$3,406	\$4,109	\$609	\$715	\$1,098	\$1,139
GRADE 3	\$2,044	\$2,318	\$3,113	\$3,677	\$2,458	\$2,839	\$3,690	\$4,451	\$660	\$774	\$1,190	\$1,234
GRADE 4	\$2,280	\$2,586	\$3,472	\$4,101	\$2,742	\$3,166	\$4,115	\$4,965	\$736	\$864	\$1,327	\$1,377
GRADE 5	\$2,437	\$2,764	\$3,712	\$4,384	\$2,931	\$3,385	\$4,399	\$5,307	\$787	\$923	\$1,419	\$1,471
OPTIONS	Length		31" - 47" - +15%		31" - 47" - +15%		49" - 60" +25%		49" - 60" +25%		Use Per Foot for Over 60"	
	Yardage required for COM solid or non-matching upholstery.		5 yds		7 yds		6.5 yds		8 yds		2.5 yds per ft FOSB 1.5 yd per ft UFOSB	

BOOTHS - MARQUIS



Key Features:

- * Fully upholstered booth
- * Removable, high density foam padded, sinuous spring seat
- * Foam padded inside back
- * Black vinyl enclosed base
- * Custom heights and lengths available
- * 12 year warranty

Inside Back Upgrades:

- VC - Vertical Channel
- HC - Horizontal Channel
- DT - Diamond Tuft - **ADD 20%**
- BT - Biscuit Tuft - **ADD 20%**
- HR - Headroll

48" HIGH	DEUCE SINGLE		DEUCE DOUBLE		SINGLE		DOUBLE		WALL BENCH		CORNER	
MODEL NUMBER	MARQ-4830-SGL		MARQ-4830-DBL		MARQ-4848SGL		MARQ-4848DBL		MARQ-48-WB		MARQ-48-CORNER	
DIMENSIONS	Height		48"		48"		48"		48"		48"	
	Length		30"		30"		48"		48"		Per Lineal Ft.	
	Depth		23"		44"		23"		44"		23"	
	Seat Height		19"		19"		19"		19"		19"	
	Seat Depth		18.25"		18.25"		18.25"		18.25"		18.25"	
OUTSIDE BACK	Finished		N/A		Finished		N/A		Unfinished		Unfinished	
INSIDE BACK	Smooth	Upgrade	Smooth	Upgrade	Smooth	Upgrade	Smooth	Upgrade	Smooth	Upgrade	Smooth	Upgrade
Standard/C.O.M.	\$1,660	\$1,906	\$2,500	\$3,028	\$2,008	\$2,360	\$2,979	\$3,711	\$537	\$625	\$1,051	\$1,091
GRADE 1	\$1,826	\$2,097	\$2,750	\$3,330	\$2,209	\$2,595	\$3,277	\$4,082	\$591	\$688	\$1,156	\$1,201
GRADE 2	\$1,992	\$2,288	\$3,000	\$3,633	\$2,410	\$2,831	\$3,574	\$4,453	\$645	\$750	\$1,261	\$1,310
GRADE 3	\$2,158	\$2,478	\$3,250	\$3,936	\$2,610	\$3,067	\$3,872	\$4,825	\$698	\$813	\$1,366	\$1,419
GRADE 4	\$2,407	\$2,764	\$3,625	\$4,390	\$2,912	\$3,421	\$4,319	\$5,381	\$779	\$906	\$1,523	\$1,583
GRADE 5	\$2,573	\$2,955	\$3,875	\$4,693	\$3,112	\$3,657	\$4,617	\$5,752	\$833	\$969	\$1,629	\$1,692
OPTIONS	Length		31" - 47" - +15%		31" - 47" - +15%		49" - 60" +25%		49" - 60" +25%		Use Per Foot for Over 60"	
	Yardage required for COM solid or non-matching upholstery.		5.5 yds		7.5 yds		7 yds		8.5 yds		3 yds per ft FOSB 2 yd per ft UFOSB	

BOOTHS - CALI



Key Features:

- * Fully upholstered booth
- * Removable, high density foam padded, sinuous spring seat
- * Foam padded inside back
- * Black vinyl enclosed base
- * Custom heights and lengths available
- * 12 year warranty

Inside Back Upgrades:

- VC - Vertical Channel
- HC - Horizontal Channel
- DT - Diamond Tuft - **ADD 20%**
- BT - Biscuit Tuft - **ADD 20%**
- HR - Headroll

36" HIGH	DEUCE SINGLE		DEUCE DOUBLE		SINGLE		DOUBLE		WALL BENCH		CORNER	
MODEL NUMBER	CALI-3630-SGL		CALI-3630-DBL		CALI-3648SGL		CALI-3648DBL		CALI-36-WB		CALI-36-CORNER	
DIMENSIONS	Height		36"		36"		36"		36"		36"	
	Length		30"		30"		48"		48"		Per Lineal Ft.	
	Depth		24"		47.25"		24"		47.25"		24"	
	Seat Height		19"		19"		19"		19"		19"	
	Seat Depth		18.25"		18.25"		18.25"		18.25"		18.25"	
OUTSIDE BACK	Finished		N/A		Finished		N/A		Unfinished		Unfinished	
INSIDE BACK	Smooth	Upgrade	Smooth	Upgrade	Smooth	Upgrade	Smooth	Upgrade	Smooth	Upgrade	Smooth	Upgrade
Standard/C.O.M.	\$1,514	\$1,725	\$2,324	\$2,758	\$1,815	\$2,102	\$2,744	\$3,324	\$479	\$566	\$825	\$855
GRADE 1	\$1,665	\$1,897	\$2,557	\$3,034	\$1,996	\$2,312	\$3,019	\$3,657	\$526	\$623	\$908	\$940
GRADE 2	\$1,817	\$2,070	\$2,789	\$3,310	\$2,177	\$2,522	\$3,293	\$3,989	\$574	\$680	\$990	\$1,026
GRADE 3	\$1,968	\$2,242	\$3,022	\$3,585	\$2,359	\$2,732	\$3,568	\$4,322	\$622	\$736	\$1,073	\$1,111
GRADE 4	\$2,195	\$2,501	\$3,370	\$3,999	\$2,631	\$3,047	\$3,979	\$4,820	\$694	\$821	\$1,196	\$1,239
GRADE 5	\$2,346	\$2,673	\$3,603	\$4,275	\$2,813	\$3,258	\$4,254	\$5,153	\$742	\$878	\$1,279	\$1,325
OPTIONS	Length		31" - 47" - +15%		31" - 47" - +15%		49" - 60" +25%		49" - 60" +25%		Use Per Foot For Over 60"	
	Yardage required for COM solid or non-matching upholstery.		4 yds		6 yds		5.5 yds		7 yds		2 yds per ft FOSB 1 yd per ft UFOSB	

BOOTHS - CALI



Key Features:

- * Fully upholstered booth
- * Removable, high density foam padded, sinuous spring seat
- * Foam padded inside back
- * Black vinyl enclosed base
- * Custom heights and lengths available
- * 12 year warranty

Inside Back Upgrades:

- VC - Vertical Channel
- HC - Horizontal Channel
- DT - Diamond Tuft - **ADD 20%**
- BT - Biscuit Tuft - **ADD 20%**
- HR - Headroll

42" HIGH	DEUCE SINGLE		DEUCE DOUBLE		SINGLE		DOUBLE		WALL BENCH		CORNER	
MODEL NUMBER	CALI-4230-SGL		CALI-4230-DBL		CALI-4248SGL		CALI-4248DBL		CALI-42-WB		CALI-42-CORNER	
DIMENSIONS	Height		42"		42"		42"		42"		42"	
	Length		30"		30"		48"		48"		Per Lineal Ft.	
	Depth		24"		47.25"		24"		47.25"		24"	
	Seat Height		19"		19"		19"		19"		19"	
	Seat Depth		18.25"		18.25"		18.25"		18.25"		18.25"	
OUTSIDE BACK	Finished		N/A		Finished		N/A		Unfinished		Unfinished	
INSIDE BACK	Smooth	Upgrade	Smooth	Upgrade	Smooth	Upgrade	Smooth	Upgrade	Smooth	Upgrade	Smooth	Upgrade
Standard/C.O.M.	\$1,602	\$1,926	\$2,430	\$2,893	\$1,926	\$2,225	\$2,891	\$3,506	\$508	\$596	\$915	\$949
GRADE 1	\$1,762	\$2,119	\$2,673	\$3,182	\$2,119	\$2,447	\$3,180	\$3,857	\$559	\$655	\$1,007	\$1,044
GRADE 2	\$1,922	\$2,311	\$2,916	\$3,471	\$2,311	\$2,670	\$3,469	\$4,207	\$609	\$715	\$1,098	\$1,139
GRADE 3	\$2,082	\$2,504	\$3,159	\$3,761	\$2,504	\$2,892	\$3,758	\$4,558	\$660	\$774	\$1,190	\$1,234
GRADE 4	\$2,322	\$2,793	\$3,523	\$4,195	\$2,793	\$3,226	\$4,192	\$5,084	\$736	\$864	\$1,327	\$1,377
GRADE 5	\$2,483	\$2,985	\$3,766	\$4,484	\$2,985	\$3,448	\$4,481	\$5,434	\$787	\$923	\$1,419	\$1,471
OPTIONS	Length		31" - 47" - +15%		31" - 47" - +15%		49" - 60" +25%		49" - 60" +25%		Use Per Foot for Over 60"	
	Yardage required for COM solid or non-matching upholstery.		5 yds		7 yds		6.5 yds		8 yds		2.5 yds per ft FOSB 1.5 yd per ft UFOSB	

BOOTHS - CALI



Key Features:

- * Fully upholstered booth
- * Removable, high density foam padded, sinuous spring seat
- * Foam padded inside back
- * Black vinyl enclosed base
- * Custom heights and lengths available
- * 12 year warranty

Inside Back Upgrades:

- VC - Vertical Channel
- HC - Horizontal Channel
- DT - Diamond Tuft - **ADD 20%**
- BT - Biscuit Tuft - **ADD 20%**
- HR - Headroll

48" HIGH	DEUCE SINGLE		DEUCE DOUBLE		SINGLE		DOUBLE		WALL BENCH		CORNER	
MODEL NUMBER	CALI-4830-SGL		CALI-4830-DBL		CALI-4848SGL		CALI-4848DBL		CALI-48-WB		CALI-48-CORNER	
DIMENSIONS	Height		48"		48"		48"		48"		48"	
	Length		30"		30"		48"		48"		Per Lineal Ft.	
	Depth		24"		47.25"		24"		47.25"		24"	
	Seat Height		19"		19"		19"		19"		19"	
	Seat Depth		18.25"		18.25"		18.25"		18.25"		18.25"	
OUTSIDE BACK	Finished		N/A		Finished		N/A		Unfinished		Unfinished	
INSIDE BACK	Smooth	Upgrade	Smooth	Upgrade	Smooth	Upgrade	Smooth	Upgrade	Smooth	Upgrade	Smooth	Upgrade
Standard/C.O.M.	\$1,690	\$1,901	\$2,606	\$3,022	\$2,043	\$2,342	\$3,037	\$3,682	\$537	\$625	\$1,051	\$1,091
GRADE 1	\$1,859	\$2,091	\$2,866	\$3,324	\$2,247	\$2,576	\$3,341	\$4,050	\$591	\$688	\$1,156	\$1,201
GRADE 2	\$2,027	\$2,281	\$3,127	\$3,626	\$2,452	\$2,810	\$3,645	\$4,418	\$645	\$750	\$1,261	\$1,310
GRADE 3	\$2,196	\$2,471	\$3,387	\$3,928	\$2,656	\$3,045	\$3,949	\$4,786	\$698	\$813	\$1,366	\$1,419
GRADE 4	\$2,450	\$2,756	\$3,778	\$4,381	\$2,963	\$3,396	\$4,404	\$5,339	\$779	\$906	\$1,523	\$1,583
GRADE 5	\$2,619	\$2,946	\$4,039	\$4,684	\$3,167	\$3,630	\$4,708	\$5,707	\$833	\$969	\$1,629	\$1,692
OPTIONS	Length		31" - 47" - +15%		31" - 47" - +15%		49" - 60" +25%		49" - 60" +25%		Use Per Foot For Over 60"	
	Yardage required for COM solid or non-matching upholstery.		5.5 yds		7.5 yds		7 yds		8.5 yds		3 yds per ft FOSB 2 yd per ft UFOSB	

BOOTHS - KINGSTON



Key Features:

- * Fully upholstered booth
- * High density foam padded, skirted sinuous spring seat
- * Foam padded inside back
- * Solid wood or metal legs
- * Custom heights and lengths available
- * 12 year warranty

Upgrade:

UA - Upholstered Arms

36" HIGH	DEUCE SINGLE		DEUCE DOUBLE		SINGLE		DOUBLE		WALL BENCH		CORNER	
MODEL NUMBER	KING-3624-SGL		KING-3624-DBL		KING-3648SGL		KING-3648DBL		KING-36-WB		KING-36-CORNER	
DIMENSIONS	Height		36"		36"		36"		36"		36"	
	Length		24"		24"		48"		48"		Per Lineal Ft.	
	Depth		26.25"		26.25"		52.75"		52.75"		26.25"	
	Seat Height		18"		18"		18"		18"		18"	
	Seat Depth		19.375"		19.375"		19.375"		19.375"		19.375"	
OUTSIDE BACK	Finished		N/A		Finished		N/A		Unfinished		Unfinished	
INSIDE BACK	Smooth	Upgrade	Smooth	Upgrade	Smooth	Upgrade	Smooth	Upgrade	Smooth	Upgrade	Smooth	Upgrade
Standard/C.O.M.	\$1,540	\$2,129	\$2,422	\$3,871	\$2,194	\$2,783	\$2,809	\$4,473	\$785	\$816	\$772	\$798
GRADE 1	\$1,694	\$2,342	\$2,664	\$4,258	\$2,414	\$3,062	\$3,090	\$4,920	\$863	\$898	\$849	\$878
GRADE 2	\$1,848	\$2,555	\$2,906	\$4,645	\$2,633	\$3,340	\$3,371	\$5,368	\$941	\$979	\$926	\$958
GRADE 3	\$2,002	\$2,768	\$3,149	\$5,032	\$2,852	\$3,618	\$3,652	\$5,815	\$1,020	\$1,061	\$1,003	\$1,038
GRADE 4	\$2,233	\$3,087	\$3,512	\$5,613	\$3,182	\$4,036	\$4,074	\$6,486	\$1,138	\$1,183	\$1,119	\$1,158
GRADE 5	\$2,387	\$3,300	\$3,754	\$6,000	\$3,401	\$4,314	\$4,355	\$6,933	\$1,216	\$1,265	\$1,196	\$1,238
OPTIONS	Length		31" - 47" - +15%		31" - 47" - +15%		49" - 60" +25%		49" - 60" +25%		Use Per Foot For Over 60"	
	Yardage required for COM solid or non-matching upholstery.		4 yds		8 yds		8 yds		16 yds		2 yds per ft	

BOOTHS - KINGSTON



Key Features:

- * Fully upholstered booth
- * High density foam padded, skirted sinuous spring seat
- * Foam padded inside back
- * Solid wood or metal legs
- * Custom heights and lengths available
- * 12 year warranty

Upgrade:

UA - Upholstered Arms

42" HIGH	DEUCE SINGLE		DEUCE DOUBLE		SINGLE		DOUBLE		WALL BENCH		CORNER	
MODEL NUMBER	KING-4224-SGL		KING-4224-DBL		KING-4248SGL		KING-4248DBL		KING-42-WB		KING-42-CORNER	
DIMENSIONS	Height		42"		42"		42"		42"		42"	
	Length		24"		24"		48"		48"		Per Lineal Ft.	
	Depth		26.25"		26.25"		52.75"		52.75"		26.25"	
	Seat Height		18"		18"		18"		18"		18"	
	Seat Depth		19.375"		19.375"		19.375"		19.375"		19.375"	
OUTSIDE BACK	Finished		N/A		Finished		N/A		Unfinished		Unfinished	
INSIDE BACK	Smooth	Upgrade	Smooth	Upgrade	Smooth	Upgrade	Smooth	Upgrade	Smooth	Upgrade	Smooth	Upgrade
Standard/C.O.M.	\$1,830	\$2,419	\$2,959	\$4,815	\$2,617	\$3,203	\$3,477	\$5,648	\$941	\$980	\$869	\$901
GRADE 1	\$2,013	\$2,661	\$3,255	\$5,296	\$2,879	\$3,524	\$3,824	\$6,213	\$1,035	\$1,078	\$956	\$991
GRADE 2	\$2,195	\$2,903	\$3,551	\$5,778	\$3,141	\$3,844	\$4,172	\$6,778	\$1,129	\$1,176	\$1,043	\$1,081
GRADE 3	\$2,378	\$3,144	\$3,847	\$6,259	\$3,403	\$4,164	\$4,520	\$7,343	\$1,223	\$1,274	\$1,130	\$1,171
GRADE 4	\$2,653	\$3,507	\$4,291	\$6,981	\$3,795	\$4,645	\$5,041	\$8,190	\$1,364	\$1,421	\$1,260	\$1,306
GRADE 5	\$2,836	\$3,749	\$4,587	\$7,463	\$4,057	\$4,965	\$5,389	\$8,755	\$1,458	\$1,519	\$1,347	\$1,396
OPTIONS	Length		31" - 47" - +15%		31" - 47" - +15%		49" - 60" +25%		49" - 60" +25%		Use Per Foot For Over 60"	
	Yardage required for COM solid or non-matching upholstery.		5 yds		9 yds		9 yds		17 yds		2.5 yds per ft	

BOOTH OPTIONS

		OPTIONS														
		Crumbstrip			Top Cap			Outside Back				Base				
	Length	Upholstered	Laminated	Wood Veneer	Laminated	Oak	Maple	Laminated	Upholstered	Oak Veneer	Maple Veneer	Black Laminate	Black ABS	Oak Veneer	Maple Veneer	Pedestal
		Add	Add	Add	Add	Add	Add	Add	Add	Add	Add	Add	Add	Add	Add	Add
Single	Up To 30"	\$54	\$43	\$50	\$39	\$25	\$36	\$201	Incl.	\$190	\$208	\$75	\$68	\$100	\$147	\$107
	31" - 44"	\$64	\$54	\$61	\$54	\$32	\$47	\$290	Incl.	\$272	\$301	\$100	\$90	\$129	\$183	\$107
	45" - 48"	\$68	\$57	\$64	\$57	\$36	\$50	\$315	Incl.	\$294	\$329	\$104	\$93	\$136	\$190	\$143
	49" - 72"	\$82	\$72	\$79	\$79	\$43	\$64	\$430	Incl.	\$401	\$448	\$136	\$122	\$175	\$236	\$183
Double	Up To 30"	\$107	\$86	\$100	\$39	\$25	\$36	N/A	N/A	N/A	N/A	\$125	\$93	\$143	\$229	\$201
	31" - 44"	\$129	\$107	\$122	\$54	\$32	\$47	N/A	N/A	N/A	N/A	\$150	\$115	\$172	\$261	\$202
	45" - 48"	\$136	\$115	\$129	\$57	\$36	\$50	N/A	N/A	N/A	N/A	\$161	\$122	\$179	\$272	\$201
	49" - 72"	\$165	\$143	\$158	\$79	\$43	\$64	N/A	N/A	N/A	N/A	\$193	\$147	\$218	\$315	\$240
Wall Bench	Per Foot	\$25	\$21	\$25	\$18	\$11	\$14	\$86	\$55	\$79	\$90	\$29	\$25	\$36	\$50	\$39
Circle	Per Foot	\$36	\$29	\$32	\$21	\$14	\$18	\$93	\$65	\$90	\$100	\$36	\$32	\$50	\$64	\$57

BOOTH OPTIONS

		OPTIONS														
		Sub-Base						Seats		Other						
Length		Laminated	Oak Side (1 End)	Oak Side (2 Ends)	Oak Veneer Front	Maple Side (1 End)	Maple Side (2 Ends)	Maple Veneer Front	Complete Seat	Seat Cover	Logo On Upholstery (< 6)	Logo On Upholstery (6+)	Bar Height Booth Seat (30") * NO FOOT REST*	Luxury Foam Upgrade	Line-X (PER LINEAL FOOT)	Wood or Metal Legs (Each)
		Add	Add	Add	Add	Add	Add	Add	Add	Add	Add	Add	Add	Add	Add	Add
Single	Up To 30"	\$50	\$29	\$54	\$72	\$42	\$82	\$111	\$303	\$124	\$407	\$244	+30%	\$64	\$98	\$81
	31" - 44"	\$61	\$29	\$54	\$100	\$42	\$82	\$161	\$355	\$130	\$407	\$244	+30%	\$75	\$98	\$81
	45" - 48"	\$64	\$29	\$54	\$107	\$42	\$82	\$175	\$365	\$137	\$407	\$244	+30%	\$79	\$98	\$81
	49" - 72"	\$75	\$29	\$54	\$147	\$42	\$82	\$240	\$410	\$146	\$407	\$244	+30%	\$115	\$98	\$81
Double	Up To 30"	\$100	\$55	\$107	\$143	\$85	\$165	\$222	N/A	N/A	\$814	\$488	+30%	\$130	\$98	\$81
	31" - 44"	\$122	\$55	\$107	\$201	\$85	\$165	\$322	N/A	N/A	\$814	\$488	+30%	\$150	\$98	\$81
	45" - 48"	\$129	\$55	\$107	\$215	\$85	\$165	\$351	N/A	N/A	\$814	\$488	+30%	\$156	\$98	\$81
	49" - 72"	\$150	\$55	\$107	\$294	\$85	\$165	\$480	N/A	N/A	\$814	\$488	+30%	\$228	\$98	\$81
Wall Bench	Per Foot	\$18	N/A	N/A	\$29	N/A	N/A	\$47	CF	\$29	\$407	\$98	+30%	\$21	\$98	\$81
Circle	Per Foot	\$32	N/A	N/A	\$43	N/A	N/A	\$61	CF	CF	\$407	\$244	+30%	\$29	\$98	\$81

LOUNGE SEATING





CASK LOUNGE SEATING

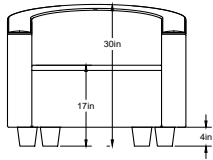
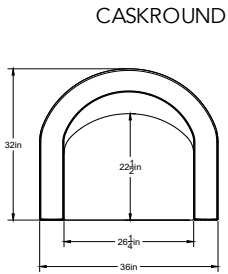
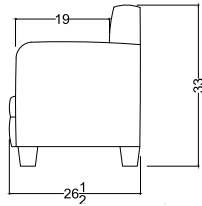
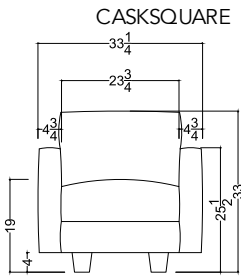

Vinyl/Fabric Grade					
Standard	Grade 1	Grade 2	Grade 3	Grade 4	Grade 5
\$1,260	\$1,386	\$1,512	\$1,638	\$1,827	\$1,953
\$1,432	\$1,575	\$1,718	\$1,862	\$2,076	\$2,220

COLLABORATIVE



PLATFORM



PLATFORM

The Platform product was created to solve the challenges of today's gathering spaces. Whether you choose to sit in solitude with a certain level of privacy or sit together in a communal lounge setting, Platform helps to meet these needs by offering comfort, connectivity, and privacy. The metal frame elevates the platform and provides a strong base but with a light scale aesthetic.

FRAME CONSTRUCTION:

The frame assembly is comprised of multi-ply hardwood with a dado and tenon construction. All cushions are made of multidensity foam to provide exceptional comfort and durability that is covered with a high slip polyethelene to keep the foam from breaking down with wear and then covered with the upholstery of your choice. The seat and back cushions are mechanically attached to the plinth (Platform) base and can be changed and interchanged with other pieces including table tops for the seat cushions.

METAL FRAME CONSTRUCTION:

The metal frame is comprised of 1-1/4" square tube welded together then polished to provide a clean aesthetic, and finished in any of our standard powder coats.

TOPS AND BACK PANELS:

The table tops for the end, coffee, and stand up tables and back privacy panel are constructed of either 3/4" MDF or particleboard material and covered in either a laminate with pvc or self edge or painted with our Krycoat painted material.

PLINTH BASE (PLATFORM):

The Platform base is constructed of multi-ply hardwood and finished in one of 6 Krycoat paint finishes to provide a tough durable finish to stand up over time.

PLATFORM



		Vinyl/Fabric Grade					Electric	BACK PANEL / TABLE TOP UPGRADES				OPTION		
		Standard	Grade 1	Grade 2	Grade 3	Grade 4	Grade 5	Cove	Laminate Upgrade I	Laminate Upgrade II	Grade 1 - Grade 3 Vinyl / Fabric	Grade 4 - Grade 5 Vinyl / Fabric	STAND UP TABLE	
								ADD	ADD	ADD	ADD	ADD	ADD	
STANDARD UNIT														
PLU3160	31"D X 60"W X 48"H Seat Height: 18" Seat Depth: 20" Seat Back Height: 34" Back Panel Height: 48"	\$4,844	\$5,063	\$5,313	\$5,625	\$5,938	\$6,102		\$114	\$417	\$349	\$601	\$677	
		Yardage required for COM solid or non-matching upholstery. If upholstery has repeat, please contact factory. 6 yds												
TABLE LEFT														
PLL3160	31"D X 60"W X 48"H Seat Height: 18" Seat Depth: 20" Seat Back Height: 34" Back Panel Height: 48"	\$4,323	\$4,433	\$4,558	\$4,714	\$4,870	\$4,952		\$114	\$417	\$349	\$601	\$677	
		Yardage required for COM solid or non-matching upholstery. If upholstery has repeat, please contact factory. 3 yds												
TABLE RIGHT														
PLR3160	31"D X 60"W X 48"H Seat Height: 18" Seat Depth: 20" Seat Back Height: 34" Back Panel Height: 48"	\$4,323	\$4,433	\$4,558	\$4,714	\$4,870	\$4,952		\$114	\$417	\$349	\$601	\$677	
		Yardage required for COM solid or non-matching upholstery. If upholstery has repeat, please contact factory. 3 yds												
LESS THAN 5' SECTION														
Per Foot Pricing		\$824	\$861	\$904	\$957	\$1,010	\$1,038		\$23	\$83	\$70	\$120	\$135	
BENCH														
PLB2060	20"D X 60"W X 18"H Seat Height: 18" Seat Depth: 20"	\$2,863	\$2,973	\$3,098	\$3,254	\$3,410	\$3,490		N/A	N/A	N/A	N/A	N/A	
		Yardage required for COM solid or non-matching upholstery. If upholstery has repeat, please contact factory. 2 yds												
COFFEE TABLE														
PLC2060	20"D X 60"W X 13"H	\$2,343	N/A	N/A	N/A	N/A	N/A		\$53	\$210	N/A	N/A	N/A	

See Electric Price Pages

FINISH CHOICES:

- Frame: Any Standard Powdercoat Finish
- Platform: Any Standard Krycoat Finish (see below)
- Seat Cushion: Any Grade Fabric/Vinyl or C.O.M.
- Back Cushion: Any Grade Fabric/Vinyl or C.O.M.
- Table Top: Any Laminate/PVC or Standard Krycoat
- Back Panel: Any Laminate, Standard Krycoat or Vinyl/Fabric

Standard Krycoat Finishes:

- A10 Space Black
- A11 Snow
- A12 Silent Night
- A13 Night Horizon
- A14 Himalayan Trek
- A15 Baltic Grey

PLATFORM



PRE-CONFIGURED OPTIONS

PLATFORM 8

	Vinyl/Fabric Grade						Electric	BACK PANEL /TABLE TOP UPGRADES				OPTION
	Standard	Grade 1	Grade 2	Grade 3	Grade 4	Grade 5	Cove	Laminate Upgrade I	Laminate Upgrade II	Grade 1 - Grade 3 Vinyl / Fabric	Grade 4 - Grade 5 Vinyl / Fabric	STAND UP TABLE
							ADD	ADD	ADD	ADD	ADD	ADD
	\$24,220	\$25,314	\$26,564	\$28,127	\$29,689	\$30,510		\$569	\$2,086	\$1,747	\$3,006	N/A
				Yardage required for COM solid or non-matching upholstery. If upholstery has repeat, please contact factory. 24 yds								
PLATFORM 12 (Excludes Stools)	\$13,385	\$13,823	\$11,980	\$14,948	\$15,573	\$15,901		\$228	\$834	\$699	\$1,203	N/A
				Yardage required for COM solid or non-matching upholstery. If upholstery has repeat, please contact factory. 12 yds								
PLATFORM NY4	\$25,021	\$25,896	\$26,896	\$28,146	\$29,396	\$30,052		\$455	\$1,668	\$1,398	\$2,405	N/A
				Yardage required for COM solid or non-matching upholstery. If upholstery has repeat, please contact factory. 24 yds								



PLATFORM STOOL

	Vinyl/Fabric Grade						OPTIONS
	Standard	Grade 1	Grade 2	Grade 3	Grade 4	Grade 5	POWDERCOAT UPGRADE ADD
Short Stool	\$1,827	\$1,841	\$1,857	\$1,877	\$1,897	\$1,919	\$134
Seat Height: 24"	Yardage required for COM solid or non-matching upholstery. If upholstery has repeat, please contact factory. .75 yds						
Seat Depth: 16"							
Seat Width: 16"							
Seat Back Height: 30"							
Tall Stool	\$1,969	\$1,983	\$1,999	\$2,019	\$2,039	\$2,061	\$134
Seat Height: 28"	Yardage required for COM solid or non-matching upholstery. If upholstery has repeat, please contact factory. .75 yds						
Seat Depth: 16"							
Seat Width: 16"							
Seat Back Height: 34"							

CORE SEATING

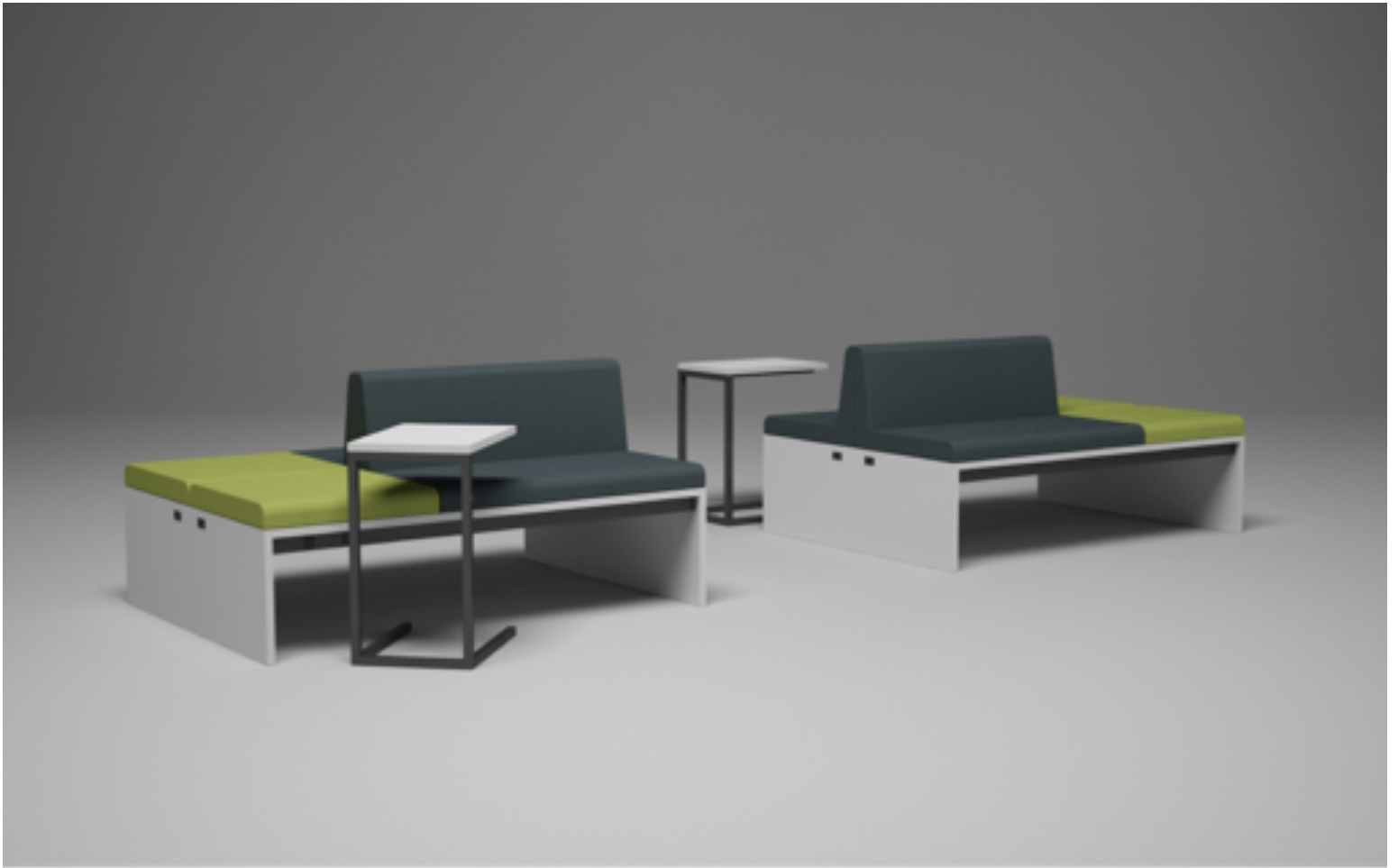

CORE SEATING

Designed with the collaborative space in mind, the Core seating line is a natural complement to our Core Table series. It offers an extensive array of options to configure your space however best fits your needs.

Construction Specifications: Based on the similar principals as our Core Table the essence of this product starts with the steel under structure comprised of a 2"x 2" cold rolled steel unit welded into one solid piece to give this seating product the strength required to hold up over time. 1" thick laminated end panels are attached to the frame, and the top component is a 1" thick laminated top attached to the end panels and frame, but still keeping the 3/16" reveal on the sides.

For seat and back cushions we use multi-density foam that is upholstered, the back for this unit is comprised of a wooden structure that slides over 1 1/4" steel tubes that are bolted to the frame.



CORE SEATING

FREESTANDING UNITS

CSRLFSXX

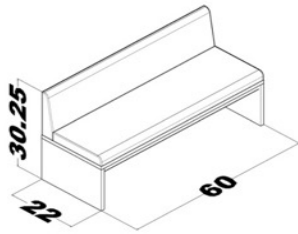

CSRLPSTB

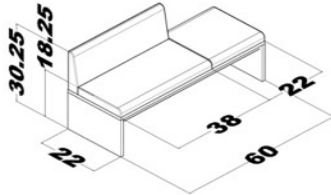

CSRLTBPS

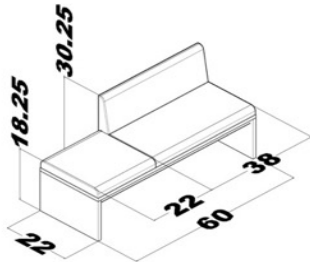

CSRLPSTT

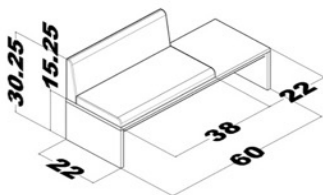

Vinyl/Fabric Grade						Upgrades			OPTIONS
Standard	Grade 1	Grade 2	Grade 3	Grade 4	Grade 5	Laminate Upgrade I	Laminate Upgrade II	Powdercoat Upgrade	Rectangular Grommet
						ADD	ADD	ADD	ADD
\$3,901	\$3,971	\$4,051	\$4,151	\$4,251	\$4,361	\$195	\$585	\$134	\$33
Yardage required for COM solid or non-matching upholstery. If upholstery has repeat please contact factory. 4 yds									
\$3,641	\$3,697	\$3,761	\$3,841	\$3,921	\$4,009	\$182	\$546	\$134	\$33
Yardage required for COM solid or non-matching upholstery. If upholstery has repeat please contact factory. 2 yds									
\$3,641	\$3,697	\$3,761	\$3,841	\$3,921	\$4,009	\$182	\$546	\$134	\$33
Yardage required for COM solid or non-matching upholstery. If upholstery has repeat please contact factory. 2 yds									
\$3,464	\$3,506	\$3,554	\$3,614	\$3,674	\$3,740	\$173	\$520	\$134	\$33
Yardage required for COM solid or non-matching upholstery. If upholstery has repeat please contact factory. 1 yd									

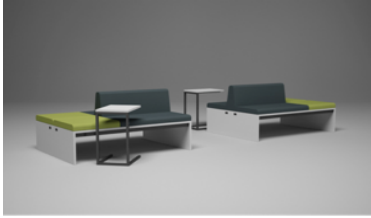

CORE SEATING

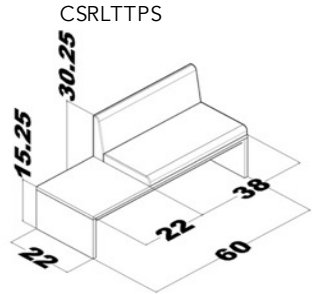

CSRLTTPS

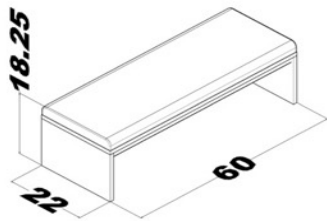

CSRLFBXX

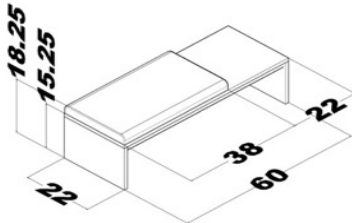

CSRLPBTT

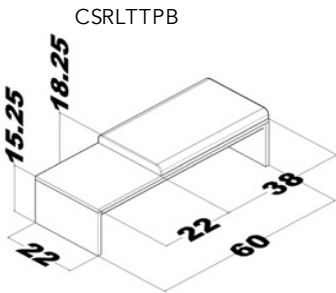

CSRLTTPB

Vinyl/Fabric Grade						Upgrades			OPTIONS
Standard	Grade 1	Grade 2	Grade 3	Grade 4	Grade 5	Laminate Upgrade I	Laminate Upgrade II	Powdercoat Upgrade	Rectangular Grommet
						ADD	ADD	ADD	ADD
\$3,464	\$3,506	\$3,554	\$3,614	\$3,674	\$3,740	\$173	\$520	\$134	\$33
Yardage required for COM solid or non-matching upholstery. If upholstery has repeat please contact factory. 1 yd									
\$3,179	\$3,207	\$3,239	\$3,279	\$3,319	\$3,363	\$159	\$477	\$134	\$33
Yardage required for COM solid or non-matching upholstery. If upholstery has repeat please contact factory. 2 yds									
\$2,991	\$3,005	\$3,021	\$3,041	\$3,061	\$3,083	\$150	\$449	\$134	\$33
Yardage required for COM solid or non-matching upholstery. If upholstery has repeat please contact factory. 1.25 yds									
\$2,991	\$3,005	\$3,021	\$3,041	\$3,061	\$3,083	\$150	\$449	\$134	\$33
Yardage required for COM solid or non-matching upholstery. If upholstery has repeat please contact factory. 1.25 yds									

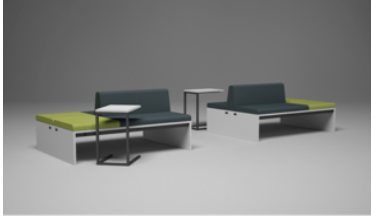

CORE SEATING

RUNOFF UNITS

CSARFSXX

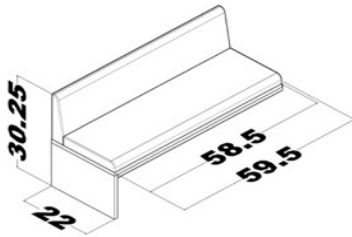

CSALFSXX

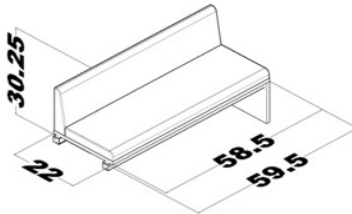

CSARTBPS

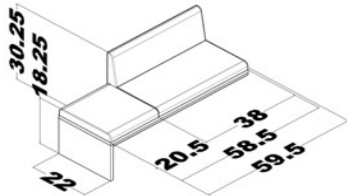

CSARPSTB

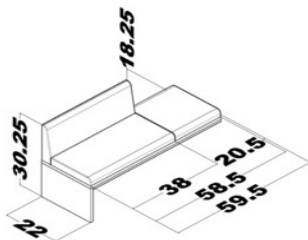

Vinyl/Fabric Grade						Upgrades			OPTIONS	
Standard	Grade 1	Grade 2	Grade 3	Grade 4	Grade 5	Laminate Upgrade I	Laminate Upgrade II	Powdercoat Upgrade	Rectangular Grommet	
						ADD	ADD	ADD	ADD	
\$3,714	\$3,784	\$3,864	\$3,964	\$4,064	\$4,174	\$186	\$557	\$134	\$33	
Yardage required for COM solid or non-matching upholstery. If upholstery has repeat please contact factory. 4 yds										
\$3,714	\$3,784	\$3,864	\$3,964	\$4,064	\$4,174	\$186	\$557	\$134	\$33	
Yardage required for COM solid or non-matching upholstery. If upholstery has repeat please contact factory. 4 yds										
\$3,453	\$3,509	\$3,573	\$3,653	\$3,733	\$3,821	\$173	\$518	\$134	\$33	
Yardage required for COM solid or non-matching upholstery. If upholstery has repeat please contact factory. 2 yds										
\$3,453	\$3,509	\$3,573	\$3,653	\$3,733	\$3,821	\$173	\$518	\$134	\$33	
Yardage required for COM solid or non-matching upholstery. If upholstery has repeat please contact factory. 2 yds										

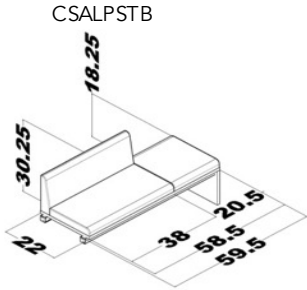
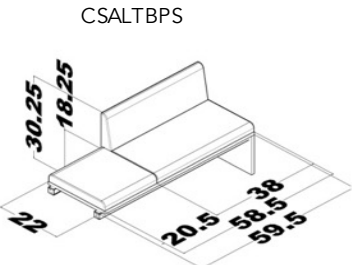
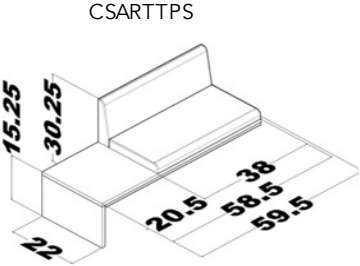
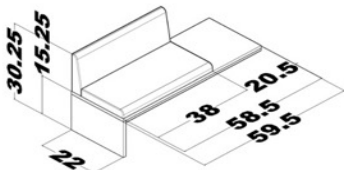

CORE SEATING

Vinyl/Fabric Grade						Upgrades			OPTIONS	
Standard	Grade 1	Grade 2	Grade 3	Grade 4	Grade 5	Laminate Upgrade I	Laminate Upgrade II	Powdercoat Upgrade	Rectangular Grommet	
						ADD	ADD	ADD	ADD	
 <p style="text-align: center;">CSALPSTB</p>	\$3,453	\$3,509	\$3,573	\$3,653	\$3,733	\$3,821	\$173	\$518	\$134	\$33
Yardage required for COM solid or non-matching upholstery. If upholstery has repeat please contact factory. 2 yds										
 <p style="text-align: center;">CSALTBPS</p>	\$3,453	\$3,509	\$3,573	\$3,653	\$3,733	\$3,821	\$173	\$518	\$134	\$33
Yardage required for COM solid or non-matching upholstery. If upholstery has repeat please contact factory. 2 yds										
 <p style="text-align: center;">CSARTTPS</p>	\$3,276	\$3,318	\$3,366	\$3,426	\$3,486	\$3,552	\$164	\$491	\$134	\$33
Yardage required for COM solid or non-matching upholstery. If upholstery has repeat please contact factory. 1 yd										
 <p style="text-align: center;">CSARPSTT</p>	\$3,276	\$3,318	\$3,366	\$3,426	\$3,486	\$3,552	\$164	\$491	\$134	\$33
Yardage required for COM solid or non-matching upholstery. If upholstery has repeat please contact factory. 1 yd										

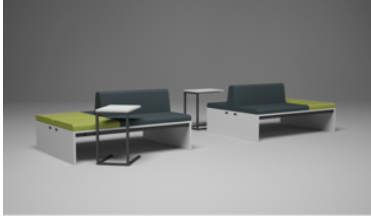

CORE SEATING

Vinyl/Fabric Grade						Upgrades			OPTIONS
Standard	Grade 1	Grade 2	Grade 3	Grade 4	Grade 5	Laminate Upgrade I	Laminate Upgrade II	Powdercoat Upgrade	Rectangular Grommet
						ADD	ADD	ADD	ADD
\$3,276	\$3,318	\$3,366	\$3,426	\$3,486	\$3,552	\$164	\$491	\$134	\$33
Yardage required for COM solid or non-matching upholstery. If upholstery has repeat please contact factory. 1 yd									
\$3,276	\$3,318	\$3,366	\$3,426	\$3,486	\$3,552	\$164	\$491	\$134	\$33
Yardage required for COM solid or non-matching upholstery. If upholstery has repeat please contact factory. 1 yd									
\$2,991	\$3,019	\$3,051	\$3,091	\$3,131	\$3,175	\$150	\$449	\$134	\$33
Yardage required for COM solid or non-matching upholstery. If upholstery has repeat please contact factory. 2 yds									
\$2,991	\$3,019	\$3,051	\$3,091	\$3,131	\$3,175	\$150	\$449	\$134	\$33
Yardage required for COM solid or non-matching upholstery. If upholstery has repeat please contact factory. 2 yds									

CSALPSTT

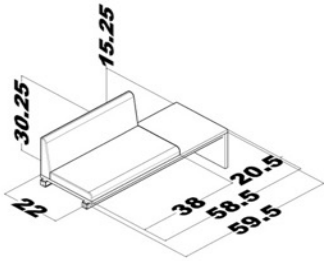

CSALTTPS

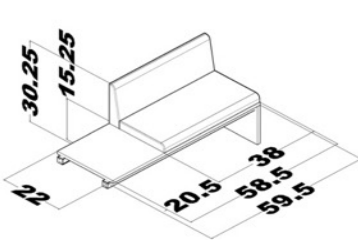

CSARBFXX

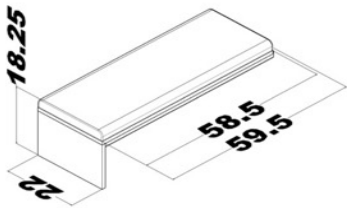

CSALFBXX

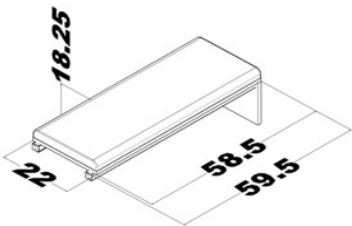

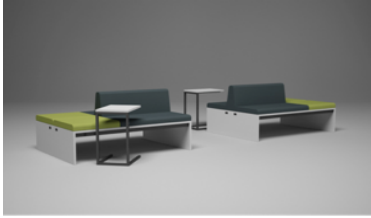

CORE SEATING

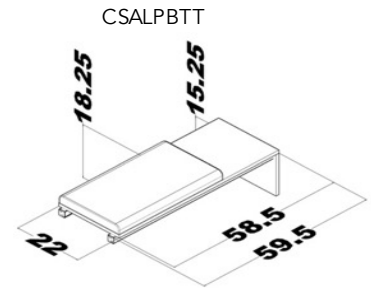

CSALPBTT

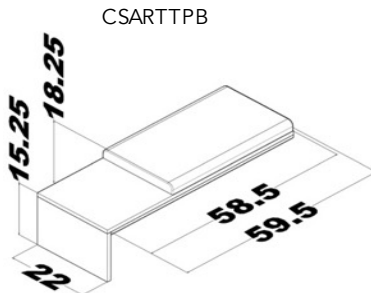

CSARTTPB

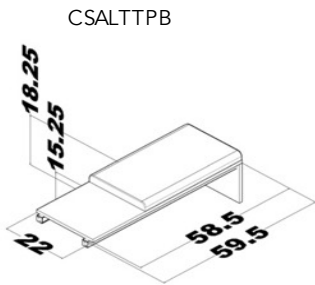

CSALTPPB

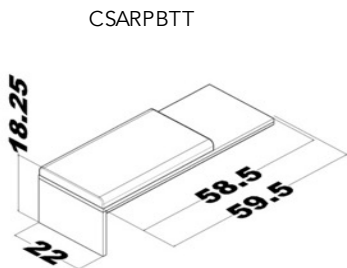

CSARPBTT

Vinyl/Fabric Grade						Upgrades			OPTIONS
Standard	Grade 1	Grade 2	Grade 3	Grade 4	Grade 5	Laminate Upgrade I	Laminate Upgrade II	Powdercoat Upgrade	Rectangular Grommet
						ADD	ADD	ADD	ADD
\$2,814	\$2,828	\$2,844	\$2,864	\$2,884	\$2,906	\$141	\$422	\$134	\$33
Yardage required for COM solid or non-matching upholstery. If upholstery has repeat please contact factory. 1.25 yds									
\$2,814	\$2,828	\$2,844	\$2,864	\$2,884	\$2,906	\$141	\$422	\$134	\$33
Yardage required for COM solid or non-matching upholstery. If upholstery has repeat please contact factory. 1.25 yds									
\$2,814	\$2,828	\$2,844	\$2,864	\$2,884	\$2,906	\$141	\$422	\$134	\$33
Yardage required for COM solid or non-matching upholstery. If upholstery has repeat please contact factory. 1.25 yds									
\$2,814	\$2,828	\$2,844	\$2,864	\$2,884	\$2,906	\$141	\$422	\$134	\$33
Yardage required for COM solid or non-matching upholstery. If upholstery has repeat please contact factory. 1.25 yds									
PER FOOT PRICING (Under 5')									
\$637	\$651	\$667	\$687	\$707	\$729	\$32	\$96	\$27	\$33

PER FOOT PRICING (Under 5')
Core Seating Per Foot Pricing

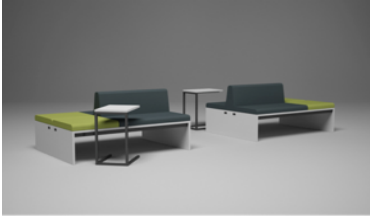

CORE SEATING

LOUNGE TABLES

CS3636

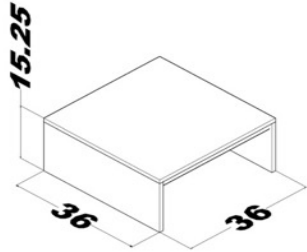

CS4848

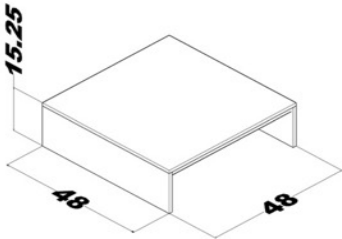

LAPTOP TABLE

CSLT

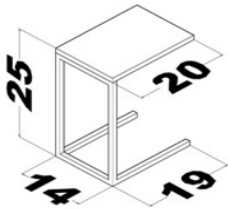

Vinyl/Fabric Grade						Upgrades			OPTIONS
Standard	Grade 1	Grade 2	Grade 3	Grade 4	Grade 5	Laminate Upgrade I	Laminate Upgrade II	Powdercoat Upgrade	Rectangular Grommet
						ADD	ADD	ADD	ADD
\$1,628	N/A	N/A	N/A	N/A	N/A	\$163	\$651	\$134	\$33
\$1,875	N/A	N/A	N/A	N/A	N/A	\$188	\$750	\$134	\$33
\$914	N/A	N/A	N/A	N/A	N/A	\$15	\$60	\$134	N/A

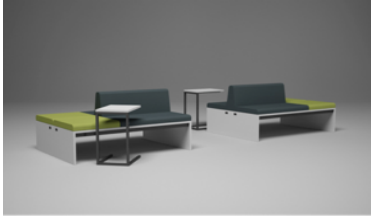

CORE SEATING

PRE-CONFIGURED OPTIONS

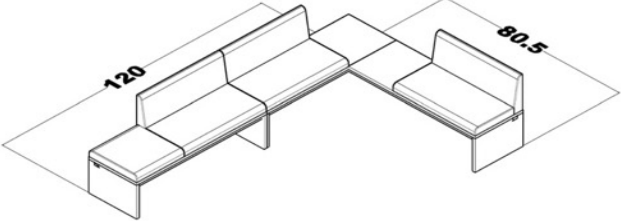
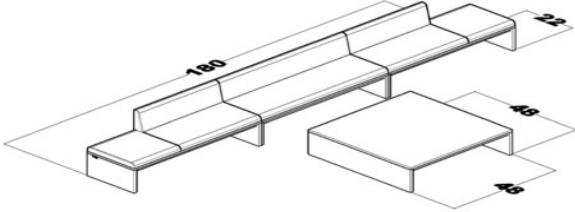
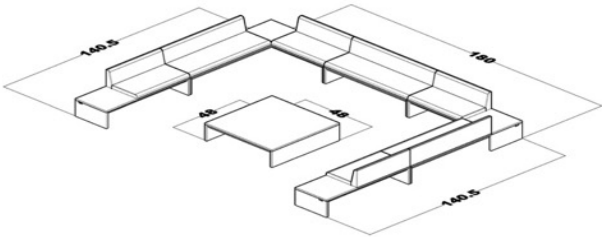
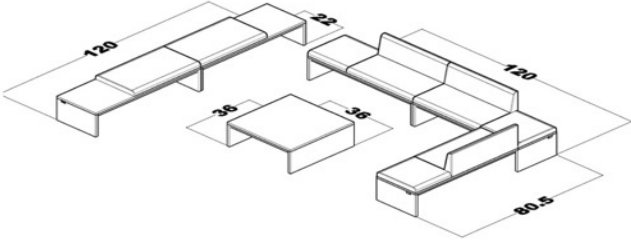
	Vinyl/Fabric Grade					Upgrades			OPTIONS	
	Standard	Grade 1	Grade 2	Grade 3	Grade 4	Grade 5	Laminate Upgrade I	Laminate Upgrade II	Powdercoat Upgrade	Rectangular Grommet
							ADD	ADD	ADD	ADD
CS2	\$10,381	\$10,521	\$10,681	\$10,881	\$11,081	\$11,301	\$519	\$1,557	\$402	\$99
 <p>Yardage required for COM solid or non-matching upholstery. If upholstery has repeat, please contact factory. 4 yds</p>										
CS4	\$13,058	\$13,240	\$13,448	\$13,708	\$13,968	\$14,254	\$747	\$2,428	\$536	\$132
 <p>Yardage required for COM solid or non-matching upholstery. If upholstery has repeat, please contact factory. 8 yds</p>										
CS10	\$27,059	\$27,437	\$27,869	\$28,409	\$28,949	\$29,543	\$1,447	\$4,528	\$1,073	\$263
 <p>Yardage required for COM solid or non-matching upholstery. If upholstery has repeat, please contact factory. 20 yds</p>										
CS12	\$18,345	\$18,541	\$18,765	\$19,045	\$19,325	\$19,633	\$999	\$3,159	\$804	\$197
 <p>Yardage required for COM solid or non-matching upholstery. If upholstery has repeat, please contact factory. 8.5 yds</p>										

MEZZANINE



MEZZANINE

Designed for today's collaborative spaces, the Mezzanine collection is a series of chairs, sofas, benches, tables, and modular components to allow your creativity to make a space the way you want it. Based on a Tuxedo Lounge design but with the added benefit of a softer feel and sit to make it a more user-friendly product, Mezzanine is your product of choice.

KEY FEATURES

- 60" and 90" sofas available in high back (48" high) and low back (25 ½" high) versions.
- High back pieces available with a long arm for greater privacy or a short arm for more social interaction.
- 60" and 90" benches and a 32" lounge chair complete the upholstered collection.
- 1-arm, armless, and corner pieces available to create modular arrangements.
- 1" x 1" square tube legs with adjustable glides, welded to a flat steel connecting plate. Base available in any standard powder coat finish. Construction method allows for 90" span with no center support.
- Frame construction made of multi-ply hardwood and particle board. Completely finished bottom panel makes Mezzanine suitable for high end applications.
- Multi-density foam construction for a softer sit. Performance Edge foam added for added comfort and superior durability.
- Throw pillows add a residential feel and allow for a punch of color or pattern. Throw pillows are permanently attached with straps discreetly connected to the bottom of the unit.
- Occasional tables available in glass, solid surface, and laminate as standard with the same 1"x 1" square tube construction. Glass tops are ½" thick tempered, low iron glass with flat polished edges and an eased 1/16" bevel on top and bottom edges as well as corners.

UPHOLSTERY

- Pricing of upholstered pieces includes fabrics up to Grade 2. Fabric for seat cushion, back + arms, and/or throw pillows can be upgraded. See price guide for fabric upcharges for each component.
- Polyurethane material is not appropriate for the seat of this unit.
- Corner pieces include 1 throw pillow positioned on a diagonal as standard.
- Throw pillows on 1-arm and armless pieces will be shorter (1-2") than the length of the seat.

COM UPHOLSTERY

- For COM orders, please verify with Customer Service that the material chosen is appropriate to be used on this product.
- Polyurethane material is not appropriate for the seat of this unit.
- See specific model number in price guide for COM requirements and pricing adjustments.
- Note: Yardage amounts are based on use of 54" wide, non-directional/non-railroaded fabric.

High-Back Units

60" Sofas

Long Arm

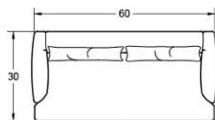

MZSHB-60LA-2AR

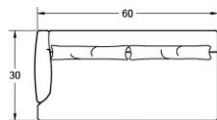

MZSHB-60LA-RAS

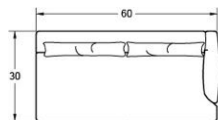

MZSHB-60LA-LAS

Short Arm

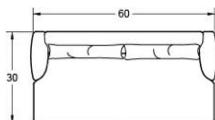

MZSHB-60SA-2AR

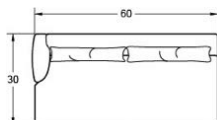

MZSHB-60SA-RAS

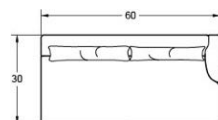

MZSHB-60SA-LAS

No Arms

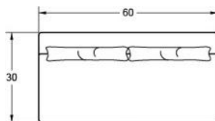

MZSHB-60-NAR

90" Sofas

Long Arm

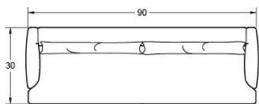

MZSHB-90LA-2AR

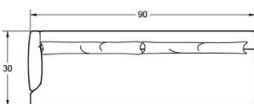

MZSHB-90LA-RAS

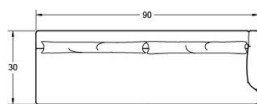

MZSHB-90LA-LAS

Short Arm

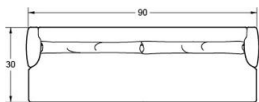

MZSHB-90SA-2AR

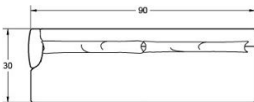

MZSHB-90SA-RAS

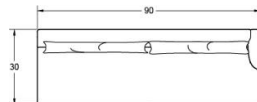

MZSHB-90SA-LAS

No Arms

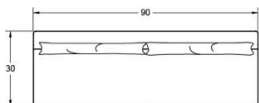

MZSHB-90-NAR

Corners

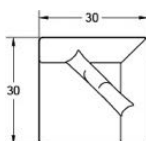

MZCRHB-30

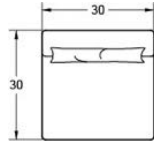

MZLCHB-30

Low-Back Units

60" Sofas

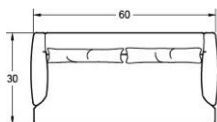

MZSLB-60LA-2AR

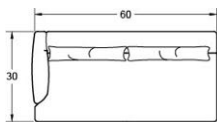

MZSLB-60LA-RAS

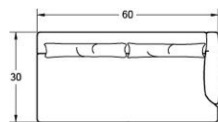

MZSLB-60LA-LAS

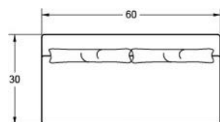

MZSLB-60-NAR

90" Sofas

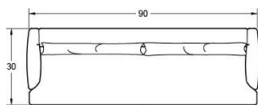

MZSLB-90LA-2AR

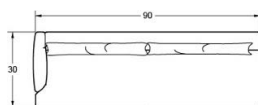

MZSLB-90LA-RAS

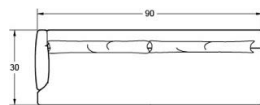

MZSLB-90LA-LAS

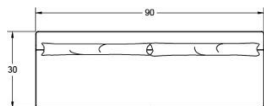

MZSLB-90-NAR

Corners

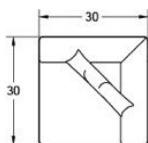

MZCRLB-30

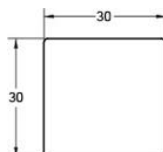

MZB-30

Lounge Chairs

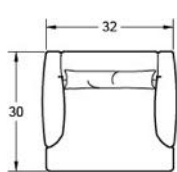

MZCH-32

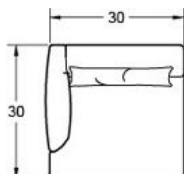

MZLC-30-RAS

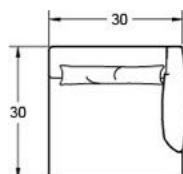

MZLC-30-LAS

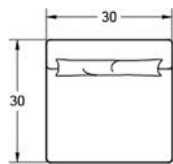

MZLCLB-30

Benches

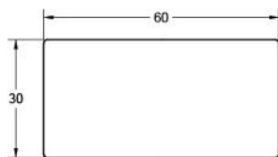

MZB-60

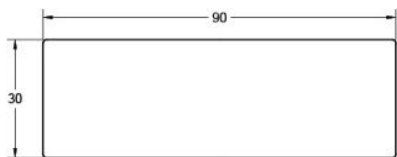

MZB-90

Tables

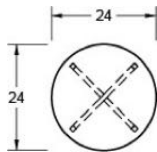

MZT-24R

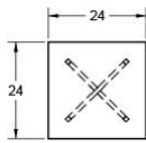

MZT-2424

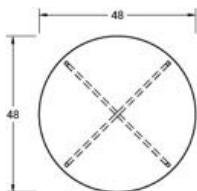

MZT-48R

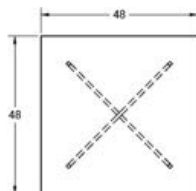

MZT-4848

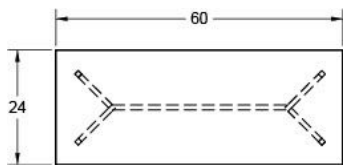

MZT-2460



MEZZANINE

List Price (Up To Grade 2)	C.O.M. Yardage	C.O.M. (DEDUCT)	Grade 3 Upgrade (ADD)	Grade 4 Upgrade (ADD)	Grade 5 Upgrade (ADD)	Grade 6 Upgrade (ADD)	Grade 7 Upgrade (ADD)	Grade 8 Upgrade (ADD)	Grade 9 Upgrade (ADD)	Grade 10 Upgrade (ADD)
----------------------------	----------------	-----------------	-----------------------	-----------------------	-----------------------	-----------------------	-----------------------	-----------------------	-----------------------	------------------------

HIGH BACK SOFA OPTIONS

60" HIGH BACK SOFA - LONG ARM

MZSHB-60LA-2AR	2 Arms	\$ 4,948										
MZSHB-60LA-LAS	1 Arm LAS	\$ 4,753										
MZSHB-60LA-RAS	1 Arm RAS	\$ 4,753										
Fabric Upcharges	Seat		4.5	\$ (146)	\$ 141	\$ 281	\$ 422	\$ 563	\$ 703	\$ 844	\$ 984	\$ 1,125
	Back/Arms		4.5	\$ (146)	\$ 141	\$ 281	\$ 422	\$ 563	\$ 703	\$ 844	\$ 984	\$ 1,125
	Throw Pillows		2.0	\$ (65)	\$ 63	\$ 125	\$ 188	\$ 250	\$ 313	\$ 375	\$ 438	\$ 500

90" HIGH BACK SOFA - LONG ARM

MZSHB-90LA-2AR	2 Arms	\$ 6,185										
MZSHB-90LA-LAS	1 Arm LAS	\$ 5,990										
MZSHN-90LA-RAS	1 Arm RAS	\$ 5,990										
Fabric Upcharges	Seat		6.5	\$ (211)	\$ 203	\$ 406	\$ 609	\$ 813	\$ 1,016	\$ 1,219	\$ 1,422	\$ 1,625
	Back/Arms		7.5	\$ (244)	\$ 234	\$ 469	\$ 703	\$ 938	\$ 1,172	\$ 1,406	\$ 1,641	\$ 1,875
	Throw Pillows		3.0	\$ (98)	\$ 94	\$ 188	\$ 281	\$ 375	\$ 469	\$ 563	\$ 656	\$ 750

60" HIGH BACK SOFA - SHORT ARM

MZSHB-60SA-2AR	2 Arms	\$ 4,688										
MZSHB-60SA-LAS	1 Arm LAS	\$ 4,492										
MZSHB-60SA-RAS	1 Arm RAS	\$ 4,492										
Fabric Upcharges	Seat		4.5	\$ (146)	\$ 141	\$ 281	\$ 422	\$ 563	\$ 703	\$ 844	\$ 984	\$ 1,125
	Back/Arms		4.5	\$ (146)	\$ 141	\$ 281	\$ 422	\$ 563	\$ 703	\$ 844	\$ 984	\$ 1,125
	Throw Pillows		2.0	\$ (65)	\$ 63	\$ 125	\$ 188	\$ 250	\$ 313	\$ 375	\$ 438	\$ 500

90" HIGH BACK SOFA - SHORT ARM

MZSHB-90SA-2AR	2 Arms	\$ 5,990										
MZSHB-90SA-LAS	1 Arm LAS	\$ 5,795										
MZSHB-90SA-RAS	1 Arm RAS	\$ 5,795										
Fabric Upcharges	Seat		6.5	\$ (211)	\$ 203	\$ 406	\$ 609	\$ 813	\$ 1,016	\$ 1,219	\$ 1,422	\$ 1,625
	Back/Arms		7.5	\$ (244)	\$ 234	\$ 469	\$ 703	\$ 938	\$ 1,172	\$ 1,406	\$ 1,641	\$ 1,875
	Throw Pillows		3.0	\$ (98)	\$ 94	\$ 188	\$ 281	\$ 375	\$ 469	\$ 563	\$ 656	\$ 750

HIGH BACK SOFA - NO ARMS

MZSHB-60-NAR	60" No Arms	\$ 4,297										
Fabric Upcharges	Seat		4.5	\$ (146)	\$ 141	\$ 281	\$ 422	\$ 563	\$ 703	\$ 844	\$ 984	\$ 1,125
	Back		2.0	\$ (146)	\$ 141	\$ 281	\$ 422	\$ 563	\$ 703	\$ 844	\$ 984	\$ 1,125
	Throw Pillows		2.0	\$ (65)	\$ 63	\$ 125	\$ 188	\$ 250	\$ 313	\$ 375	\$ 438	\$ 500
MZSHB-90-NAR	90" No Arms	\$ 5,599										
Fabric Upcharges	Seat		6.5	\$ (211)	\$ 203	\$ 406	\$ 609	\$ 813	\$ 1,016	\$ 1,219	\$ 1,422	\$ 1,625
	Back		5.0	\$ (244)	\$ 234	\$ 469	\$ 703	\$ 938	\$ 1,172	\$ 1,406	\$ 1,641	\$ 1,875
	Throw Pillows		3.0	\$ (98)	\$ 94	\$ 188	\$ 281	\$ 375	\$ 469	\$ 563	\$ 656	\$ 750

HIGH BACK CORNERS

MZCRHB-30	2 Sides	\$ 3,255										
MZLCHB-30	1 Side	\$ 3,190										
Fabric Upcharges	Seat		3.0	\$ (98)	\$ 94	\$ 188	\$ 281	\$ 375	\$ 469	\$ 563	\$ 656	\$ 750
	Back/Arms		4.5/2.25	\$ (146)	\$ 141	\$ 281	\$ 422	\$ 563	\$ 703	\$ 844	\$ 984	\$ 1,125
	Throw Pillow		1.0	\$ (33)	\$ 31	\$ 63	\$ 94	\$ 125	\$ 156	\$ 188	\$ 219	\$ 250



MEZZANINE

List Price (Up To Grade 2)	C.O.M. Yardage	C.O.M. (DEDUCT)	Grade 3 Upgrade (ADD)	Grade 4 Upgrade (ADD)	Grade 5 Upgrade (ADD)	Grade 6 Upgrade (ADD)	Grade 7 Upgrade (ADD)	Grade 8 Upgrade (ADD)	Grade 9 Upgrade (ADD)	Grade 10 Upgrade (ADD)
----------------------------	----------------	-----------------	-----------------------	-----------------------	-----------------------	-----------------------	-----------------------	-----------------------	-----------------------	------------------------

LOW BACK SOFA OPTIONS

60" LOW BACK SOFA												
MZSLB-60LA-2AR	2 Arms	\$ 4,427										
MZSLB-60LA-LAS	1 Arm LAS	\$ 4,232										
MZSLB-60LA-RAS	1 Arm RAS	\$ 4,232										
MZSLB-60-NAR	No Arms	\$ 4,037										

Fabric Upcharges	Seat	4.5	\$ (146)	\$ 141	\$ 281	\$ 422	\$ 563	\$ 703	\$ 844	\$ 984	\$ 1,125
	Back/Arms	3.25	\$ (106)	\$ 102	\$ 203	\$ 305	\$ 406	\$ 508	\$ 609	\$ 711	\$ 813
	Throw Pillows	2.0	\$ (65)	\$ 63	\$ 125	\$ 188	\$ 250	\$ 313	\$ 375	\$ 438	\$ 500

90" LOW BACK SOFA												
MZSLB-90LA-2AR	2 Arms	\$ 5,730										
MZSLB-90LA-LAS	1 Arm LAS	\$ 5,534										
MZSLB-90LA-RAS	1 Arm RAS	\$ 5,534										
MZSLB-90-NAR	No Arms	\$ 5,339										

Fabric Upcharges	Seat	6.5	\$ (211)	\$ 203	\$ 406	\$ 609	\$ 813	\$ 1,016	\$ 1,219	\$ 1,422	\$ 1,625
	Back/Arms	5.0	\$ (163)	\$ 156	\$ 313	\$ 469	\$ 625	\$ 781	\$ 938	\$ 1,094	\$ 1,250
	Throw Pillows	3.0	\$ (98)	\$ 94	\$ 188	\$ 281	\$ 375	\$ 469	\$ 563	\$ 656	\$ 750

LOW BACK CORNERS												
MZB-30	No Sides	\$ 2,350										
MZCRLB-30	2 Sides	\$ 2,400										

Fabric Upcharges	Seat	3.0	\$ (98)	\$ 94	\$ 188	\$ 281	\$ 375	\$ 469	\$ 563	\$ 656	\$ 750
	Back/Arms	3.0/1.0	\$ (98)	\$ 94	\$ 188	\$ 281	\$ 375	\$ 469	\$ 563	\$ 656	\$ 750
	Throw Pillow	1.0	\$ (33)	\$ 31	\$ 63	\$ 94	\$ 125	\$ 156	\$ 188	\$ 219	\$ 250

LOUNGE CHAIR

MZCH-32	2 Arms	\$ 2,995										
MZLC-30-RAS	1 Arm	\$ 2,250										
MZLC-30-LAS	1 Arm	\$ 2,250										
MZLCLB-30	No Arms	\$ 2,200										

Fabric Upcharges	Seat	3.0	\$ (98)	\$ 94	\$ 188	\$ 281	\$ 375	\$ 469	\$ 563	\$ 656	\$ 750
	Back/Arms	3.0	\$ (98)	\$ 94	\$ 188	\$ 281	\$ 375	\$ 469	\$ 563	\$ 656	\$ 750
	Throw Pillow	1.0	\$ (33)	\$ 31	\$ 63	\$ 94	\$ 125	\$ 156	\$ 188	\$ 219	\$ 250

BENCHES

MZB-60	60" Bench	\$ 2,995										
Fabric Upcharges			5.25	\$ (171)	\$ 164	\$ 328	\$ 492	\$ 656	\$ 820	\$ 984	\$ 1,148	\$ 1,313

MZB-90	90" Bench	\$ 3,646										
Fabric Upcharges			7.0	\$ (228)	\$ 219	\$ 438	\$ 656	\$ 875	\$ 1,094	\$ 1,313	\$ 1,531	\$ 1,750



MEZZANINE

Glass		Laminate	Laminate Upgrade I (ADD)	Laminate Upgrade II (ADD)		Solid Surface
-------	--	----------	--------------------------	---------------------------	--	---------------

TABLES

COFFEE TABLES							CONTACT FACTORY
MZT-2460	24"W x 60"L	\$ 3,125	\$ 1,563	\$ 78	\$ 313		
MZT-4848	48" SQUARE	\$ 3,255	\$ 1,563	\$ 78	\$ 313		
MZT-48R	48" ROUND	\$ 5,209	\$ 1,563	\$ 78	\$ 313		
END TABLES							
MZT-2424	24" SQUARE	\$ 2,083	\$ 1,172	\$ 59	\$ 234		
MZT-24R	24" ROUND	\$ 3,255	\$ 1,172	\$ 59	\$ 234		

MEDIA WALLS



MEDIA WALL

The media wall is designed for those collaborative areas where you need access to technology to work in a group setting. It is designed to coordinate with a variety of our other table products for a cohesive look.

Media Wall Specifications:

The media wall is constructed of 48# particleboard material in multiple layers to a 2 ¼" thickness with a grommet in the upper section to drop cords down from the monitor to connect your technology. There is a built-in raceway channel in the wall for the cord drop and there is an access door and grommet on the wall under the table top to allow access to connections. In addition, there are two L shaped brackets that are part of the wall to attach under the table for support. You have three standard options of table top styles from half round, wedge, or rectangular, along with a variety of bases to support the end opposite the wall.

The standard wall sizes available are 48" and 60" width and 66" and 78" height to accommodate both seated and standing height work. The wall is available in any standard laminate.



MEDIA WALLS (Note: TV & Mount EXCLUDED)

Choose Top Type & Size RECTANGLE, WEDGE, BULLET	Choose Base Style	Choose Wall Height (Width Matches Top Width)		OPTIONS					
		72" H	84" H	Laminate Upgrade I	Laminate Upgrade II	Powdercoat Upgrade	Interact Electric w/ HDMI (1)	Marina Electric w/ HDMI (2)	
				ADD	ADD	ADD	ADD	ADD	
48"W x 48"L	Anyway, Discus, Titan	\$7,563	\$7,726	5%	20%	\$134	\$712	\$6,780	
48"W x 60"L	Anyway, Discus, Titan	\$7,710	\$7,873	5%	20%	\$134	\$712	\$6,780	
48"W x 72"L	Anyway, Discus, Titan	\$7,857	\$8,020	5%	20%	\$134	\$712	\$6,780	
48"W x 84"L	Anyway, Discus, Titan	\$8,006	\$8,169	5%	20%	\$134	\$712	\$6,780	
60"W x 48"L	Anyway, Discus, Titan	\$7,710	\$7,876	5%	20%	\$134	\$712	\$6,780	
60"W x 60"L	Anyway, Discus, Titan	\$7,890	\$8,053	5%	20%	\$134	\$712	\$6,780	
60"W x 72"L	Anyway, Discus, Titan	\$8,014	\$8,176	5%	20%	\$134	\$712	\$6,780	
60"W x 84"L	Anyway, Discus, Titan	\$8,162	\$8,325	5%	20%	\$134	\$712	\$6,780	



Example: Rectangle Top & Titan Base



Example: WedgeTop & Anyway Base



Example: Bullet Top & Discus Base

(1) Interact with HDMI: INT-72-T05-108/Telecom H or INT-72-M24-108/Telecom H
(2) Marina with HDMI: MAR-H-T05-108 or MAR-H-M24-108

HOSPITALITY



METAL CHAIRS & BAR STOOLS



Metal Chairs & Bar Stools

Specifications

Berco metal chairs are made to exacting standards to provide the durability necessary for hospitality use. We offer a broad selection of designs that can be customized with different color finishes, and unlimited upholstery choices. All metal chairs are made from 16/18 gauge steel and come with Berco's 5 year limited warranty.

Upholstery Seat Options

When it comes to upholstered chairs, the options are limitless. Berco offers every imaginable upholstery option, and if you don't see what you are looking for in our standard collection, chances are our Customer Service team can find a solution to meet your specific needs. See "Standard" upholstery color choices in the Upholstered Booth section of this price list.

Solid Oak Seat Options

Solid oak seats are available in $\frac{3}{4}$ " thickness. The standard stain colors can be found in the "Wood Chairs & Bar Stools" section. We can custom match stain colors for an additional charge. (Note: Stain colors are for reference only. They appear different on a computer screen than on actual wood. Please request a stain sample for actual approval.)

Metal Chairs & Bar Stools

ALABAMA

	Height	Width	Depth	Seat Height
Chair	32"	17"	17"	18"
Bar Stool 30"	43.5"	17"	17"	30"
Bar Stool 24"	37.5"	17"	17"	24"

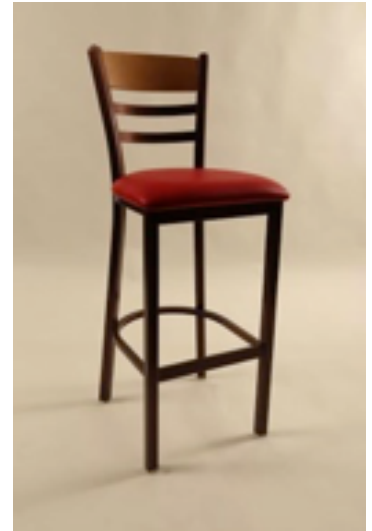

ALASKA

	Height	Width	Depth	Seat Height
Chair	31.5"	15.25"	22.5"	18"
Bar Stool 30"	43.5"	15.25"	22.5"	30"
Bar Stool 24"	37.5"	15.25"	22.5"	24"



ARIZONA

	Height	Width	Depth	Seat Height
Chair	31.5"	15.25"	22.5"	18"
Bar Stool 30"	43.5"	15.25"	22.5"	30"
Bar Stool 24"	37.5"	15.25"	22.5"	24"



Metal Chairs & Bar Stools

ARKANSAS

	Height	Width	Depth	Seat Height
Chair	32"	17"	17"	18"
Bar Stool 30"	43.5"	17"	17"	30"
Bar Stool 24"	37.5"	17"	17"	24"



CALIFORNIA

	Height	Width	Depth	Seat Height
Chair	32"	17"	17"	18"
Bar Stool 30"	43.5"	17"	17"	30"



COLORADO

	Height	Width	Depth	Seat Height
Chair	32"	17"	17"	18"
Bar Stool 30"	43.5"	17"	17"	30"
Bar Stool 24"	37.5"	17"	17"	24"



Metal Chairs & Bar Stools

DELAWARE

	Height	Width	Depth	Seat Height
Chair	32"	17"	17"	18"
Bar Stool 30"	43.5"	17"	17"	30"
Bar Stool 24"	37.5"	17"	17"	24"



FLORIDA

	Height	Width	Depth	Seat Height
Chair	32"	17"	17"	18"
Bar Stool 30"	43.5"	17"	17"	30"
Bar Stool 24"	37.5"	17"	17"	24"



Metal Chairs & Bar Stools

IDAHO

	Height	Width	Depth	Seat Height
Chair	32"	17"	17"	18"
Bar Stool 30"	43.5"	17"	17"	30"



ILLINOIS

	Height	Width	Depth	Seat Height
Chair	32"	17"	17"	18"
Barstool 30"	43.5"	17"	17"	30"
Barstool 24"	37.5"	17"	17"	24"



INDIANA

	Height	Width	Depth	Seat Height
Chair	32"	17"	17"	18"
Barstool 30"	43.5"	17"	17"	30"
Barstool 24"	37.5"	17"	17"	24"



Metal Chairs & Bar Stools

IOWA

	Height	Width	Depth	Seat Height
Chair	37"	17.5"	20"	18"
Barstool 30"	46"	17.5"	20"	30"
Barstool 24"	40"	17.5"	20"	24"



KANSAS

	Height	Width	Depth	Seat Height
Chair	32"	17"	17"	18"
Barstool 30"	43.5"	17"	17"	30"
Barstool 24"	37.5"	17"	17"	24"



KENTUCKY

	Height	Width	Depth	Seat Height
Chair	32"	17"	17"	18"
Barstool 30"	43.5"	17"	17"	30"
Barstool 24"	37.5"	17"	17"	24"



Metal Chairs & Bar Stools

MAINE

	Height	Width	Depth	Seat Height
Chair	32"	17"	17"	18"
Barstool 30"	43.5"	17"	17"	30"
Barstool 24"	37.5"	17"	17"	24"



MARYLAND

	Height	Width	Depth	Seat Height
Chair	32"	17"	17"	18"
Barstool 30"	43.5"	17"	17"	30"
Barstool 24"	37.5"	17"	17"	24"



MICHIGAN

	Height	Width	Depth	Seat Height
Chair	32"	17"	17"	18"
Barstool 30"	43.5"	17"	17"	30"
Barstool 24"	37.5"	17"	17"	24"



Metal Chairs & Bar Stools

MINNESOTA

	Height	Width	Depth	Seat Height
Barstool 30"	30"	16"	24"	30"



MISSOURI

	Height	Width	Depth	Seat Height
Chair	32"	17"	17"	18"
Barstool 30"	43.5"	17"	17"	30"
Barstool 24"	37.5"	17"	17"	24"



MONTANA

	Height	Width	Depth	Seat Height
Chair	32"	17"	17"	18"
Barstool 30"	43.5"	17"	17"	30"
Barstool 24"	37.5"	17"	17"	24"



Metal Chairs & Bar Stools

NEBRASKA

	Height	Width	Depth	Seat Height
Chair	32"	17"	17"	18"
Barstool 30"	43.5"	17"	17"	30"
Barstool 24"	37.5"	17"	17"	24"



NEVADA

	Height	Width	Depth	Seat Height
Chair	32"	17"	17"	18"
Barstool 30"	43.5"	17"	17"	30"
Barstool 24"	37.5"	17"	17"	24"



OHIO

	Height	Width	Depth	Seat Height
Chair	32"	17"	17"	18"
Barstool 30"	43.5"	17"	17"	30"
Barstool 24"	37.5"	17"	17"	24"



Metal Chairs & Bar Stools

OKLAHOMA

	Height	Width	Depth	Seat Height
Chair	32"	17"	17"	18"
Barstool 30"	43.5"	17"	17"	30"
Barstool 24"	37.5"	17"	17"	24"



OREGON

	Height	Width	Depth	Seat Height
Chair	32"	17"	17"	18"
Barstool 30"	43.5"	17"	17"	30"
Barstool 24"	37.5"	17"	17"	24"



TENNESSEE

	Height	Width	Depth	Seat Height
Chair	32"	17"	17"	18"
Barstool 30"	43.5"	17"	17"	30"
Barstool 24"	37.5"	17"	17"	24"



Metal Chairs & Bar Stools

TEXAS

	Height	Width	Depth	Seat Height
Barstool 30"	30"	17"	17"	30"
Barstool 24"	24"	17"	17"	24"



HAWAII

	Height	Width	Depth	Seat Height
Barstool 30"	30"	15"	15"	30"



Metal Chairs & Bar Stools

UTAH – Various Seat Back Options Available

	Height	Width	Depth	Seat Height
Chair	32"	17"	17"	18"
Barstool 30"	43.5"	17"	17"	30"
Barstool 24"	37.5"	17"	17"	24"



VIRGINIA

	Height	Width	Depth	Seat Height
Chair	32"	17"	17"	18"
Barstool 30"	43.5"	17"	17"	30"

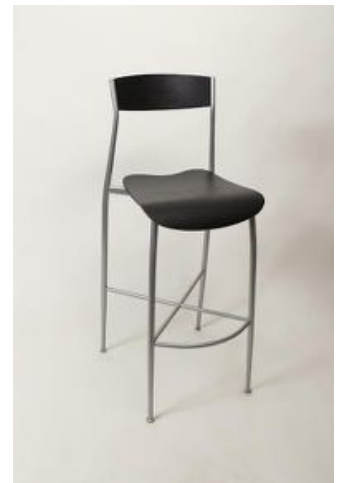

Metal Chairs & Bar Stools

WASHINGTON

	Height	Width	Depth	Seat Height
Chair	34"	14"	14"	18"
Arm Chair	29"	14"	14"	18"
Barstool 30"	30"	12"	12"	30"



HOSPITALITY - METAL CHAIRS & BAR STOOLS

NOTE: PLEASE CONTACT CUSTOMER SERVICE FOR CURRENT PRICING

	Description	Upholstered Seat (UPH)	Solid Wood Seat (WD)
ALABAMA			
BER-ALA-SLOT2-CH	Side Chair		
BER-ALA-SLOT2-BAR30	Bar Stool 30"		
BER-ALA-SLOT2-BAR24	Bar Stool 24"		
ALASKA			
BER-ALA-921-CH	Side Chair - Smooth Inside Back		N/A
BER-ALA-921BS-BAR30	Bar Stool - Smooth Inside Back 30"		N/A
ARIZONA			
BER-ARI-921V-CH	Side Chair - Channel "V" Inside Back		N/A
BER-ARI-921VBS-BAR30	Bar Stool - Channel "V" Inside Back 30"		N/A
ARKANSAS			
BER-ARK-LAD-CH	Side Chair - Ladder Back		
BER-ARK-LAD-BAR30	Bar Stool - Ladder Back - 30"		
BER-ARK-LAD-BAR24	Bar Stool - Ladder Back - 24"		
CALIFORNIA			
BER-CAL-WALK-CH	Side Chair - Wood Back		
BER-CAL-WALK-BAR30	Bar Stool - Wood Back - 30"		
COLORADO			
BER-COL-CROSS-CH	Side Chair - Crisscross Back		
BER-COL-CROSS-BAR30	Bar Stool - Crisscross Back - 30"		
BER-COL-CROSS-BAR24	Bar Stool - Crisscross Back - 24"		
DELAWARE			
BER-DEL-LAD2-CH	Side Chair - 2 Slat Back		
BER-DEL-LAD2-BAR30	Bar Stool - 2 Slat Back - 30"		
BER-DEL-LAD2-BAR24	Bar Stool - 2 Slat Back - 24"		
FLORIDA			
BER-FL-LASER-CH	Side Chair - Laser Back		
BER-FL-LASER-BAR30	Bar Stool - Laser Back - 30"		
BER-FL-LASER-BAR24	Bar Stool - Laser Back - 24"		
IDAHO			
BER-IDA-PIA-CH	Side Chair - Solid Wood Back		
BER-IDA-PIA-BAR30	Bar Stool - Solid Wood Back - 30"		

Note: Available in 2 Different Back Styles - Solid and 2 Slat

HOSPITALITY - METAL CHAIRS & BAR STOOLS

NOTE: PLEASE CONTACT CUSTOMER SERVICE FOR CURRENT PRICING

	Description	Upholstered Seat (UPH)	Solid Wood Seat (WD)
ILLINOIS			
BER-ILL-809-CH	Side Chair - Metal Slat Back		
BER-ILL-809-BAR30	Bar Stool - Metal Slat Back - 30"		
BER-ILL-809-BAR24	Bar Stool - Metal Slat Back - 24"		
INDIANA			
BER-IND-JAIL-CH	Side Chair - Vertical Metal Back		
BER-IND-JAIL-BAR30	Bar Stool - Vertical Metal Back - 30"		
BER-IND-JAIL-BAR24	Bar Stool - Vertical Metal Back - 24"		
IOWA			
BER-IOW-FBPS-CH	Side Chair		N/A
BER-IOW-FBBS-BAR30	Bar Stool 30"		N/A
BER-IOW-FBBS-BAR23	Bar Stool 24"		N/A
KANSAS			
BER-KAN-1H-CH	Side Chair - Wood Back With Hole		
BER-KAN-1H-BAR30	Bar Stool - Wood Back W/Hole - 30"		
BER-KAN-1H-BAR24	Bar Stool - Wood Back W/Hole - 24"		
KENTUCKY			
BER-KEN-3S-CH	Side Chair - Wood Back With 3 Slot		
BER-KEN-3S-BAR30	Bar Stool - Wood Back 3 Slot - 30"		
BER-KEN-3S-BAR24	Bar Stool - Wood Back 3 Slot - 24"		
MAINE			
BER-MAI-SOL-CH	Side Chair - Solid Metal Back		
BER-MAI-SOL-BAR30	Bar Stool - Solid Metal Back 30"		
BER-MAI-SOL-BAR24	Bar Stool - Solid Metal Back 24"		
MARYLAND			
BER-MAR-1H3S-CH	Side Chair - Wood 3 Slot/Hole		
BER-MAR-1H3L-BAR30	Bar Stool - Wood 3 Slot/Hole - 30"		
BER-MAR-1H3L-BAR24	Bar Stool - Wood 3 Slot/Hole Back - 24"		
MICHIGAN			
BER-MIC-5S-CH	Side Chair - Wood 5 Slot		
BER-MIC-5S-BAR30	Bar Stool - Wood 5 Slot - 30"		
BER-MIC-5S-BAR24	Bar Stool - Wood 5 Slot - 24"		

HOSPITALITY - METAL CHAIRS & BAR STOOLS

NOTE: PLEASE CONTACT CUSTOMER SERVICE FOR CURRENT PRICING

	Description	Upholstered Seat (UPH)	Solid Wood Seat (WD)
MINNESOTA			
BER-MIN-752EC-BAR30	Backless Bar Stool - 30" (Chrome)		N/A
MISSOURI			
BER-MIS-NAP-CH	Side Chair		
BER-MIS-NAP-BAR30	Bar Stool - 30"		
BER-MIS-NAP-BAR24	Bar Stool - 24"		
MONTANA			
BER-MON-LAT-CH	Side Chair - Lattice Back		
BER-MON-LAT-BAR30	Bar Stool - Lattice Back - 30"		
BER-MON-LAT-BAR24	Bar Stool - Lattice Back - 24"		
NEBRASKA			
BER-NEB-MSH-CH	Side Chair - Mesh Back		
BER-NEB-MSH-BAR30	Bar Stool - Mesh Back - 30"		
BER-NEB-MSH-BAR24	Bar Stool - Mesh Back - 24"		
NEVADA			
BER-NEV-ARCH-CH	Side Chair - Arch Back		
BER-NEV-ARCH-BAR30	Bar Stool - Arch Back - 30"		
BER-NEV-ARCH-BAR24	Bar Stool - Arch Back - 24"		
OHIO			
BER-OHI-OPST-CH	Side Chair - Straight Wood Back		
BER-OHI-OPST-BAR30	Bar Stool - Straight Wood Back - 30"		
BER-OHI-OPST-BAR24	Bar Stool - Straight Wood Back - 24"		
OKLAHOMA			
BER-OKL-OPKID-CH	Side Chair - Kidney Wood Back		
BER-OKL-OPKID-BAR30	Bar Stool - Kidney Wood Back - 30"		
BER-OKL-OPKID-BAR24	Bar Stool - Kidney Wood Back - 24"		
OREGON			
BER-ORE-ROND-CH	Side Chair - Thin Ladder Back		
BER-ORE-ROND-BAR30	Bar Stool - Thin Ladder Back - 30"		
BER-ORE-ROND-BAR24	Bar Stool - Thin Ladder Back - 24"		
TENNESSEE			
BER-TEN-VERT-CH	Side Chair - Vertical Back		
BER-TEN-VERT-BAR30	Bar Stool - Vertical Back - 30"		
BER-TEN-VERT-BAR24	Bar Stool - Vertical Back - 24"		

HOSPITALITY - METAL CHAIRS & BAR STOOLS

NOTE: PLEASE CONTACT CUSTOMER SERVICE FOR CURRENT PRICING

	Description	Upholstered Seat (UPH)	Solid Wood Seat (WD)
TEXAS			
BER-TEX-1174-BAR30	Bar Stool - No Back - 30" Uph. / 28" Wood		
BER-TEX-1174-BAR24	Bar Stool - No Back - 24"		
HAWAII			
HAW-KAR-BAR30	Bar Stool - 30"		
HAW-KAR-BAR30-M	Bar Stool - 30" Motion		
UTAH			
UTA-TUFFY-CH	Side Chair - Various Back Options Available	CF	CF
UTA-TUFFY-BAR30	Bar Stool - 30" - Various Back Options Avail.	CF	CF
UTA-TUFFY-BAR24	Bar Stool - 24" - Various Back Options Avail.	CF	CF
VIRGINIA			
VIR-COSMOS-CH	Side Chair	N/A	
VIR-COSMOS-BAR30	Bar Stool - 30"	N/A	
VIR-COSMOS-BAR24	Bar Stool - 24"	N/A	
WASHINGTON			
WASH-FLOR-CH	Side Chair		metal seat
WASH-FLOR-ARM	Arm Chair		metal seat
WASH-FLOR-BAR30	Bar Stool - 30"		metal seat
OPTIONS			
SEAT	Replacement Seat		
FOOT REST	Chrome, Brass, Brushed Alum Foot Rest Cove		
Grade 1	Grade 1 Upholstery Upgrade		N/A
Grade 2	Grade 2 Upholstery Upgrade		N/A
Grade 3	Grade 3 Upholstery Upgrade		N/A
Grade 4	Grade 4 Upholstery Upgrade		N/A
Grade 5	Grade 5 Upholstery Upgrade		N/A

WOOD CHAIRS & BAR STOOLS



Wood Chairs & Bar Stools

Specifications

Berco wood chairs are made to exacting standards to provide the durability necessary for hospitality use. We offer a broad selection of designs that can be customized with different color finishes, and unlimited upholstery choices. All wood chairs come with a 5 year limited warranty.

Upholstery Seat Options

When it comes to upholstered chairs, the options are limitless. Berco offers every imaginable upholstery option, and if you don't see what you are looking for in our standard collection, chances are our Customer Service team can find a solution to meet your specific needs. See "Standard" upholstery color choices in the Upholstered Booth section of this price list.

Standard Stain Colors

Our standard stain colors are shown in the Finish Specifications section. We can custom match stain colors for an additional charge. (Note: Stain colors are for reference only. They appear different on a computer screen than on actual wood. Please request a stain sample for actual approval.)

Wood Chairs & Bar Stools

ALEXANDER

	Height	Width	Depth	Seat Height
Chair	33.5"	18"	17"	19"
Bar Stool 30"	43"	18"	20"	31"
Bar Stool 24"	38"	18"	20"	24"



BUCHANAN

	Height	Width	Depth	Seat Height
Bar Stool 30"	30"	22"	22"	30"
Bar Stool 24"	24"	22"	22"	24"



Wood Chairs & Bar Stools

CLEVELAND

	Height	Width	Depth	Seat Height
Chair	34"	21"	17"	18"
Bar Stool 30"	44"	19"	17"	30"
Bar Stool 24"	38"	19"	17"	24"



CLINTON

	Height	Width	Depth	Seat Height
Chair	34"	17"	19"	19"
Bar Stool 30"	45"	17"	19"	31"
Bar Stool 24"	39"	17"	19"	25"



DRAKE

	Height	Width	Depth	Seat Height
Chair	34"	17"	19"	19"
Bar Stool 30"	45"	17"	19"	31"
Bar Stool 24"	39"	17"	19"	25"



Wood Chairs & Bar Stools

FRANKLIN

	Height	Width	Depth	Seat Height
Chair	34"	17"	19"	18"
Bar Stool 30"	44"	17"	19"	30"
Bar Stool 24"	38"	17"	19"	24"



JEFFERSON

	Height	Width	Depth	Seat Height
Chair	34"	17"	19"	18"
Bar Stool 30"	44"	17"	19"	30"
Bar Stool 24"	38"	17"	19"	24"



LINCOLN

	Height	Width	Depth	Seat Height
Chair	35"	17"	19"	19"
Bar Stool 30"	45"	17"	19"	31"
Bar Stool 24"	39"	17"	19"	25"



Wood Chairs & Bar Stools

MADISON

	Height	Width	Depth	Seat Height
Chair	35"	17"	19"	19"
Bar Stool 30"	45"	17"	19"	31"
Bar Stool 24"	39"	17"	19"	25"



MONROE

	Height	Width	Depth	Seat Height
Chair	34"	19"	19"	18"
Bar Stool 30"	44"	18"	19"	30"
Bar Stool 24"	38"	18"	19"	24"



REAGAN

	Height	Width	Depth	Seat Height
Chair	34"	21"	17"	18"
Bar Stool 30"	44"	19"	17"	30"
Bar Stool 24"	38"	19"	17"	24"



Wood Chairs & Bar Stools

ROOSEVELT

	Height	Width	Depth	Seat Height
Chair	34"	17"	19"	18"
Bar Stool 30"	44"	17"	19"	30"
Bar Stool 24"	38"	17"	19"	24"



STRATFORD

	Height	Width	Depth	Seat Height
Chair	34"	21"	17"	18"
Bar Stool 30"	44"	19"	17"	30"
Bar Stool 24"	38"	19"	17"	24"



WATERFORD

	Height	Width	Depth	Seat Height
Chair	35"	19"	19"	19"
Bar Stool 30"	45"	19"	19"	32"
Bar Stool 24"	38"	18"	20"	24"



HOSPITALITY - WOOD CHAIRS & BAR STOOLS

NOTE: PLEASE CONTACT CUSTOMER SERVICE FOR CURRENT PRICING

	Description	Upholstered Seat (US)	Solid Wood Seat (W)
ALEXANDER			
BER-ALEX-LAD-CH	Side Chair		
BER-ALEX-LAD-BAR30	Bar Stool 30"		
BER-ALEX-LAD-BAR24	Bar Stool 24"		
BUCHANON			
BER-BUC-HAR-BAR30	Bar Stool 30"		
BER-BUC-HAR-BAR24	Bar Stool 24"		
CLEVELAND			
BER-CLE-PRIN-CH	Side Chair		
BER-CLE-PRIN-BAR30	Bar Stool 30"		
BER-CLE-PRIN-BAR24	Bar Stool 24"		
CLINTON			
BER-CLI-JAIL-CH	Side Chair		
BER-CLI-JAIL-BAR30	Bar Stool 30"		
BER-CLI-JAIR-BAR24	Bar Stool 24"		
DRAKE			
BER-DRA-SCH-CH	Side Chair		
BER-DRA-SCH-BAR30	Bar Stool		
BER-DRA-SCH-BAR24	Bar Stool 24"		
FRANKLIN			
BER-FRA-DAN-CH	Side Chair		
BER-FRA-DAN-BAR30	Bar Stool 30"		
BER-FRA-DAN-BAR24	Bar Stool 24"		
JEFFERSON			
BER-JEF-ARL-CH	Side Chair		
BER-JEF-ARL-BAR30	Bar Stool 30"		
BER-JEF-ARL-BAR24	Bar Stool 24"		
LINCOLN			
BER-LIN-GRET-CH	Side Chair		
BER-LIN-GRET-BAR30	Bar Stool 30"		
BER-LIN-GRET-BAR24	Bar Stool 24"		
MADISON			
BER-MAD-LAT-CH	Side Chair		
BER-MAD-LAT-BAR30	Bar Stool 30"		
BER-MAD-LAT-BAR24	Bar Stool 24"		

HOSPITALITY - WOOD CHAIRS & BAR STOOLS

NOTE: PLEASE CONTACT CUSTOMER SERVICE FOR CURRENT PRICING

	Description	Upholstered Seat (US)	Solid Wood Seat (W)
MONROE			
BER-MON-STEF-CH	Side Chair		
BER-MON-STEF-BAR30	Bar Stool 30"		
BER-MON-STEF-BAR24	Bar Stool 24"		
REAGAN			
BER-REA-PAUL-CH	Side Chair		
BER-REA-PAUL-BAR30	Bar Stool 30"		
BER-REA-PAUL-BAR24	Bar Stool 24"		
ROOSEVELT			
BER-ROS-CLEO-CH	Side Chair		
BER-ROS-CLEO-BAR30	Bar Stool 30"		
BER-ROS-CLEO-BAR24	Bar Stool 24"		
STRATFORD			
BER-STR-SOLID-CH	Side Chair		
BER-STR-SOLID-BAR30	Bar Stool 30"		
BER-STR-SOLID-BAR24	Bar Stool 24"		
WATERFORD			
BER-WAT-BIED-CH	Side Chair		
BER-WAT-BIED-BAR30	Bar Stool 30"		
BER-WAT-BIED-BAR24	Bar Stool 24"		
OPTIONS			
BER-SEAT	Replacement Seat		
BER-FOOT REST	Chrome, Brass or Brushed Aluminum Foot Rest Cover		
Grade 1	Grade 1 Upholstery Upgrade		N/A
Grade 2	Grade 2 Upholstery Upgrade		N/A
Grade 3	Grade 3 Upholstery Upgrade		N/A
Grade 4	Grade 4 Upholstery Upgrade		N/A
Grade 5	Grade 5 Upholstery Upgrade		N/A

HOSPITALITY TABLE BASES



Berco's hospitality bases are cost-effective and high quality. Made from professional-grade cast iron, these bases carry a 5 year warranty. They are only available with a black wrinkle finish and must be assembled in the field.

HOSPITALITY TABLE BASE STYLES



END BASES



X BASES



ROUND BASES



BOLT DOWN BASES



CANTILEVER BASES

HOSPITALITY BASES

		Specifications					LIST PRICE
		Spider	Column	Base	Overall Height	Weight	BLACK WRINKLE
END BASES							
BER-BAS0422	End Base (Each)	13"	3"	5.25" x 20"	28.25"	14.5 LBS	\$133
BER-BAS0422BH	Bar Height End Base (Each)	13"	3"	5.25" x 20"	40.5"	14.5 LBS	\$195
X BASES							
BER-BAS2222	X Base - Up to 30"x30"	13"	3"	21.25"x21.25"	28.25"	18 LBS	\$149
BER-BAS2230	X Base - Up to 30"x48"	13"	3"	22"x29.50"	28.25"	19 LBS	\$180
BER-BAS3030	X Base - Up to 36"x36"	13"	3"	29.5"x29.5"	28.25"	21 LBS	\$186
BER-BAS3636	X Base - Up to 60" Round	24"	4"	35.5"x35.5"	28.25"	49 LBS	\$399
BER-BAS2222BH	X Base - Bar Ht. - Up to 30"x30"	13"	3"	21.25"x21.25"	40.5"	18 LBS	\$298
BER-BAS2230BH	X Base - Bar Ht. - Up to 30"x48"	13"	3"	22"x29.5"	40.5"	19 LBS	\$330
BER-BAS3030BH	X Base - Bar Ht. - Up to 36"x36"	13"	3"	29.5"x29.5"	40.5"	21 LBS	\$336
BER-BAS3636BH	X Base - Bar Ht. - Up to 60" Round	24"	4"	35.5"x35.5"	40.5"	49 LBS	\$553
ROUND BASES							
BER-BAS18ROUND	Round Base - Up to 30"x30"	13"	3"	18"	29"	33 LBS	\$234
BER-BAS22ROUND	Round Base - Up to 36"x36"	13"	3"	22"	29"	46 LBS	\$309
BER-BAS28ROUND	Round Base - Up to 60"x60"	17"	4"	28"	29"	89 LBS	\$616
BER-BAS18ROUNDB	Round Base - Bar Ht. - Up to 30"x30"	13"	3"	18"	41.5"	33 LBS	\$378
BER-BAS22ROUNDB	Round Base - Bar Ht. - Up to 36"x36"	13"	3"	22"	41.5"	46 LBS	\$453
BER-BAS28ROUNDB	Round Base - Bar Ht. - Up to 60"x60"	17"	4"	28"	41.5"	89 LBS	\$759
CANTILEVER							
BER-BAS21WL	Cantilever - 21" Long - Up to 36"x30"		2" SQR	15.5"Hx21"L		10 LBS	\$221
BER-BAS33WL	Cantilever - 33" Long - Up to 36"x48"		2" SQR	15.5"Hx31"L		12.5 LBS	\$266
BER-BAS1L	End Leg Support	4"x4"	1.25"		27.75"	2 LBS	\$141
BOLT DOWN							
BER-BAS2BD	Standard Height Bolt Down	12" SQR	3"	7.5" diameter	28.50"	10 LBS	\$299
BER-BAS2BDBH	Bar Height Bolt Down	12" SQR	3"	7.5" diameter	40.50"	12 LBS	\$335

GENERAL SPECIFICATIONS:

Cast iron construction. Black wrinkle finish. Ships with table top mounting screws. UNASSEMBLED.

HOSPITALITY X BASE INSTALLATION INSTRUCTIONS

Assemble Table Base Upside Down

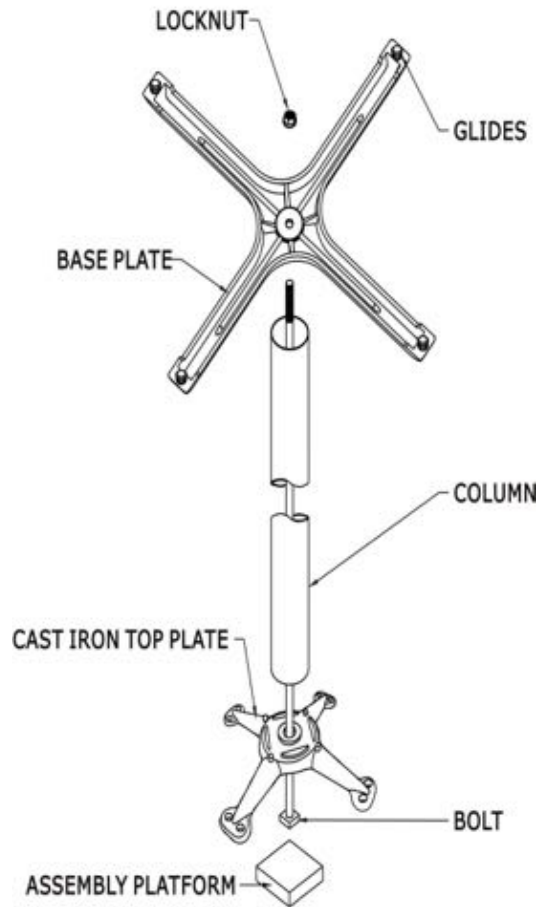

HOSPITALITY END BASE INSTALLATION INSTRUCTIONS

Assemble Table Base Upside Down

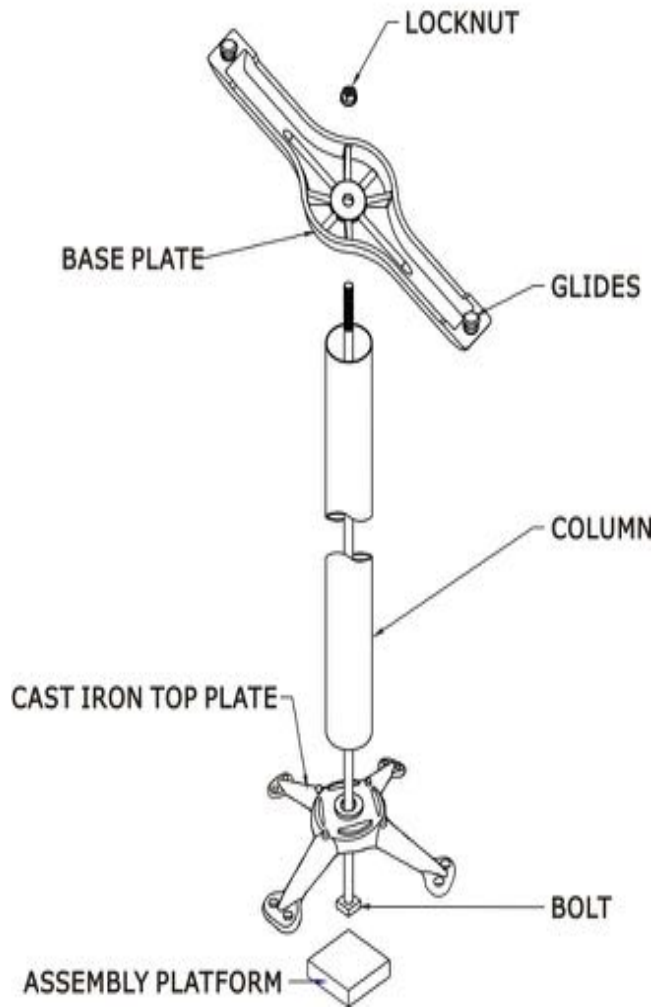

HOSPITALITY ROUND BASE INSTALLATION INSTRUCTIONS

Assemble Table Base Upside Down

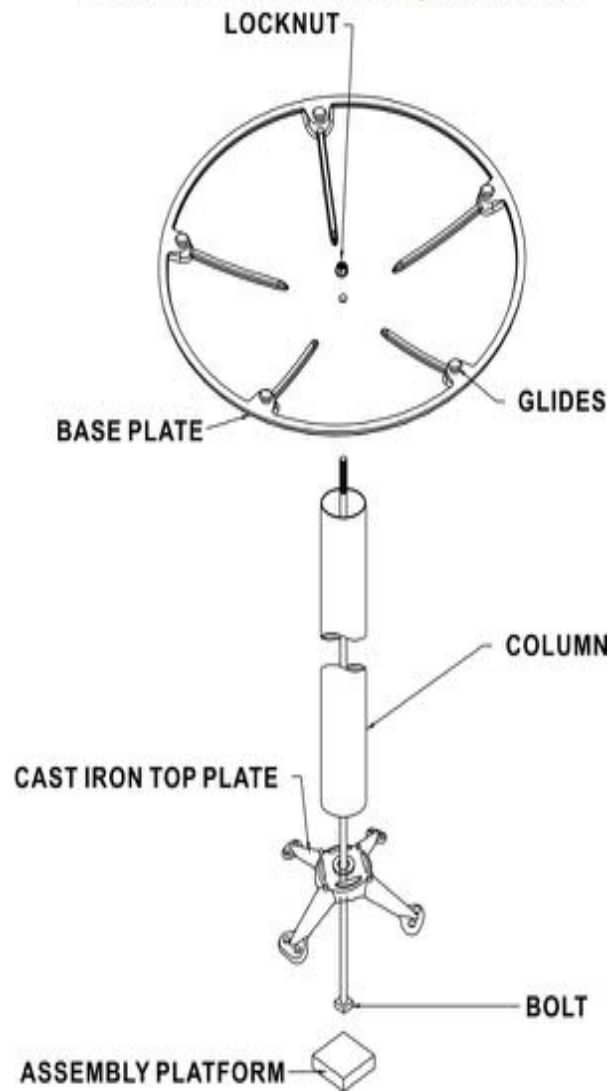



INTRODUCING
PARQUE

Tables & Chairs for Today's Outdoor Seating Needs

PRICE GUIDE

BERCO
designs

PARQUE OUTDOOR FURNITURE

Parque furniture is designed with style, comfort, and durability for the outdoor environments. The unique construction materials used in Parque allow it to withstand virtually any weather conditions.

SEATING – Chair construction is made of 100% polypropylene for strength and durability. The chairs offered can stack to be stored out of the way and are available in a variety of colors. They are easily cleaned and are maintenance free, are lightweight to be moved around quickly, and can be used indoor and outdoor. They have a minimum weight capacity of 400 lbs.

TABLES – The tables are offered in 3 different styles of bases including a cross, disc, and square plate style in either a silver or black finish, and are finished in a coating that makes them usable in an outdoor space. The tops are available in two different materials either a Sun City or Werzalit product and both are specifically made for durability in outside use and come in a variety of colors. The Sun City is offered in 11 finishes, and the Werzalit in 4 finishes.

There are options for the table heights of either 30" or 42" and are offered in a number of sizes of round and square tops.



PARQUE LADDERBACK CHAIRS

- Durable polypropylene material
- 4 Quick Ship colors ship same day from Chicago (Lime, Java, Gray, Mango)
- Custom colors available with 8 week lead time
- 70 standard Sunbrella Transcend Collection fabrics to choose from
- Stacks up to 5 high
- 500 lb. weight capacity



PARQUE TABLE COLLECTION

- Cross, disc, and square plate base styles in black or silver
- Choose 30"h seated height or 42"h bar height
- Round and rectangle tops in a variety of sizes
- Weatherproof Suncity or Werzalit tops available in a variety of colors/finishes



LIST PRICES*

30" Seated Height

42" Bar Height

Square Top Tables

30 x 30 Cross Base
32 x 32 Cross Base
36 x 36 Cross Base

Suncity Top

Werzalit Top

Suncity Top

Werzalit Top

24 x 24 Disc Base
30 x 30 Disc Base
32 x 32 Disc Base
36 x 36 Disc Base

24 x 24 Square Plate Base
30 x 30 Square Plate Base
32 x 32 Square Plate Base

Round Top Tables

28R Cross Base
30R Cross Base
36R Cross Base

24R Disc Base
28R Disc Base
30R Disc Base
36R Disc Base

24R Square Plate Base
30R Square Plate Base
32R Square Plate Base

Ladder Back Chairs

Polypropylene Seat
Sunbrella Cushioned Seat

Contact Factory For Current Pricing

SUNCITY TOP COLORS



Seaside Englewood Driftwood Pelican Bay Reef



Tropicana Scarlet Kiwi



Longwood Ruskin Oyster Bay

WERZALIT TOP COLORS



Sawcut Oak Vintage Pine Dark Concrete Mali Wenge

*List prices, include freight for orders of \$5,000 list or more. Orders less than \$5,000 list are subject to \$99 shipping charge.

STUDY CARRELS



STUDY CARRELS

For those areas where you need more privacy for studying or testing, Berco offers our Study carrel option. These Carrels are designed as an add on option to your table once you have chosen and specified the table you want, then choose the corresponding Study Carrel size to go with the table. You can choose Starters (comprised of 2 sides and 1 back panel) and then Adders (comprised of 1 side and 1 back). Don't see the exact size or style you are looking for, call us; customizing these units is always available.

When ordering please keep in mind that the construction of these units are such that tables (or at least tops) must be ordered with them as there are structural components that are embedded into the table top to support the Carrel.

Specifications: Constructed of 3/4" core with laminate on both sides and PVC edge on exposed edges and includes all necessary hardware to attach together and to table top. Standard height is 18".

Finishes: Available in most standard laminates

STUDY CARREL SPECIFICATIONS

	<u>Smart Code</u>	<u>Size</u>	<u>Description</u>
	SCS-2430	24"D x 30"W x 18"H	Starter study carrel unit
	SCA-2430	24"D x 30"W x 18"H	Add on study carrel unit
	SCS-2436	24"D x 36"W x 18"H	Starter study carrel unit
	SCA-2436	24"D x 36"W x 18"H	Add on study carrel unit

STUDY CARRELS

STUDY CARELLS

SCS-2430	24"D x 30"W x 18"H	Starter study carrel unit	\$1,522
SCA-2430	24"D x 30"W x 18"H	Add on study carrel unit	\$1,213
SCS-2436	24"D x 36"W x 18"H	Starter study carell unit	\$1,495
SCA-2436	24"D x 36"W x 18"H	Add on study carell unit	\$1,187

LIST PRICE **

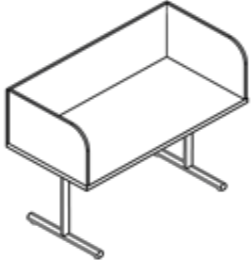

**Standard laminate pricing. C/F for special finish options.
Standard with PVC edge. C/F for special edge options.**

**** Privacy Panel List Price Only - Table top & base(s) price needs to be added to get total List**

FINISH SPECIFICATIONS



STANDARD LAMINATE FINISH SPECIFICATIONS

STANDARD LAMINATES

Berco offers dozens of standard laminate choices and can work with you to source any non-standard color or pattern from our selection of preferred laminate suppliers. The colors shown below are all from Wilsonart® laminate finishes. Berco also works with many other laminate suppliers, and can likely supply you with any color you need. Please call for more information.

White / Neutral Finishes



D30-60 Natural Almond

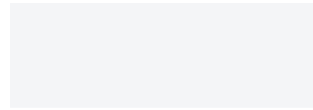

D354-60 Designer White



4621-60 White Nebula

Black / Grey Finishes



D90-60 North Sea



4783-60 White Tigris



D381-60 Fashion Grey



4795-60 Windswept Pewter



4142-60 Grey Glace

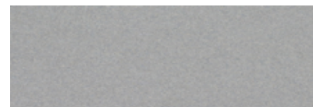

4843-60 Misted Zephyr



4622-60 Grey Nebula



4845-60 Twilight Zephyr



4623-60 Graphite Nebula

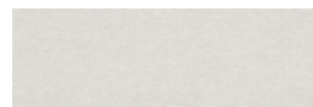

4857-60 Shadow Zephyr



4674-60 Evening Tigris



4877-38 Grey Mesh

STANDARD LAMINATES

Berco offers dozens of standard laminate choices and can work with you to source any non-standard color or pattern from our selection of preferred laminate suppliers. The colors shown below are all from Wilsonart® laminate finishes. Berco also works with many other laminate suppliers, and can likely supply you with any color you need. Please call for more information.

Brown / Taupe Finishes



D96-60 Shadow



4811-60 Silicon EV



D495-60 Coffee Bean



4841-60 Desert Zephyr

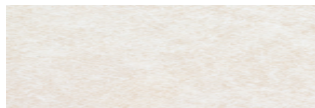

4170-60 Beige Pampas

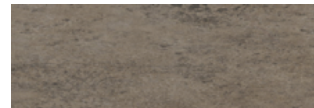

4885-38
Green Soapstone



4663-60 Tawny Legacy



4887-38
Tan Soapstone



4669-60 Natural Tigris

Red / Orange Finishes



4744-60 Harratha Brush

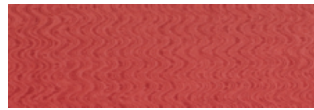

4914-60 Pomegranate

Yellow / Green / Blue Finishes



4917-60 Kiwi



4919-60 Blue Agave

STANDARD LAMINATES

Berco offers dozens of standard laminate choices and can work with you to source any non-standard color or pattern from our selection of preferred laminate suppliers. The colors shown below are all from Wilsonart® laminate finishes. Berco also works with many other laminate suppliers, and can likely supply you with any color you need. Please call for more information.

Woodgrain Finishes



7816-60 Solar Oak



7209K-78 Nepal Teak*



7054-60 Wild Cherry

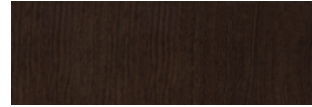

7933K-07 Cafelle*



7909-60 Fusion Maple

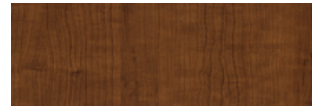

7935K-07 Shaker Cherry*



7929-38 Huntington Maple

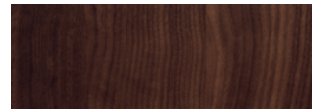

7943-07 Columbian Walnut*



7937-38 River Cherry



7949K-18 Asian Night*



7946-38 Brazilwood



7960K-18 Studio Teak*

** Premium Laminates. Upcharge will apply.*

STANDARD LAMINATES

Berco offers dozens of standard laminate choices and can work with you to source any non-standard color or pattern from our selection of preferred laminate suppliers. The colors shown below are all from Formica® laminate finishes. Berco also works with many other laminate suppliers, and can likely supply you with any color you need. Please call for more information.



507 Folkstone Grafix



837 Graphite

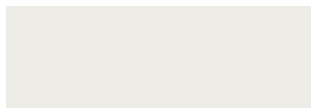

923 Surf



927 Folkstone



932 Antique White

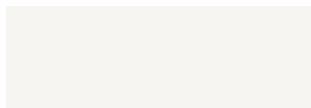

949 White



961 Fog



5488 Smoky Brown Pear



5883 Pecan Woodline



5884 Chestnut Woodline



5886 Sorrel Cherry



5904 Wild Cherry



6209 Prestige Walnut



6401 Natural Walnut



6402 Thermo Walnut



6447 Sarum Duotex

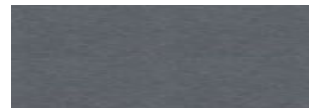

6448 Infinity Duotex



6449 Charcoal Duotex



6925 Maple Woodline

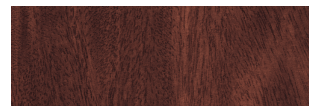

7008 Acajou Mahogany



7012 Amber Maple

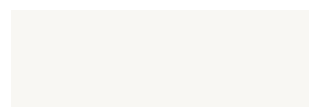

7197 Dover White

STANDARD LAMINATES

Berco offers dozens of standard laminate choices and can work with you to source any non-standard color or pattern from our selection of preferred laminate suppliers. The colors shown below are all from Formica® laminate finishes. Berco also works with many other laminate suppliers, and can likely supply you with any color you need. Please call for more information.

	7288 Ginger Root Maple		8841 White Ash
	7708 Flax Gauze		8842 Weathered Ash
	7738 Cognac Maple		8845 Bleached Legno
	7747 Pencil Wood		8846 Oiled Legno
	7759 Select Cherry		8847 Jarrah Legno
	7813 Cardboard Solidz		8848 Blackened Legno
	8824 White Drops F		8849 Natural Teak
	8824 White Drops		8905 Waxed Maple
	8826 Neutral Twill		8906 Danish Maple
	8827 Sarum Twill		9285 White Twill
	8829 Graphite Twill		909 Black

STANDARD LAMINATES

Berco offers dozens of standard laminate choices and can work with you to source any non-standard color or pattern from our selection of preferred laminate suppliers. The colors shown below are all from Formica® laminate finishes. Berco also works with many other laminate suppliers, and can likely supply you with any color you need. Please call for more information.



9236 Noble Mahogany



9240 Cherry Heartwood



9237 Sand Maple



9241 True Mahogany



9238 Chelsea Maple

UPGRADE I LAMINATES



5887 Millennium Oak



8842 Weathered Ash



6411 Cherry Riftwood



8843 Natural Ash



6414 Black Riftwood



8844 Aged Ash

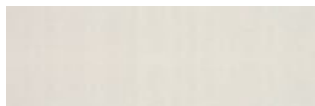

8841 White Ash



9283 Walnut Riftwood

PREMIUM LAMINATE FINISH SPECIFICATIONS

PREMIUM LAMINATES

The colors shown below are all from Formica® laminate finishes. These colors are a PREMIUM laminate. Please contact your Customer Service Representative for a quote.

Infinity Finishes



845-an Spectrum Red



851-an Spectrum Blue

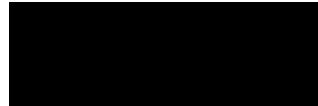

909-an Black



912-an Storm



932-an Antique White



949-an White



961-an Fog

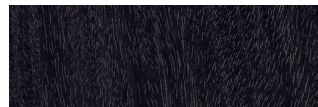

8848-an Blackened Legno



2200-an Dark Chocolate



2962-an Clementine



5323-an Nocturne



5342-an Earth



5488-an Smoky Brown Pear

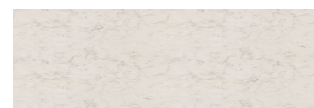

6314-an Neo Cloud



6413-an Silver Riftwood



6903-an Cassis

VINYL & FABRIC FINISH SPECIFICATIONS



BERCODESIGNS.COM | 888.772.4788 | SALES@BERCODESIGNS.COM

Note: Colors are for reference only. They may appear different on a computer screen. Actual samples provided upon request.

BERCO SPECIAL FABRIC CARD

MOMENTUM GRAPH - STANDARD



Alpine



Bark



Chalice

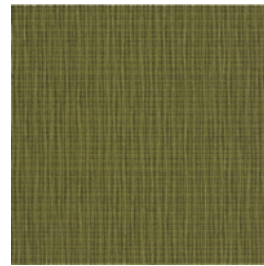

Parrot



Poppy



Ruby

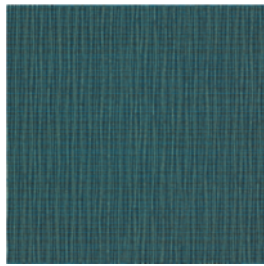

Tidal

MOMENTUM LENS – GRADE 1

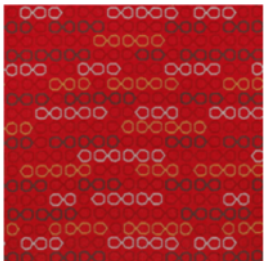

Crimson

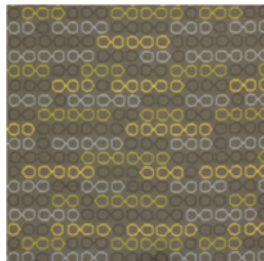

Graphite

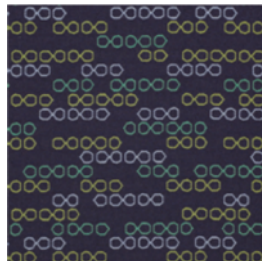

Navy



Night



Sand



Silver

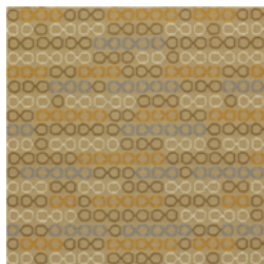

Terra

BERCO SPECIAL FABRIC CARD

MOMENTUM FAUX FELT – GRADE 2



Bark



Berry



Charcoal



Coral



Flannel

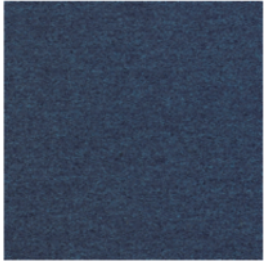

Lagoon



Path

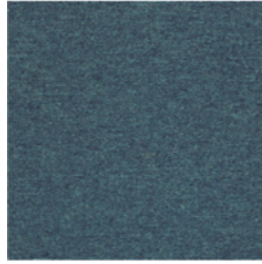

Pool



Pumice



Quail



Stone

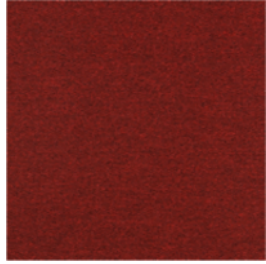

Vibrant

MOMENTUM BEEP– GRADE 2

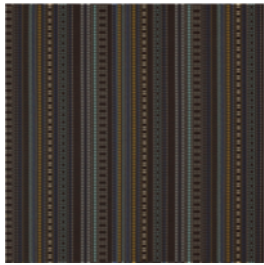

Bridge

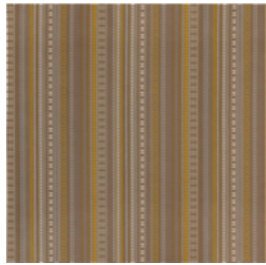

Flax



Furnace



Greenlight



Jet

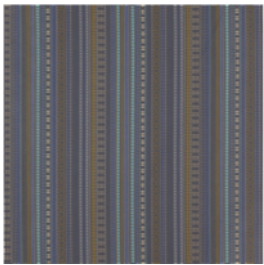

Pontoon

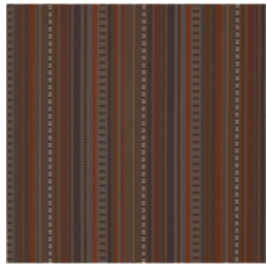

Steel

STANDARD – VINYL & FABRIC

STANDARD – VINYL – Nassimi, Espirit



Adobe White



Agean



Alabaster



American Beauty

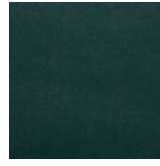

Aqua Dark



Aqua Green



Artichoke



Black

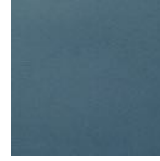

Blue Ridge

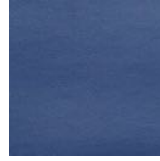

Blueberry

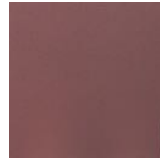

Blush

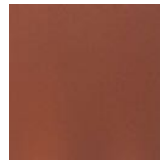

British Tan

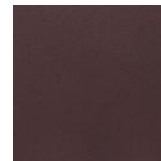

Burgundy



Celadon

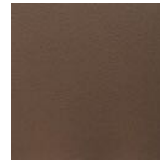

Chestnut



Claret

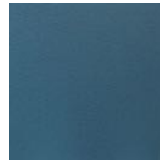

Colonial Blue



Concord

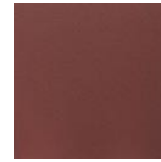

Deep Clay



Dewberry



Doe



Dove



Dusty Jade

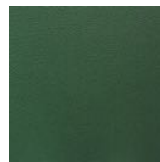

Emerald



Espresso



Flint Grey

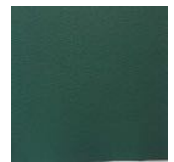

Forest

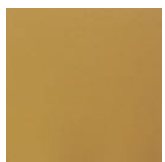

Goldenrod

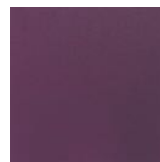

Grape

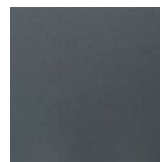

Graphite



Green Tea

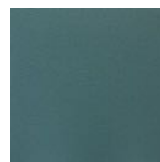

Grotto



Gunmetal

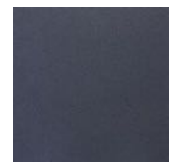

Imperial Blue



Iris



Irish Spring

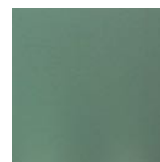

Jade

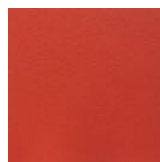

Mandarin Orange

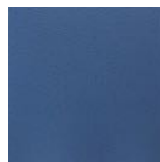

Marina

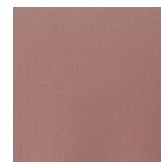

Mauve

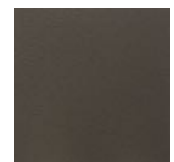

Mocha

STANDARD – VINYL & FABRIC

STANDARD – VINYL – Nassimi, Espirit (continued)



New Purple



North Woods

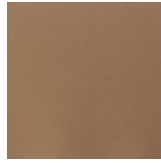

Oak



Ocean Grey



Olive Green

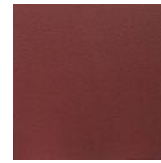

Paprika



Parchment



Peach

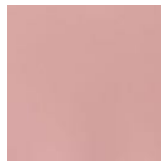

Pink



Platinum

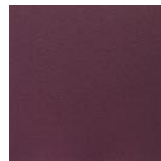

Plum

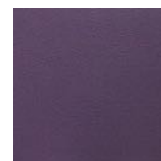

Purple Iris



Raspberry

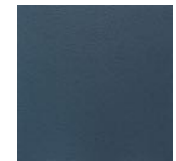

Regimental Blue



Rose



Royal

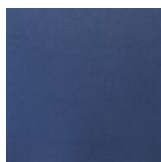

Royal Blue

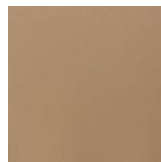

Saddle Tan



Sand

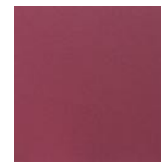

Sangria

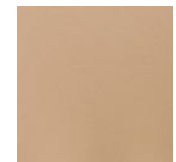

Shell

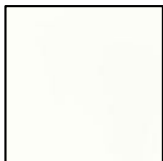

Snow White

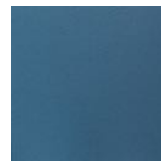

Space Blue



Sun Yellow



Super White

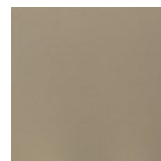

Taupe

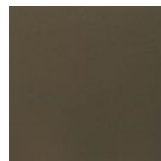

Tea Leaf

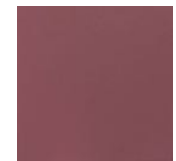

Tea Rose



Teal



Toast

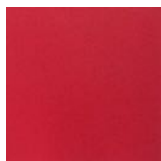

Tomato



Vizcaya Palm

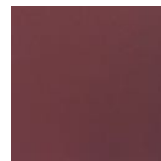

Wine Berry



Wood Violet

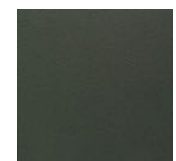

Yew Green

STANDARD – VINYL & FABRIC

STANDARD – FABRIC – Mayer, Forte



Aspen



Avocado



Blue Ray



Cadet



Char



Chive

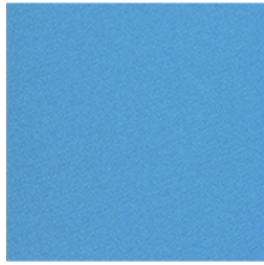

Cosmo



Crocus



Daffodil



Fairway



Flint



Fudge



Neptune



Pimento



Port



Pumice



Rouge



Sable



Slate



Smoke



Squash

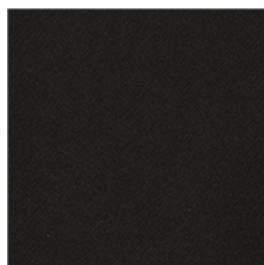

Tuxedo

STANDARD – VINYL & FABRIC

STANDARD – FABRIC – Mayer, Cross Check

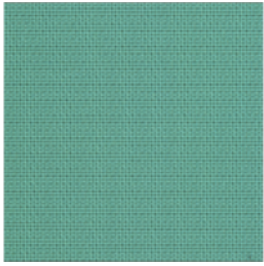

Aquamarine



Basalt



Blue Ribbon

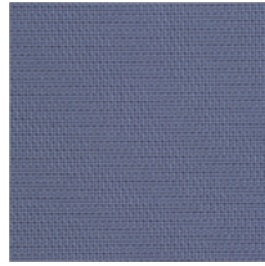

Concord



Cranberry

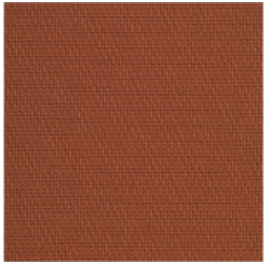

Demerera



Dove



Earth

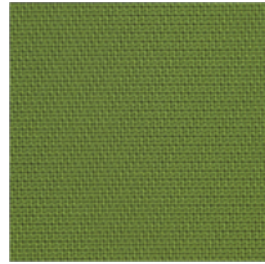

Evergreen

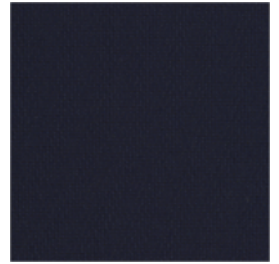

Imperial

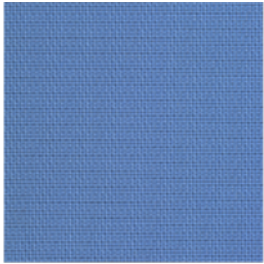

Lapis

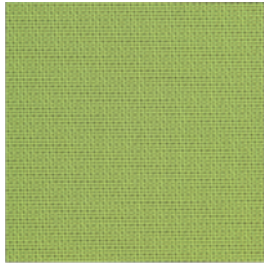

Lime

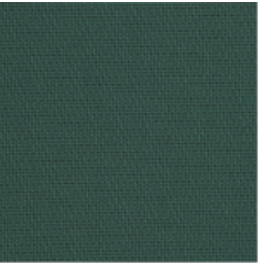

Malachite

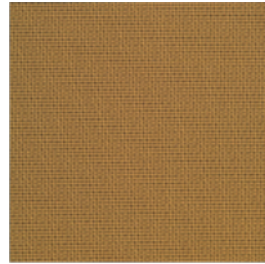

Maple



Marine



Martinique

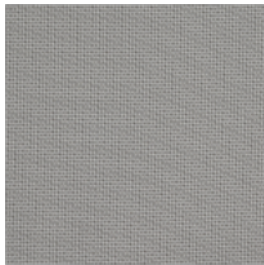

Mercury



Midnight



Otter



Paradise



Platinum

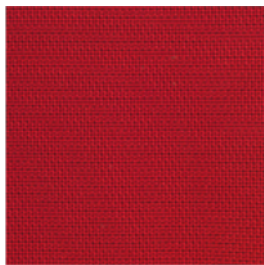

Red Baron



Saddle Tan



Slate Black



Vermillion

GRADE 1 – VINYL & FABRIC

GRADE 1 – VINYL – Spradling, Patriot Plus II

						
8501 Adobe White	8504 Sand	8506 Putty	8614 Salsa	8516 Chestnut	8517 Mocha	8528 American Beauty
						
8529 Paprika	8532 Bordeaux	8533 Port	8539 Gunmetal	8540 Black	8541 Space Blue	8542 Royal
						
8544 Sapphire	8546 Colonial Blue	8547 Midnight Blue	8553 Yew Green	8560 Aqua Grey	8561 Mulberry	8564 Grotto
						
8567 Dove	8569 Burgundy	8571 Forest	8572 Blueridge	8576 Deep Phoenician	8577 Purple Grey	8579 Ruby
						
8581 Dark Aqua	8582 Imperial Blue	8584 Taupe	8602 Oatmeal	8603 Lark	8604 Concrete	8605 Charcoal
						
8628 Sea	8626 Eucalyptus	8625 Cypress	8610 Sable	8611 Terra Cotta	8624 Granny Smith	8613 Orange Kist
						
8615 Berry	8617 Aubergine	8620 Peacock	8623 Sage			

GRADE 1 – VINYL & FABRIC

GRADE 1 – VINYL – Spradling, Whisper



2117
Bone



2118
Camel



2119
Gravel



2120
Antelope



2121
Cappuccino

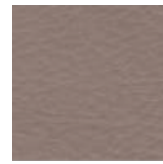

2150
Fawn



2123
Luggage



2124
Salsa



2125
Cinnamon



2126
Bordeaux



2127
Merlot

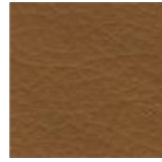

2151
Ochre



2129
Forest



2152
Mahogany



2153
Truffle



2154
Pewter



2155
Storm

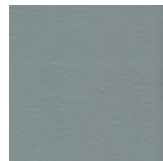

2134
Patina

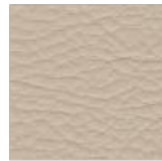

2156
Putty



2136
Cerulean

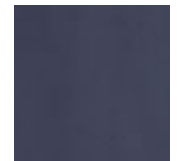

2137
Navy

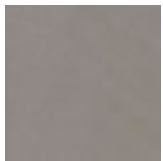

2138
Elephant



2139
Charcoal



2140
Black



2141
Cashew



2142
Cognac



2143
Espresso



2144
Sangre



2157
Fog

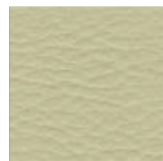

2158
Cucumber



2159
Zest



2160
Sassafras



2161
Mallard



2162
Paradise



2163
Indigo



2164
Carotene



2165
Molten

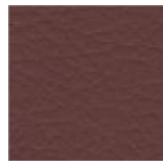

2166
Brick Red

GRADE 1 – VINYL & FABRIC

GRADE 1 – FABRIC – Mayer, Artistry

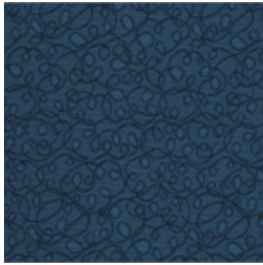

Atlantic

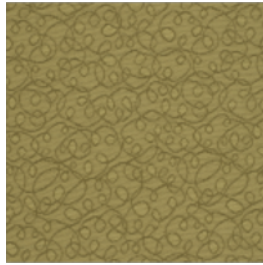

Celadon



Cornsilk



Graphite

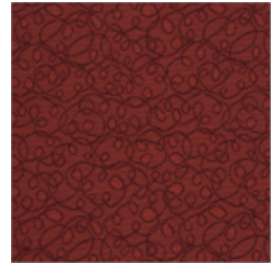

Paprika



Parchment



Tangerine

GRADE 1 – FABRIC – Mayer, Banner



Buttercream

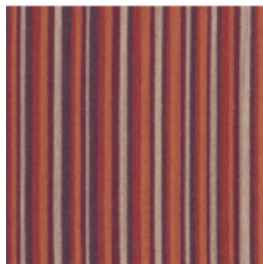

Cranberry



Fiesta



Granite



Meadow



Shoreline

GRADE 2 – VINYL & FABRIC

GRADE 2 – VINYL – Spradling, Silvertex



Marine Blue



Lagoon



Turquoise



Sapphire



Jet

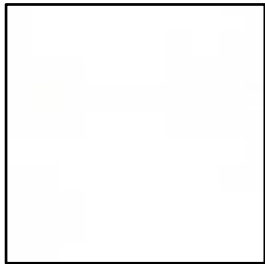

Ice

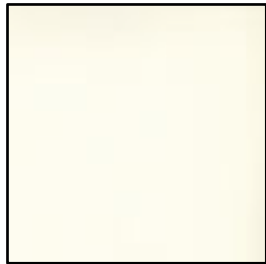

Cream



Champagne

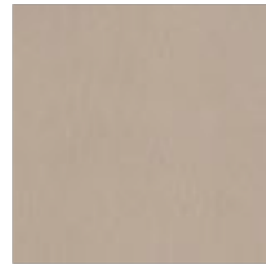

Taupe



Chestnut

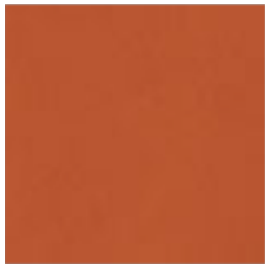

Mandarin



Sunkist

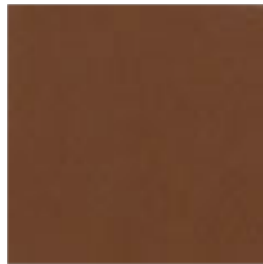

Luggage

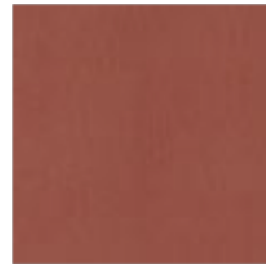

Umber



Borscht



Raspberry



Blackberry



Sage



Celery



Basil



Bottle



Storm

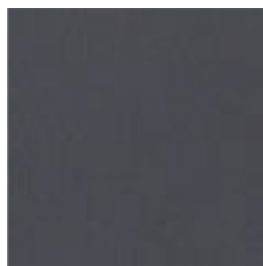

Carbon

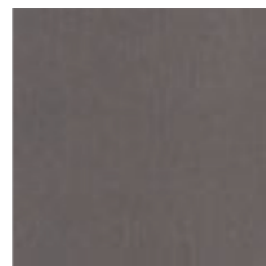

Meteor



Mocha

GRADE 2 – VINYL & FABRIC

GRADE 2 – VINYL – Spradling, Savoy II



Bayleaf



Burgundy

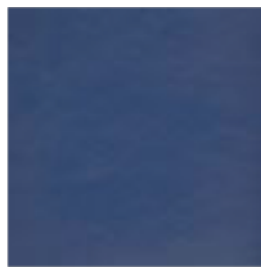

Delta Blue



Spanish Rose



Tallow



Eucalyptus



Toffee



Black

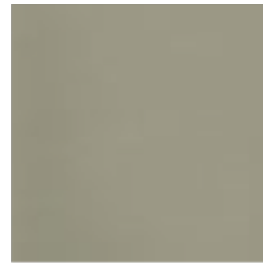

Desert Sage



Dove Grey

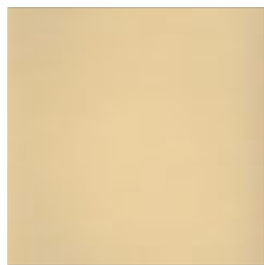

White Gold



Aubergine

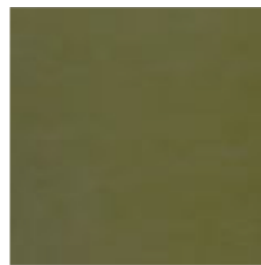

Cypress

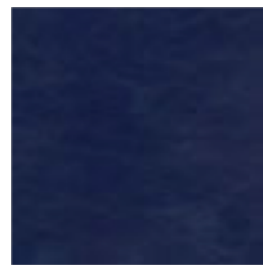

Navy



Carob

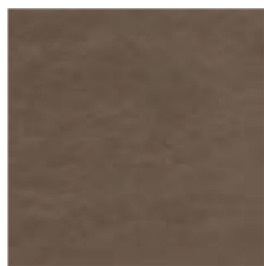

Mink

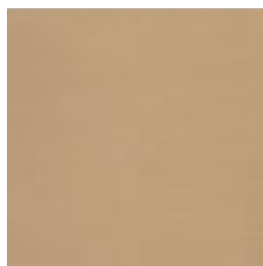

Doe

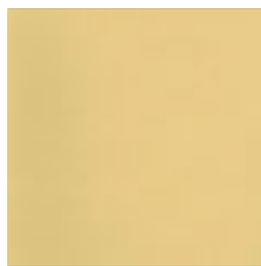

Sisal

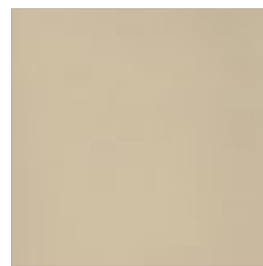

Mist



Curry

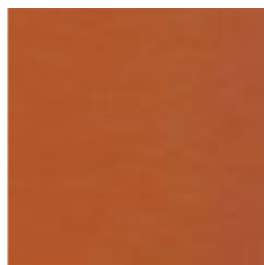

Tumeric

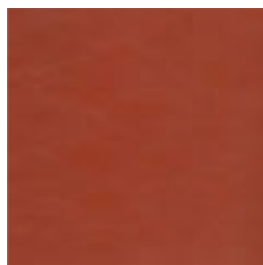

Copper Clay

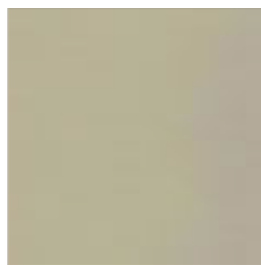

Fog

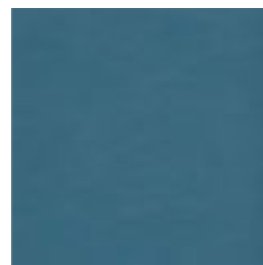

Blue Tide



Deep Royal

GRADE 2 – VINYL & FABRIC

GRADE 2 – VINYL – Spradling, Stratosphere



Turquoise



Concrete



Charcoal



Ice Blue



Mystic Blue



Cobalt



Grass



Copper



Pumpkin



Poppy



Bordeaux



Taupe



Moss



Bronze



Espresso

GRADE 2 – VINYL & FABRIC

GRADE 2 – VINYL – Kilkenny Tweed



Stone



Curry

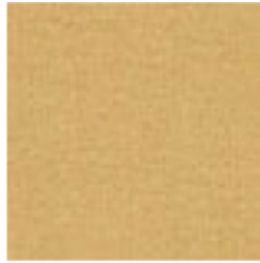

Sisal



Bittersweet



Clay Pot



Briar



Apple Tart



Brite Light



Charcoal



Burlap



Khaki



Evergreen



Ice



Nightshade



Spruce



Celery

GRADE 2 – VINYL & FABRIC

GRADE 2 – FABRIC – Mayer, Quattro



Chalk



Dark Orchid



Deep Crimson

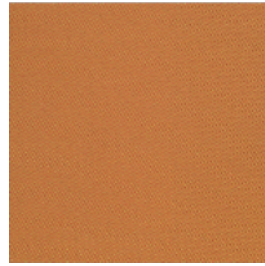

Golden Orange



Granite



Hibiscus



Honeycomb



Khaki



Laguna



Mercury



Midnight Blue



Olive

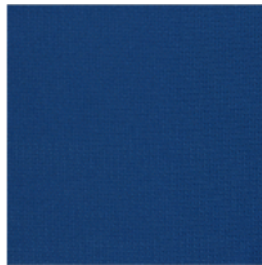

Skyway



Spring Green



Umber



Wheat

GRADE 2 – VINYL & FABRIC

GRADE 2 – VINYL – Spradling, Dolce



GRADE 2 – VINYL & FABRIC



Grass



Meteor



Black

GRADE 2 – FABRIC – Mayer, Align



Cardinal



Chrysalis

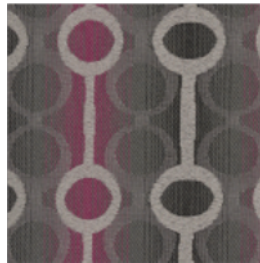

Cyberspace



Fruit Punch



Honeycomb



Java



Limeade



Moody Blue



Oasis



Sea Salt



Tattoo

GRADE 2 – VINYL & FABRIC

GRADE 2 – FABRIC – Mayer, Batik



Ablaze

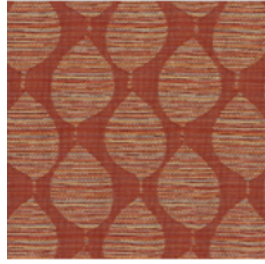

Amber



Bamboo

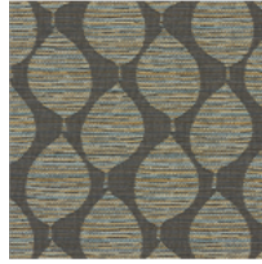

Blue Clay



Cyberspace



Ember



Jungle



Limeade

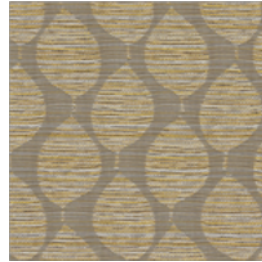

Sandalwood

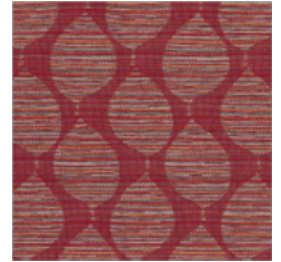

Sangria



Seaworthy

GRADE 2 – FABRIC – Mayer, Component



Bronze

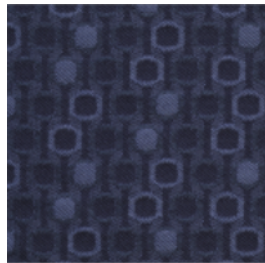

Cobalt



Copper



Limelight



Moonbeam

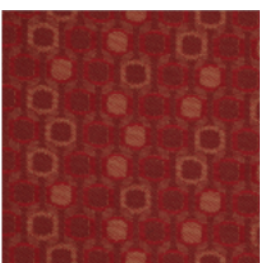

Ruby

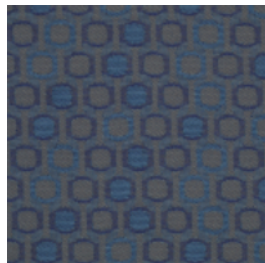

Sky

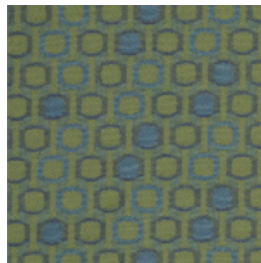

Turquoise

GRADE 2 – VINYL & FABRIC

GRADE 2 – FABRIC – Mayer, Broadway

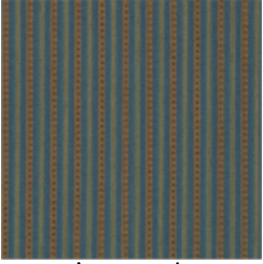

Aquamarine

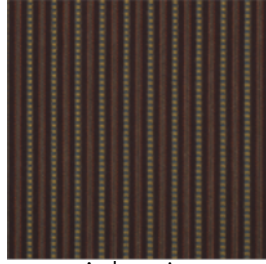

Aubergine



Caramel

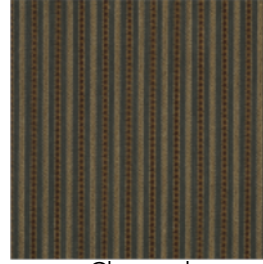

Charcoal



Ecreu



Green Tea

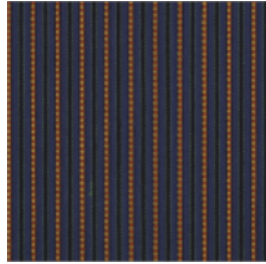

Indigo



Mist

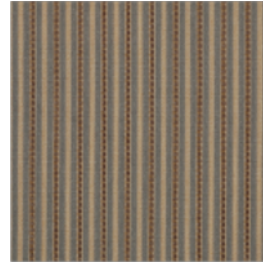

Pewter

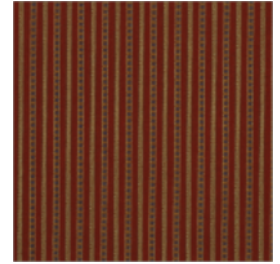

Pomegranate

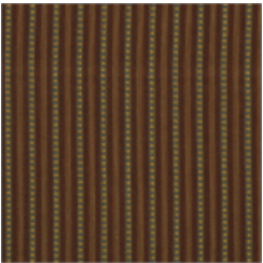

Sable

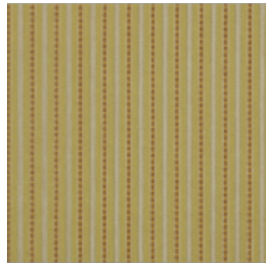

Wasabi

GRADE 2 – FABRIC – Mayer, Equation



Amber

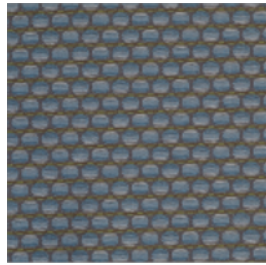

Aquamarine



Bronze



Dusk

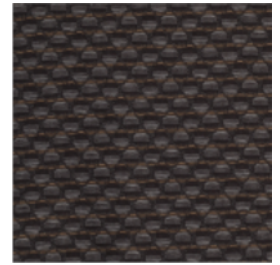

Ebony



Indigo

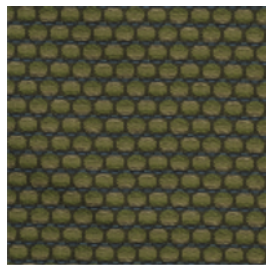

Jade

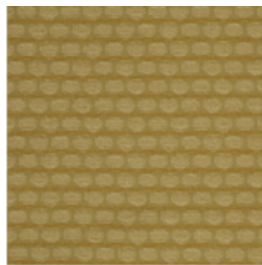

Limelight



Rosewood



Russet

GRADE 2 – VINYL & FABRIC

GRADE 2 – FABRIC – Mayer, Catalyst

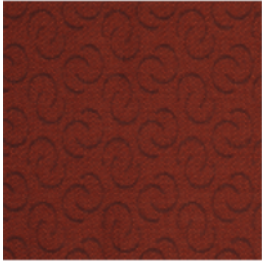

Amber



Bronze



Copper



Denim



Dusk

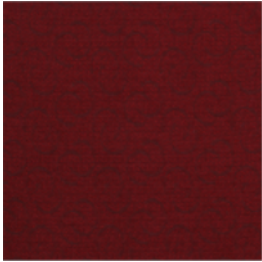

Garnet

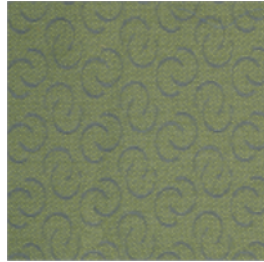

Jade



Lapis



Limelight

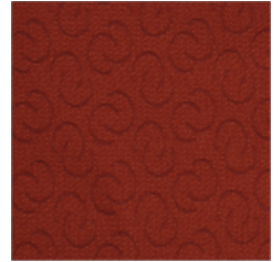

Rouge



Slate



Steel



Taupe



Teal

GRADE 2 – FABRIC – Mayer, Essex



Alabaster

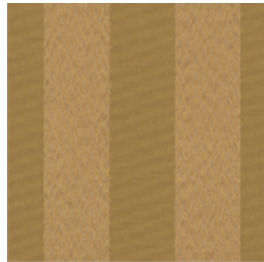

Chamois



Garnet

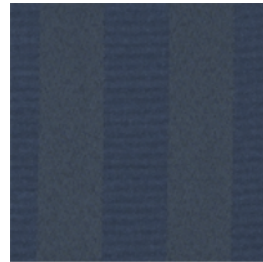

Indigo



Lawn

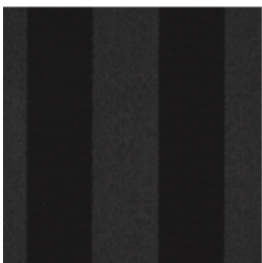

Obsidian



Paprika

GRADE 2 – VINYL & FABRIC

GRADE 2 – FABRIC – Mayer, Destiny



Azure



Beachcomber



Bronze

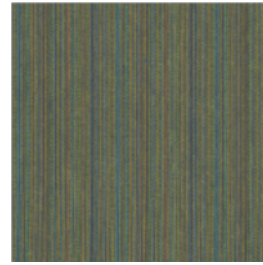

Capri

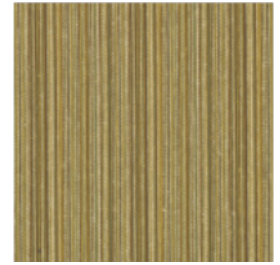

Celadon

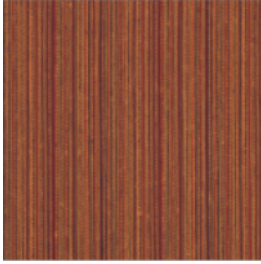

Fiesta



Granite

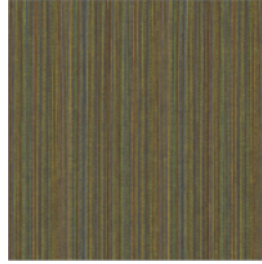

Meadow

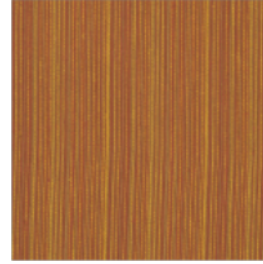

Pumpkin

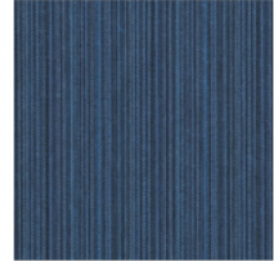

Sapphire

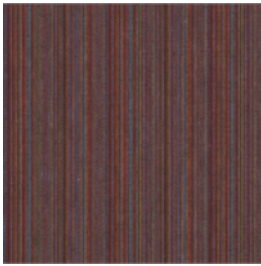

Wildberry

GRADE 2 – FABRIC – Mayer, Figure Eight



Azure



Buff



Ebony

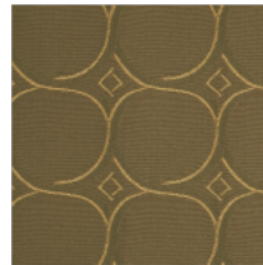

Feldspar



Lavender



Marigold

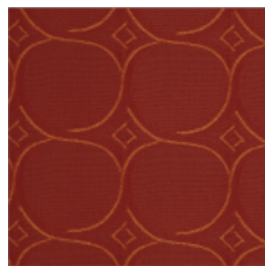

Pomegranate



Stormy Weather

GRADE 2 – VINYL & FABRIC

GRADE 2 – FABRIC – Mayer, Entwine

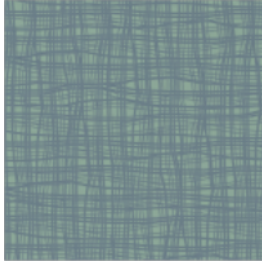

Aquamarine

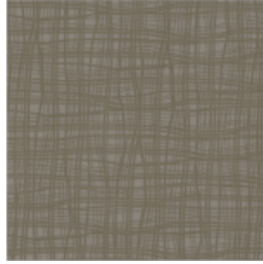

Bark

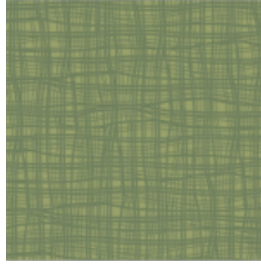

Basil



Cocoa



Grey Mist

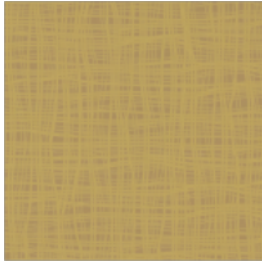

Maize

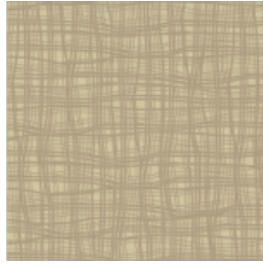

Natural



Parchment

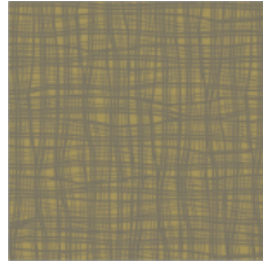

Patina



Pomegranate

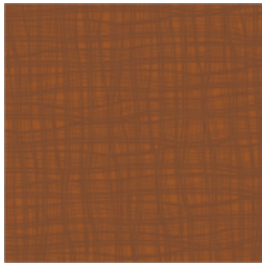

Saffron

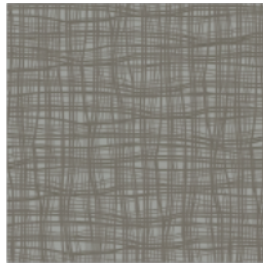

Shadow

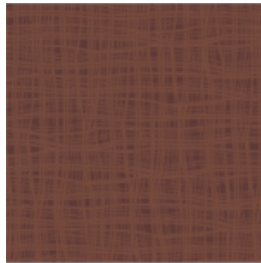

Sunset

GRADE 2 – FABRIC – Flower Power



Crimson



Ecru

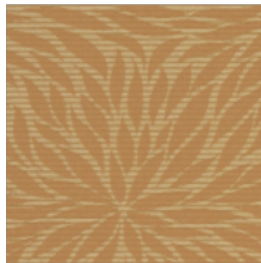

Gold



Jade



Periwinkle



Sapphire



Shadow



Taupe

GRADE 3 – VINYL & FABRIC

GRADE 3 – FABRIC – Mayer, Dazzle

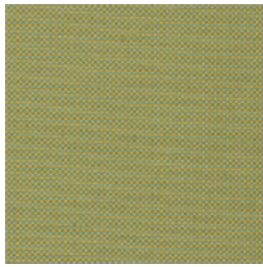

Aloe

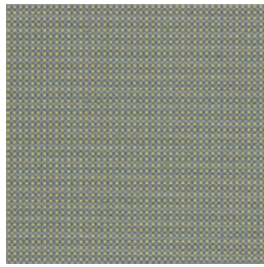

Aquamarine

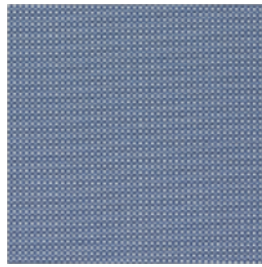

Azure

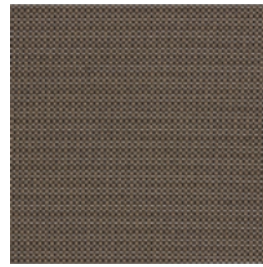

Bark

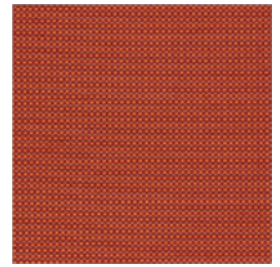

Cinnabar

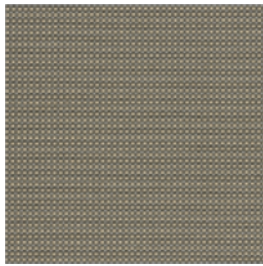

Greystone

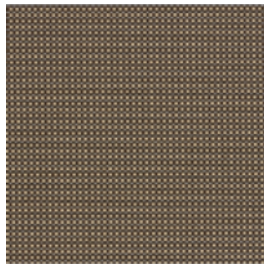

Java

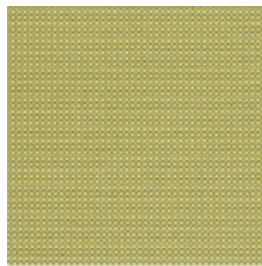

Limelight

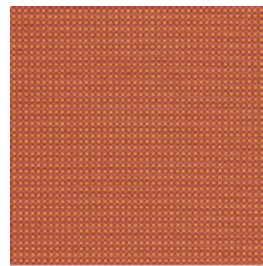

Melon

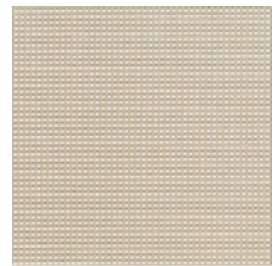

Parchment



Quartz

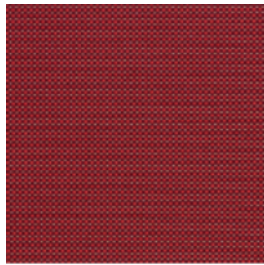

Ruby

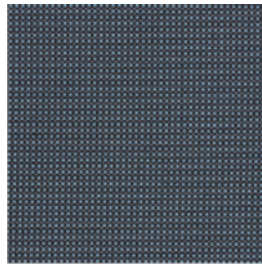

Sapphire

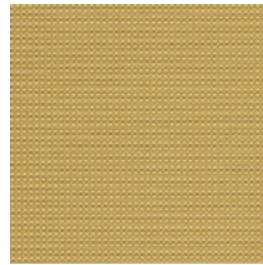

Sunflower

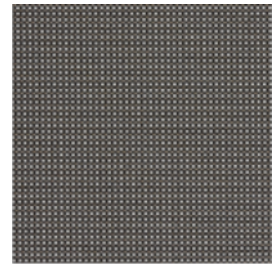

Titanium

GRADE 3 – FABRIC – Mayer, Detail

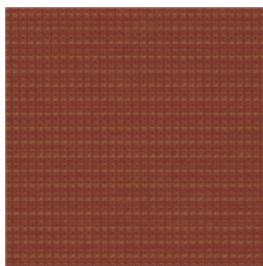

Bittersweet

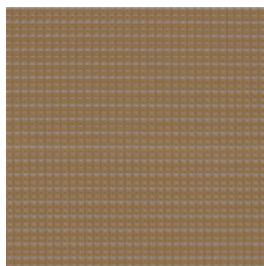

Butterscotch

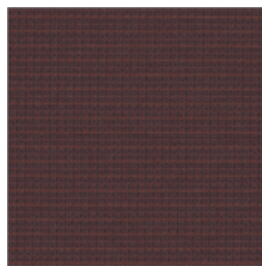

Cabernet

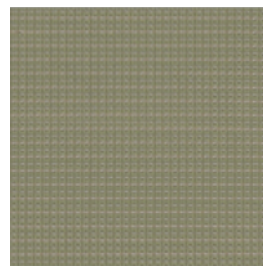

Celadon

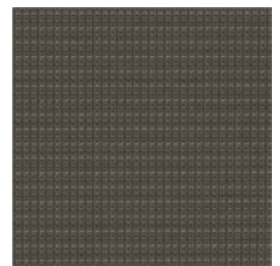

Granite

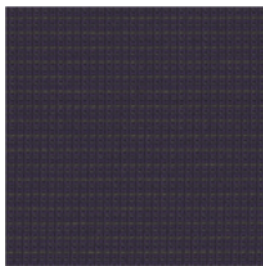

Grape

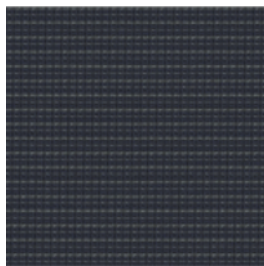

Indigo

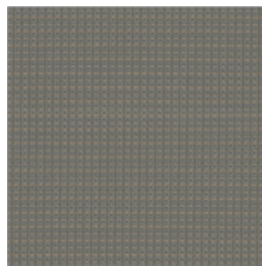

Spa



Taupe

GRADE 3 – VINYL & FABRIC

GRADE 3 – FABRIC – Mayer, Echo



Abalone



Apple Green

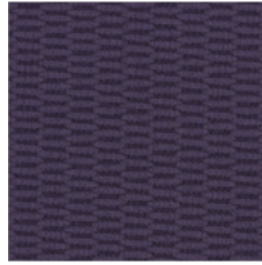

Aubergine

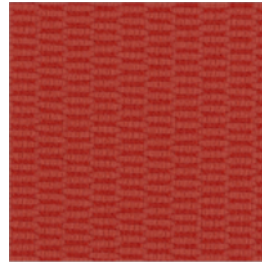

Blaze

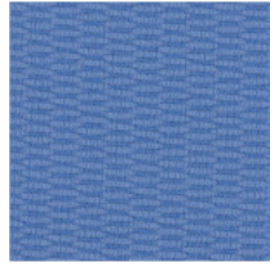

Cerulean

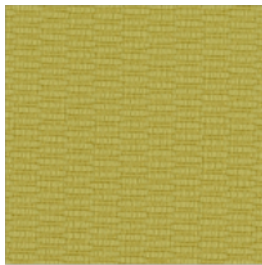

Chrome Yellow

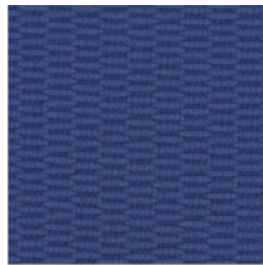

Cobalt

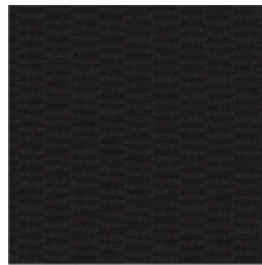

Ebony

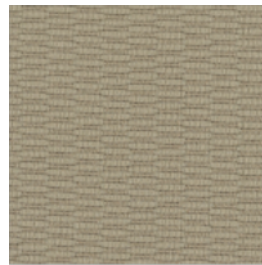

French Beige

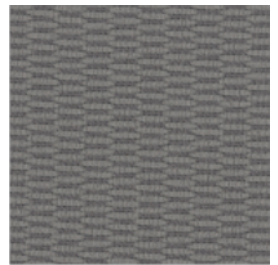

Greystone

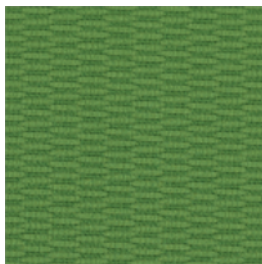

Kelly Green

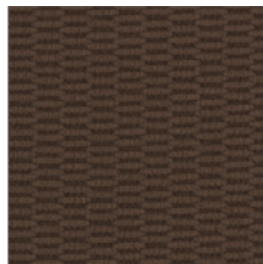

Sable

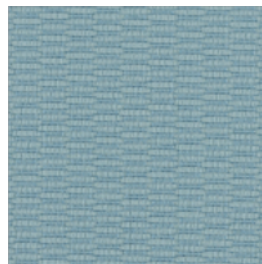

Skylight

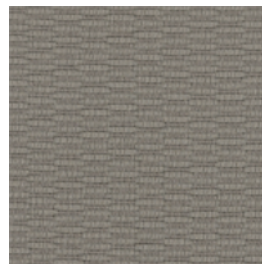

Smokey Taupe



Turquoise

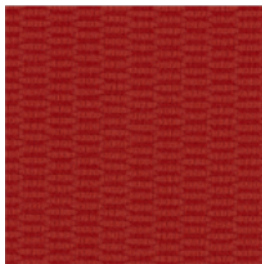

Vermillion

GRADE 3 – VINYL & FABRIC

GRADE 3 – FABRIC – Mayer, Equinox



Alabaster

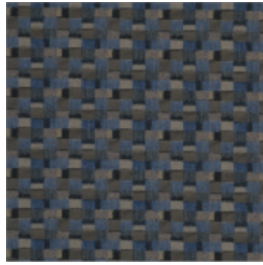

Cobalt

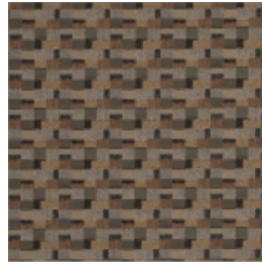

Earth

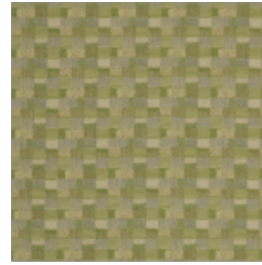

Feldspar

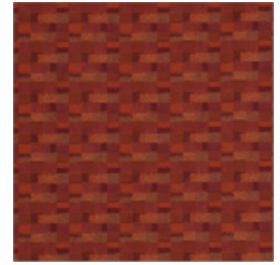

Fire

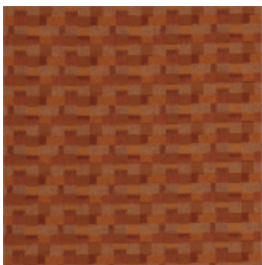

Russet



Smoke

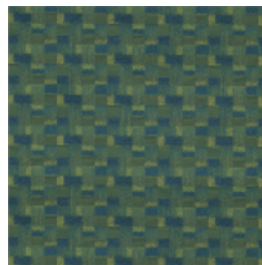

Turquoise

GRADE 3 – FABRIC – Mayer, Europa

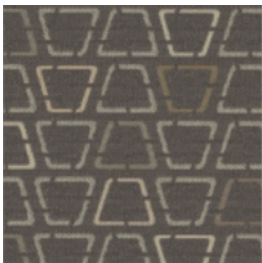

Charcoal

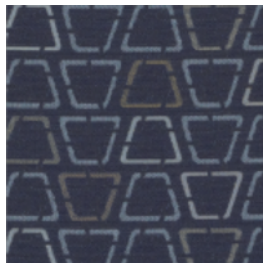

Cobalt



Earth

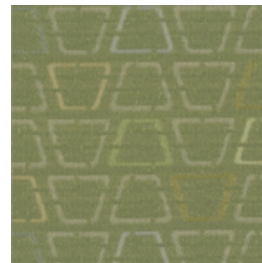

Feldspar



Fire



Sand

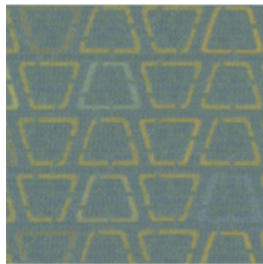

Turquoise

GRADE 3 – VINYL & FABRIC

GRADE 3 – FABRIC – Mayer, Burst

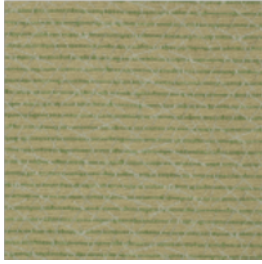

Celadon

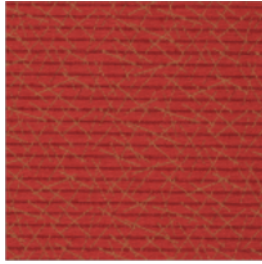

Crimson

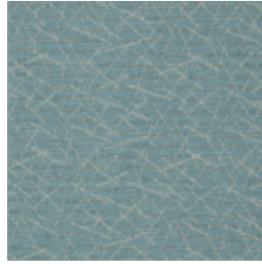

Cyan

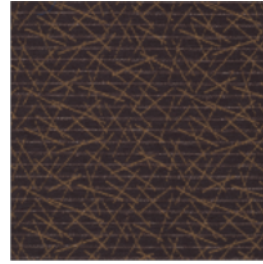

Ebony



Pewter

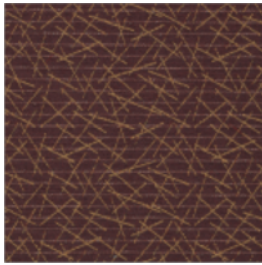

Raisin



Topaz

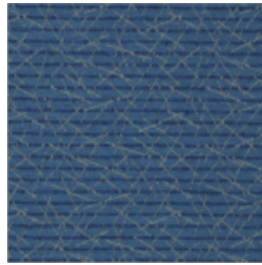

Ultramarine

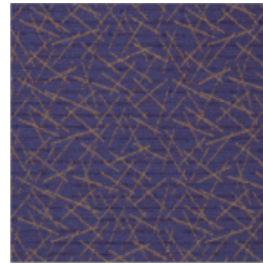

Violet

GRADE 4 – VINYL & FABRIC

GRADE 4 – FABRIC – Mayer, Avenue

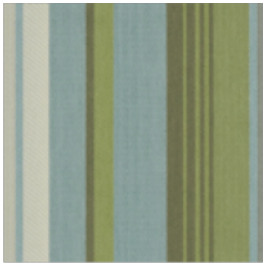

Aloe



Aquamarine



Cardinal



Dijon



Granite



Mimosa

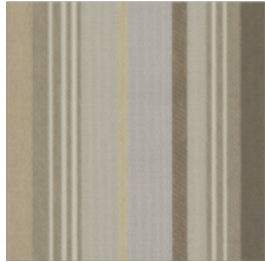

Mushroom



Sunset



Topaz



Vineyard

GRADE 4 – FABRIC – Encore



Bittersweet

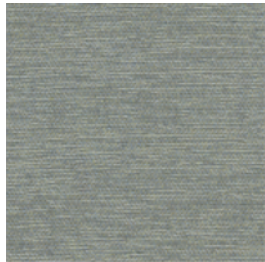

Cerulean



Chiffon



Cyan



Ebony



Flame

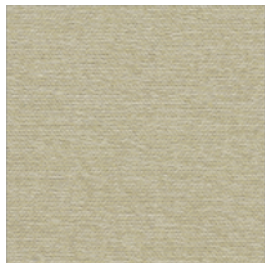

Flax



Forest



Haze



Ivory



Laurel



Pomegranate



Sapphire



Stone



Wasabi

GRADE 4 – VINYL & FABRIC

GRADE 4 – FABRIC – Mayer, Bungalow

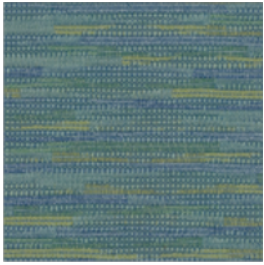

Blue Nile

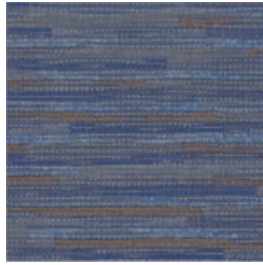

Blue Stone



Curry



Ecru



Granite



Lavender



Opal

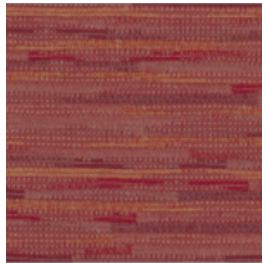

Rouge



Shitake

GRADE 4 – FABRIC – Mayer, Charade

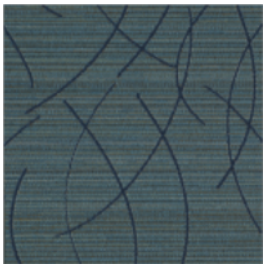

Cerulean



Flax



Forest



Mango



Opal



Raffia

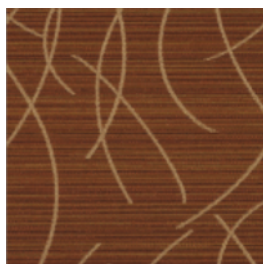

Rust



Stone



Vermillion

GRADE 5 – VINYL & FABRIC

GRADE 5 – FABRIC – Mayer, Circuit



Aloe

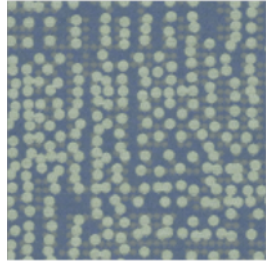

Aquamarine

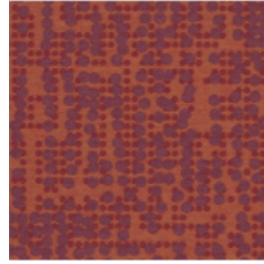

Bittersweet

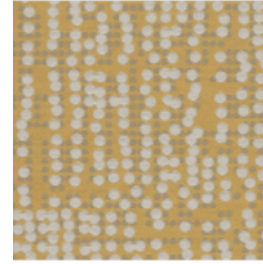

Butterscotch

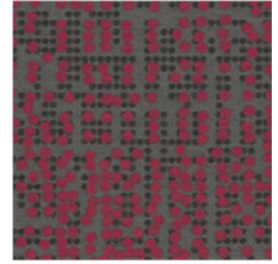

Cardinal

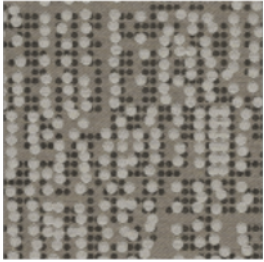

Granite

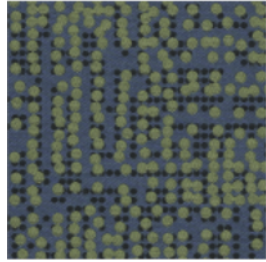

Indigo

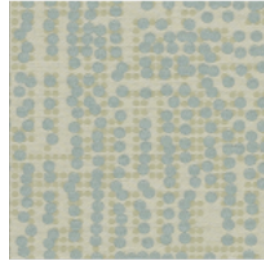

Spa

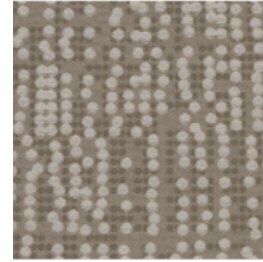

Taupe

GRADE 5 – FABRIC – Mayer, Circumference

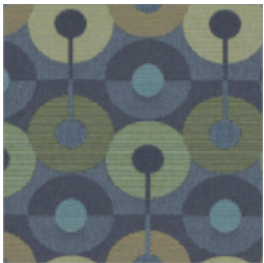

Aquamarine



Blue Skies



Granite

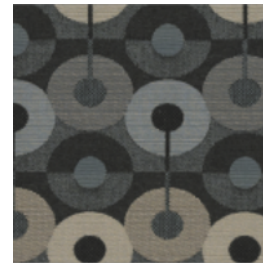

Midnight



Natural



Sable



Tarragon



Turquoise

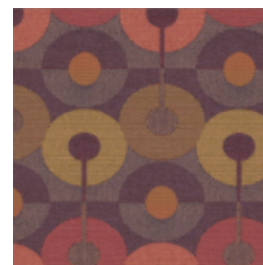

Vineyard



Wisteria

GRADE 4 – FABRIC – Mayer, Fantasy

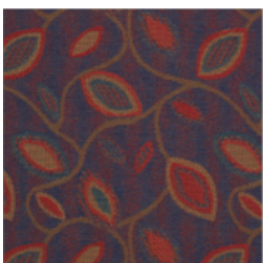

Cloak



Green Tea



Harvest

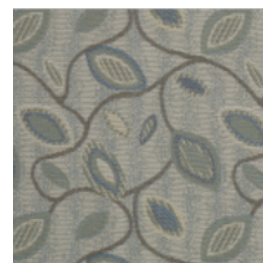

Ice Blue



Sangria

GRADE 5 – VINYL & FABRIC

GRADE 5 – FABRIC – Mayer, Ascension



Celadon

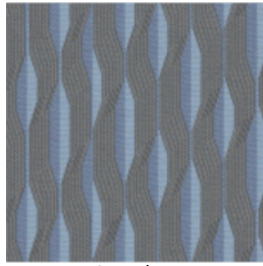

Cerulean

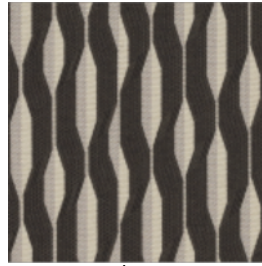

Ebony

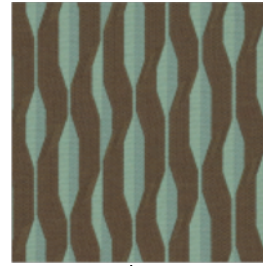

Eucalyptus



Lemon Drop



Limelight



Rouge



Spice



Stone

GRADE 5 – FABRIC – Mayer, Aurora

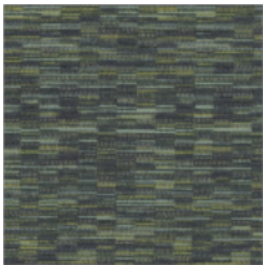

Emerald



Granite



Midnight



Olive



Opal

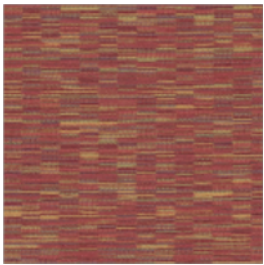

Poppy

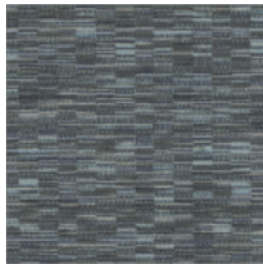

Sky



Slate



Stone



Wheat



Wisteria

GRADE 5 – VINYL & FABRIC

GRADE 5 – FABRIC – Mayer, Collage

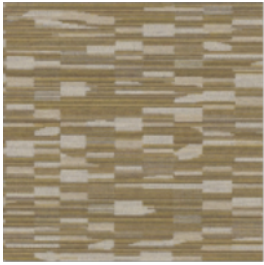

Bronze

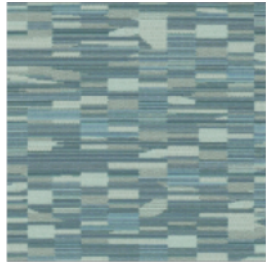

Cerulean

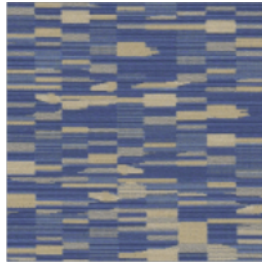

Cobalt

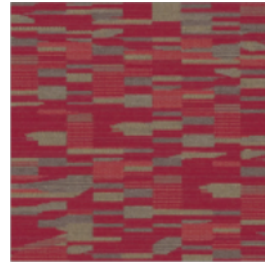

Crimson

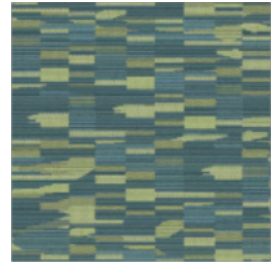

Emerald

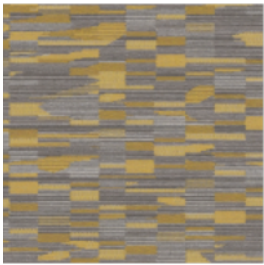

Goldenrod

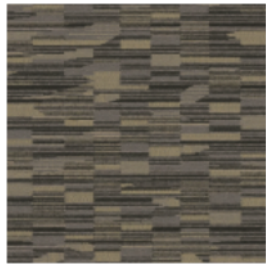

Granite

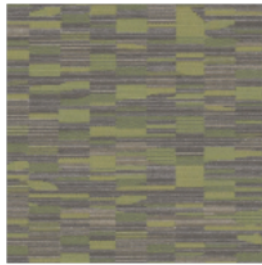

Jade

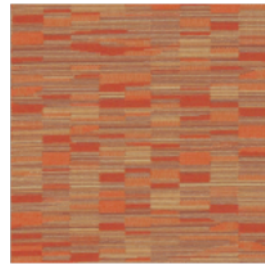

Tiger Lily

GRADE 5 – VINYL & FABRIC

GRADE 5 – FABRIC – Mayer, Canvas

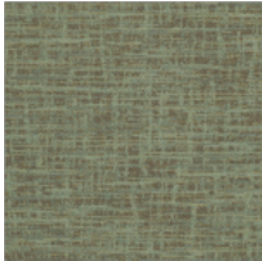

Bittermint

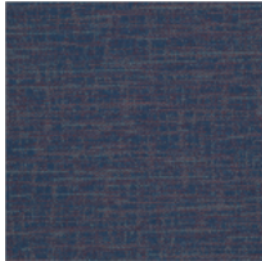

Boysenberry



Bronze



Cliff



Flax



Green Tea



Obsidian

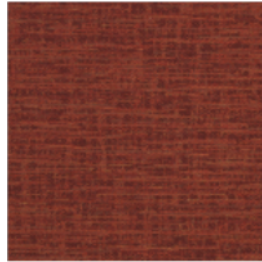

Paprika



Spa



Spice

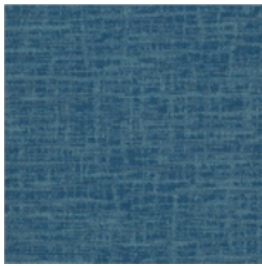

Stream

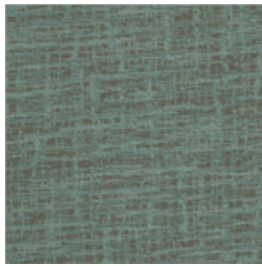

Turquoise

TABLE EDGE FINISH SPECIFICATIONS

EDGE STYLES

Vinyl Edges

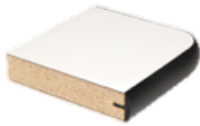

L-15
1/4" x 1-1/4" Bullnose vinyl
t-mold edge. 1" radius
corners.



L-21
1/4" x 1-1/4" Flat vinyl t-
mold edge. 1" radius
corners.

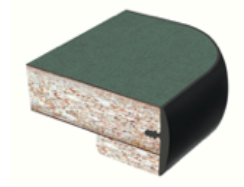

L-23
1/4" x 1-3/4" Bullnose vinyl
t-mold edge. 1" radius
corners.

PVC/Self Edges



P-10
Self Edge (1 Year Warranty)

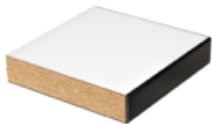

P-14
3mm x 1-1/4" Flat PVC
edge. 1/8" radius corners
& edges. Specialty edge.



PK-4
PVC Reverse Knife Edge 4
sides 3mm x 1-1/4" Flat
rigid PVC. 1/8" radius
corners & edges.

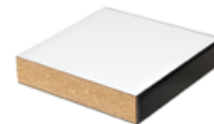

P-12
3mm x 1-1/4" Flat PVC
edge. 1/8" radius corners
& edges.



PK-2
PVC Reverse Knife Edge 2
sides 3mm x 1-1/4" Flat
rigid PVC. 1/8" radius
corners & edges.



LC-9
2" x 1-1/4" Comfort Eased
front edge with 3mm x 1-
1/4" Flat rigid P12 Black
Ebony PVC on remaining 3
edges. 1/8" radius corners
& edges.

EDGE STYLES

Urethane Edges



MR-1
1-1/4" x 1-1/4" Full
Bullnose soft molded edge.
3/4" radius corners.



MR-2
1-1/4" x 1-1/4"
Rectangular soft molded
edge. 3/4" radius corners,
3/16" radius edges.



MR-6
1-1/4" x 1-1/4" Waterfall
soft molded edge. 3/4"
radius corners.

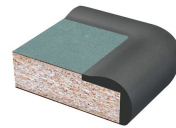

MA-2
1-1/2" x 1-1/4" Deluxe No-
Spill soft molded edge. 1-
1/2" radius corners.

Textured Edges

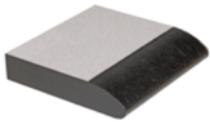

TC-9
2" x 1-1/4" comfort eased
front edge with textured
nish with remaining 3 sides
PVC. 1/8" radius corners
and edges.

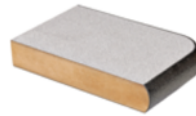

T-15
1/8" x 1-1/4" Bullnose
textured edge. 1" radius
corners. **Only available in
E06 and E10 colors.**

Resin Edges



R-1
3/4" x 1-1/4" Full Bullnose
rainbow resin edge. Square
corners.



R-2
1/4" x 1-1/4" Flat rainbow
resin edge. Square corners.



R-5
3/4" x 1-1/4" Beveled
rainbow resin edge. Square
corners.



R-6
3/4" x 1-1/4" Waterfall
rainbow resin edge. Square
corners.



R-7
1-1/4" x 1-1/4" Bullnose
No-spill rainbow resin
edge. Square corners.



R-9
1/4" x 1-1/4" Knife rainbow
resin edge. Square corners.



RK-2
Acrylic Resin Reverse Knife
Edge on 2 Sides. 1/8"
radius corners and edges.



RK-4
Acrylic Resin Reverse Knife
Edge on 4 Sides. 1/8"
radius corners and edges.

EDGE STYLES

Wood Edge/Laminate Surface (W) & Wood Edge/Veneer Surface (V)



W-12 & V-12
3mm x 1-1/4" Flat wood edge (Framed Style/Lap Joint). Square corners, edges eased.



W-16 & V-16
1-1/4" x 1-1/4" Flat wood edge. 1/4" radius corners and edges.



W-17 & V-17
1-1/4" x 1-3/4" Flat wood edge. 1/4" radius corners and edges.



W-18 & V-18
1-1/4" x 1-1/4" Full Bullnose wood edge. 1" radius corners.



W-19 & V-19
1-1/4" x 1-3/4" Full Bullnose wood edge. 1" radius corners.



W-23 & V-23
1-1/4" x 1-1/4" Waterfall wood edge. 1/4" radius corners, edges eased.



W-32 & V-32
1-1/4" x 1-3/4" Fluted wood edge. Square corners, edges eased.

Solid Surface



Bullnose

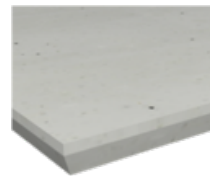

Knife



Eased



Waterfall

STANDARD EDGE COLORS

T-Mold Edge Colors



P-12 PVC Edge Colors



STANDARD EDGE COLORS

P-14 Specialty PVC Edge Colors



E18 - Aluminum



E21 - Solar Oak



E22 - Nepal Teak

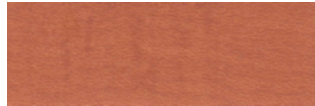

E23 - Huntington Maple



E24 - Asian Night



E25 - Brazilwood

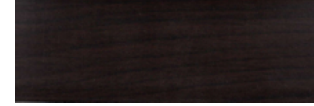

E26 - Cafelle



E27 - Columbian Walnut

Wood Edge Colors

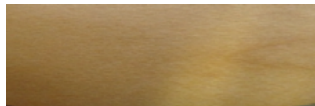

MA1 - Natural Maple



MA2 - Honey Maple



MH1 - Natural Mahogany



OK1 - Natural Red Oak

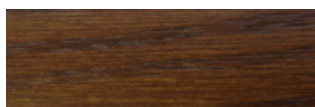

OK2 - Medium Oak

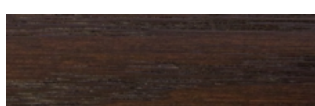

OK3 - Dark Oak

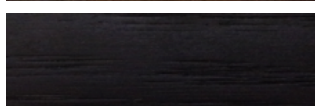

OK4 - Black Oak

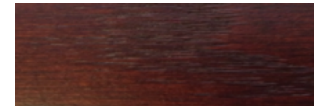

OK7 - Mahogany Oak



CH1 - Natural Cherry

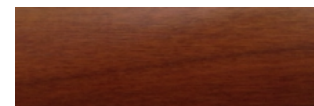

CH2 - Golden Cherry

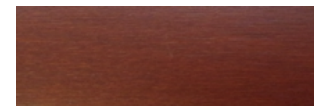

CH3 - Dark Cherry

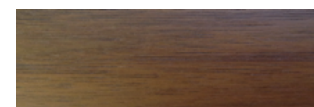

WT1 - Natural Walnut

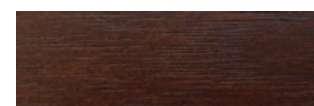

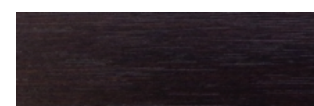

WT2 - Dark Walnut



WT3 - Espresso Walnut

STANDARD EDGE COLORS

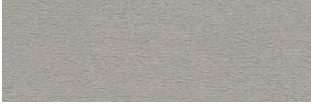
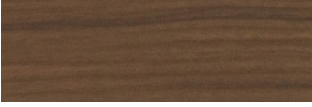
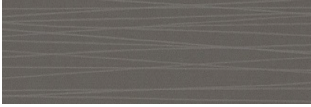
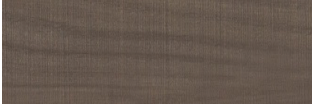
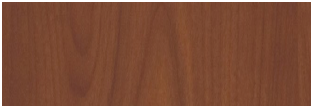

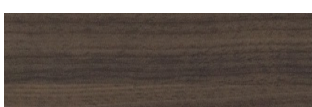
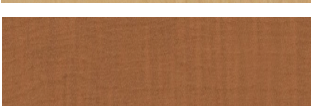
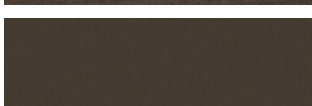
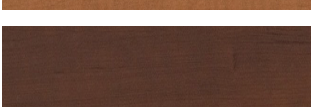
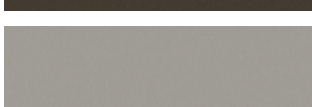
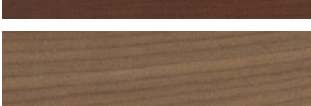
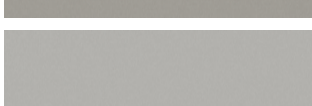
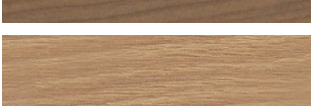
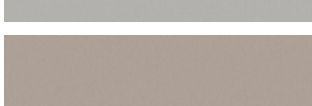
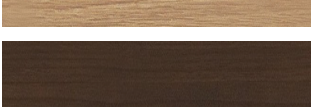
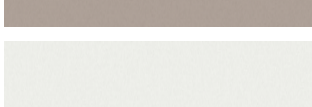
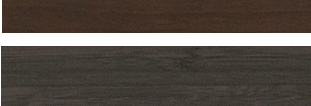
1MM PVC EDGE COLORS – CORE & CORE SEATING ONLY

	4830-18 Satin Stainless		7965-12 Walnut Heights
	4941-18 Cosmic Strandz		7966-12 5 th Ave Elm
	7054-60 Wild Cherry		7970-18 High Line
	7909-60 Fusion Maple		7993-38 Florence Walnut
	7929-38 Huntington Maple		D91-60 Slate Grey
	7935-07 Shaker Cherry		D92-60 Dove Grey
	7937-38 River Cherry		D315-60 Platinum
	7938-38 New Age Oak		D327-60 Pepperdust
	7943-07 Columbian Walnut		D354-60 Designer White
	7949-18 Asian Night		





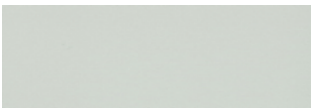



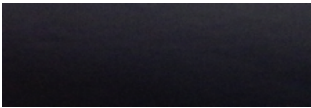

STANDARD TABLE BASE FINISH SPECIFICATIONS

STANDARD TABLE BASE FINISHES

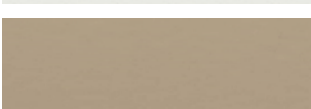
Textured Finishes

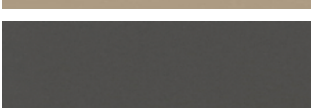
	T01 - Quartzite		T09 - Grazor
	T02 - Speckled Salt		T12 - Battleship Grey
	T03 - Shubi Oxide		T13 - Blue Montrose
	T04 - Dusty Ash		T16 - Charcoal Wrinkle
	T05 - Black Wrinkle		T17 - Platinum Wrinkle
	T06 - Brown Wrinkle		T18 - Silver Texture
	T07 - Winter Sky		T22 - Silver Sparkle
	T08 - Wahelo Red		

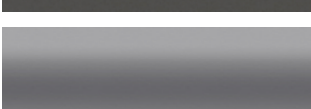
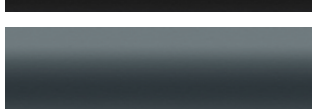
Smooth Finishes

	S10 - Ebony		S20 - Monument Grey
	S11 - Snow		S21 - Tranquil
	S14 - Cappuccino		S22 - Carmello
	S15 - Graphite		S23 - Jet Black
	S18 - Grey Luster		S24 - Maritime
	S19 - Mink		S25 - Patriot Blue

STANDARD TABLE BASE FINISHES

Smooth Finishes (continued)



S26 - Bonzai



S27 - Nutmeg



S28 - Dusk



S29 - Sky Grey



S30 - Bittersweet



S31 - Signature Purple



S32 - Wasabi



S43 - Brass



S44 - Industrial

Metallic Finishes

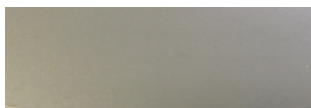

M24 - Chrometal

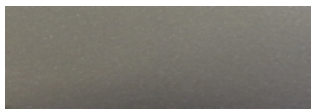

M33 - Titanium

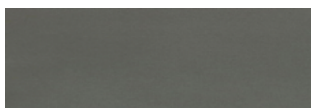

M34 - Pewter

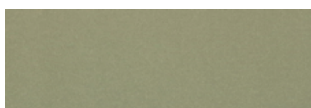

M35 - Champagne

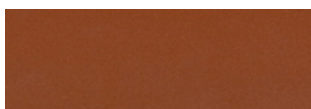

M36 - Cinnamon Sparkle



M37 - Volcanic Bronze

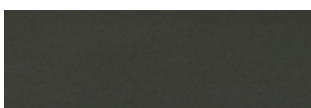

M38 - Gunmetal

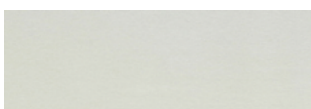

M39 - Moonlit Silver*



M40 - Oyster Pearl

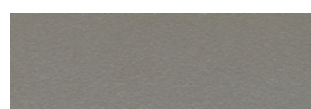

M41 - Pumice Stone

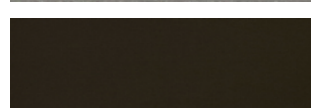

M42 - Pyrite

* Upcharge Applies

STANDARD TABLE BASE FINISHES

Chrome Finishes



C10 – Bright Chrome*

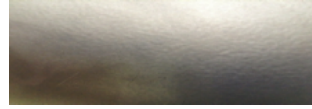

C29 – Satin Chrome*



C40 – Brushed Steel*

* Upcharge Applies

WOOD FINISH SPECIFICATIONS

STANDARD WOOD FINISH COLORS



MA1 – Natural Maple



MA2 – Honey Maple



MH1 – Natural Mahogany



OK1 – Natural Red Oak



OK2 – Medium Oak

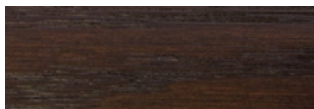

OK3 - Dark Oak



OK4 – Black Oak



OK7 – Mahogany Oak

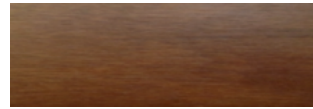

CH1 – Natural Cherry

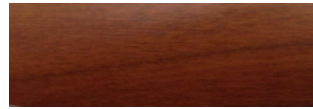

CH2 – Golden Cherry

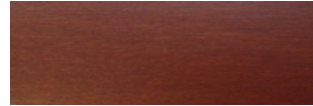

CH3 – Dark Cherry

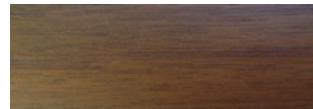

WT1 – Natural Walnut

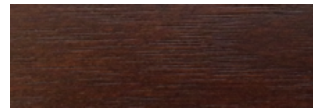

WT2 – Dark Walnut

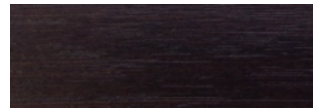

WT3 – Espresso Walnut

KRYCOAT PAINT FINISH SPECIFICATIONS

STANDARD KRYCOAT WOOD FINISHES



Space Black



Himalayan Trek



Silent Night



Baltic Grey



Night Horizon

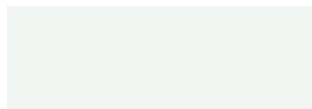

White

STANDARD RESIN FINISH SPECIFICATIONS

STANDARD RESIN FINISHES

Berco can supply resin tops and modesty panels in any Benjamin Moore paint color at standard pricing. Below are samples of the most popular resin top colors used today.

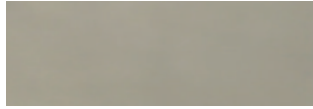

A01 Frosted White



A04 Green Cast

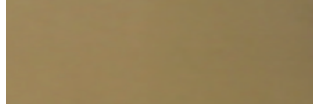

A02 Ice Cappuccino



A05 Sky Blue



A03 Crème Brulee



A06 Creamsicle

METAL CHAIRS FINISH SPECIFICATIONS

STANDARD METAL CHAIR FINISHES

Textured Finishes



T01 - Quartzite



T02 - Speckled Salt



T03 - Shubi Oxide



T04 - Dusty Ash



T05 - Black Wrinkle



T06 - Brown Wrinkle



T07 - Winter Sky



T08 - Wahelo Red

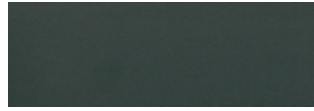

T09 - Grazor



T12 - Battleship Grey



T13 - Blue Montrose

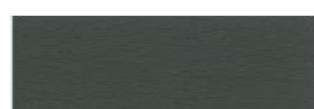

T16 - Charcoal Wrinkle



T17 - Platinum Wrinkle

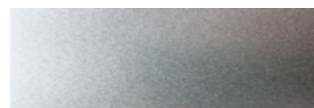

T18 - Silver Texture

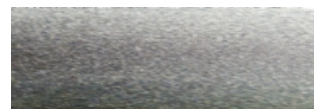

T22 - Silver Sparkle

Smooth Finishes

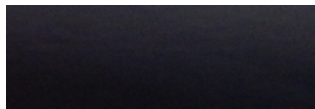

S10 - Ebony



S11 - Snow



S14 - Cappuccino



S15 - Graphite



S18 - Grey Luster



S19 - Mink



S20 - Monument Grey



S21 - Tranquil



S22 - Carmello



S23 - Jet Black



S24 - Maritime



S25 - Patriot Blue

STANDARD METAL CHAIR FINISHES

Smooth Finishes (continued)



S26 - Bonzai



S27 - Nutmeg



S28 - Dusk



S29 - Sky Grey



S30 - Bittersweet



S31 - Signature Purple



S32 - Wasabi



S43 - Brass



S44 - Industrial

Metallic Finishes

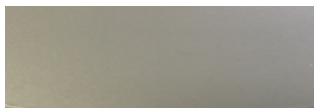

M24 - Chrometal

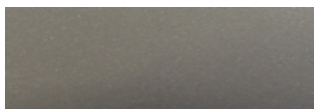

M33 - Titanium

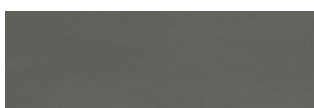

M34 - Pewter



M35 - Champagne

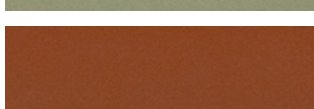

M36 - Cinnamon Sparkle

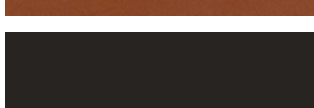

M37 - Volcanic Bronze



M38 - Gunmetal

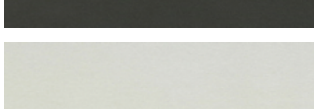

M39 - Moonlit Silver*



M40 - Oyster Pearl

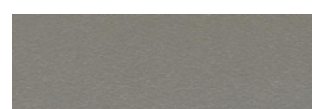

M41 - Pumice Stone

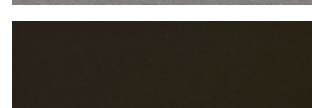

M42 - Pyrite

* Upcharge Applies

WOOD CHAIR FINISH SPECIFICATIONS

Wood Chairs & Bar Stools



Cherry

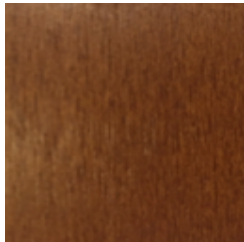

Light Cherry

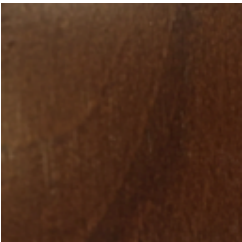

AB Cherry

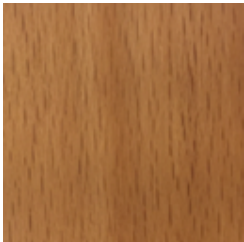

Natural

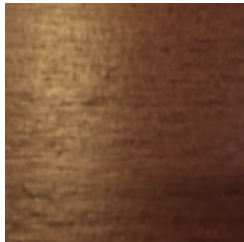

JITB

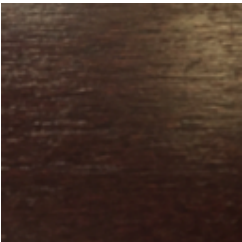

Mahogany

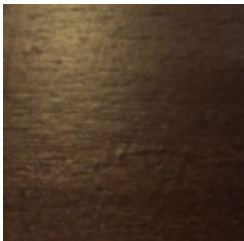

Dark Walnut

PRIVACY SCREENS FINISH SPECIFICATIONS

STANDARD COLORED ACRYLICS



Dark Blue



Light Blue



Lime Green



Moss Green



Orange



Pink



Red



Yellow Gold

ORIGINS FABRICS

	Amethyst		Indigo
	Annatto		Iron
	Arundel		Jet
	Avalon		Malt
	Bassalt		Manta
	Caraway		Mikan
	Eco		Poppy
	Eureka		Sapphire
	Euro		Sodalite
	Fez		Stately
	Gaia		Steel
	Garnet		Twine

REFERENCE INFORMATION



TOPS - WEIGHT (LBS.)

	LBS (Estimated)		Comments
	Standard	Lightweight (P12 & P14 only)	
SQUARE (SQR)			
18x18	14	10	
24x24	24	16	
30x30	37	24	
36x36	52	34	
42x42	70	45	
48x48	91	58	
54x54	114	N/A	
60x60	140	N/A	
ROUND (RND)			
18	11	8	
24	19	13	
30	29	19	
36	41	27	
42	55	35	
48	71	46	
54	90	51	
60	110	66	
72	175	97	One piece with center seam
84	213	128	Two piece with center seam
96	276	168	Two piece with center seam
RECTANGLE (REC)			
18x48	36	24	
18x60	45	29	
18x72	53	35	
18x84	62	41	
18x96	71	46	
24x30	30	20	
24x36	36	23	
24x42	41	27	
24x48	47	31	
24x60	58	38	
24x72	70	45	
24x84	81	52	
24x96	93	60	
24x120	115	N/A	3 bases
24x144	138	N/A	3 bases
30x36	44	29	
30x42	51	33	
30x48	58	37	

TOPS - WEIGHT (LBS.)

	LBS (Estimated)		Comments
	Standard	Lightweight (P12 & P14 only)	
30x60	72	46	
30x72	86	55	
30x84	100	64	
30x96	114	73	
30x120	142	N/A	3 bases
30x144	170	N/A	3 bases
36x42	61	39	
36x48	69	44	
36x60	86	55	
36x72	112	65	
36x84	119	76	
36x96	136	86	
36x120	169	N/A	3 bases
36x144	203	N/A	3 bases
42x48	80	51	
42x60	99	63	
42x72	119	75	
42x84	138	88	
42x96	157	100	
42x120	196	N/A	3 bases
42x144	235	N/A	3 bases
48x60	113	72	
48x72	135	86	
48x84	157	99	
48x96	179	113	
48x120	223	N/A	3 bases
48x144	267	N/A	3 bases
48x168	311	N/A	Two piece with center seam & c-locks
48x192	355	N/A	Two piece with center seam & c-locks
48x216	399	N/A	Two piece with center seam & c-locks
48x240	443	N/A	Two piece with center seam & c-locks
60x96	222	N/A	
60x120	277	N/A	3 bases
60x144	332	N/A	3 bases
60x168	386	N/A	Two piece with center seam & c-locks
60x192	441	N/A	Two piece with center seam & c-locks
60x216	495	N/A	Two piece with center seam & c-locks
60x240	550	N/A	Two piece with center seam & c-locks
RACETRACK (RAC)			
30x60	65	42	
36x72	93	59	

TOPS - WEIGHT (LBS.)

	LBS (Estimated)		Comments
	Standard	Lightweight (P12 & P14 only)	
36x84	109	70	
36x96	126	81	
36x120	160	N/A	3 bases
36x144	193	N/A	3 bases
42x84	125	80	
42x96	144	92	
42x120	183	N/A	3 bases
42x144	222	N/A	3 bases
48x96	161	141	
48x120	183	N/A	3 bases
48x144	250	N/A	3 bases
48x168	294	N/A	Two piece with center seam & c-locks
48x192	338	N/A	Two piece with center seam & c-locks
48x216	382	N/A	Two piece with center seam & c-locks
48x240	426	N/A	Two piece with center seam & c-locks
60x96	194	N/A	
60x120	249	N/A	3 bases
60x144	304	N/A	3 bases
60x168	359	N/A	Two piece with center seam & c-locks
60x192	413	N/A	Two piece with center seam & c-locks
60x216	468	N/A	Two piece with center seam & c-locks
60x240	523	N/A	Two piece with center seam & c-locks
BOAT (BOT)			
36x48x96	105	68	
36x48x120	157	N/A	
36x48x144	192	N/A	
42x54x120	170	N/A	
42x54x144	210	N/A	
48x60x144	226	N/A	
48x60x168	269	N/A	Two piece with center seam & c-locks
48x60x192	313	N/A	Two piece with center seam & c-locks
48x60x216	356	N/A	Two piece with center seam & c-locks
48x60x240	400	N/A	Two piece with center seam & c-locks
OVAL (OVL)			
36x60	84	45	
36x72	105	53	
36x84	110	62	
36x96	118	70	
42x72	115	61	
42x84	125	71	

TOPS - WEIGHT (LBS.)

	LBS (Estimated)		Comments
	Standard	Lightweight (P12 & P14 only)	
42x96	137	83	
48x84	142	80	
48x96	154	91	
48x120	196	N/A	3 bases
48x144	239	N/A	3 bases
60x120	238	N/A	
60x144	287	N/A	
60x168	272	N/A	Two piece with center seam
TRAPEZOID (TRP)			
24x24x48	31	21	
24x36x60	42	27	
30x30x60	48	31	
30x42x72	74	48	
36x36x72	68	44	
HALF RND (HRD)			
24x48	37	24	
30x60	57	37	
36x72	81	52	
QTR ROUND (QRD)			
24x24	19	12	
30x30	29	19	
36x36	41	26	
CRESCENT (CRT)			
24 x 24 x 48 CRT	53	34	
30 x 30 x 60 CRT	82	52	
36 x 36 x 72 CRT	118	N/A	

BASE - WEIGHT (LBS.)

		LBS (Estimated)
SENSE		
SN1-16EB	16" End	8
SN1-20EB	20" End	9
SN1-26EB	26" End	10
SNX-22	22" X	13
SNX-26	26" X	16
SNX-32	32" X	19
SNX-38	38" X	37
STARFIRE		
ST1-22EB	22" End	13
ST1-26EB	26" End	15
STX-22	22" X	17
STX-26	26" X	20
STX-32	32" X	33
STX-42	42" X	48
VOYAGER		
VS1-16EB	16" 1 Col.	13
VS1-20EB	20" 1 Col.	14
VS1-26EB	26" 1 Col.	16
VS2-16EB	16" 2 Col.	10
VS2-20EB	20" 2 Col.	11
VS2-26EB	26" 2 Col.	12
VS2-32EB	32" 2 Col.	18
VS2-38EB	38" 2 Col.	20
VS2-42EB	42" 2 Col.	22
VSX-22	22" X	13
VSX-26	26" X	16
VSX-32	32" X	18
VSX-38	38" X	33
VSX-38-5	38"-5 X	62
VSX-2226	22"x26" X	15
VSX-2638	26"x38" X	19
VSX-3238	32"x38" X	22
VSX-3838	38"x38" X	24
VOYAGER PREMIUM SOLID STEEL		
VS1BAR-16EB	16" 1 Col.	22
VS1BAR-20EB	20" 1 Col.	25
VS1BAR-26EB	26" 1 Col.	31
VS1BAR-36EB	36" 1 Col.	43
VS2BAR-36EB	36" 2 Col.	47
VS2BAR-42EB	42" 2 Col.	53

BASE - WEIGHT (LBS.)

		LBS (Estimated)
VSXBAR-20	20" X	49
VSXBAR-26	26" X	58
VSXBAR-30	30" X	71
VSXBAR-36	36" X	78
VSXBAR-36-5	36"-5 X	93
VSXBAR-2026	20"x26" X	57
VSXBAR-2630	26"x30" X	68
VSXBAR-2636	26"x36" X	74
ANYWAY		
AN1-16EB	16" End	11
AN1-23EB	23" End	12
AN1-26EB	26" End	13
AN2-32EB	32" 2 Col.	22
AN2-39EB	39" 2 Col.	25
ANX-23	23" X	16
ANX-26	26" X	17
ANX-36-3"	36"X-3" Col.	26
ANX-36-4"	36"X 4" Col.	30
MOBI		
MB1-22EB	22" End	10
MBX-22	22" X	17
MBX-28	28" X	20
MBX-32	32" X	23
TELESTO		
TLS-20EB	20" End	8
TSL-26EB	26" End	9
TITAN		
TS1-2	2" Flat Plug Leg	8
TS1-3	3" Flat Plug Leg	9
TS1-4	4" Flat Plug Leg	14
TS1-PMB	Perm. Mnt.	12
TS1-PMBE	Perm. Mnt. Elec	12
iQ PLUS		
IQS-22EB	22" End	8
VORTEX		
VOX-18X	18" - no glides	25
VOX-24X	24" - no glides	34

BASE - WEIGHT (LBS.)

		LBS (Estimated)
VOX-30X	30" - with glides	77
DISCUS		
DSX-18X	18" Stl. Spin.	29
DSX-22X	22" Stl. Spin.	44
DSX-28X	28" Stl. Spin.	80
EXCALIBUR		
ES1-16	16" 1 Col.	15
ES1-20	20" 1 Col.	17
ES1-26	26" 1 Col.	20
ES2-30	30" 2 Col.	30
ES2-36	36" 2 Col.	33
ESX-20	20" X	28
ESX-26	26" X	34
ESX-30	30" X	38
ESX-36	36" X	47
ESX-36-4	36"X-4" Col.	65
ESX-42-4	42"X-4" Col.	71
EXCALIBUR SQUARED		
ESQ1-16	16" 1 Col.	15
ESQ1-20	20" 1 Col.	17
ESQ1-26	26" 1 Col.	22
ESQ2-30	30" 2 Col.	32
ESQ2-36	36" 2 Col.	38
ESQX-20X	20" X	34
ESQX-26X	26" X	37
ESQX-30X	30" X	45
ESQX-36X	36" X	56
FLEXCALIBUR		
ESQ1-22-ADJE	22"	89
ESQ1-28-ADJE	28"	89
ESQ1-22-ADJB	22" BIFMA	89
ESQ1-28-ADJB	28" BIFMA	89
MILAN		
ML1	Single Leg	4
ML2-24	24" End Base	7
ML2-30	24" End Base	8
MLNST	Nesting Base	32

SEATING CHARTS – INDIVIDUAL TABLES

Square Tops

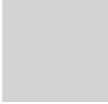

Top Size	Chairs	Wheelchairs
24" x 24"	2	
30" x 30"	2	
36" x 36"	4	
42" x 42"	4	2 (tight)
48" x 48"	4	2
60" x 60"	8	4

Round Tops



Top Size	Chairs	Wheelchairs
24" dia.	2	
30" dia.	2	
36" dia.	3	
42" dia.	4	
48" dia.	5	2

Top Size	Chairs	Wheelchairs
60" dia.	7	4
72" dia.	8	4
84" dia.	9	6
96" dia.	10	6

Rectangular Tops



Top Size	Chairs	Wheelchairs
24" x 48"	4	
30" x 48"	4	2
30" x 60"	6	4
30" x 72"	6	6
36" x 48"	6	4
36" x 60"	6	4
36" x 72"	6	6
36" x 96"	8	6

Top Size	Chairs	Wheelchairs
42" x 72"	6	4
42" x 96"	8	6
42" x 120"	10	8
48" x 72"	6	6
48" x 96"	8	6
48" x 108"	10	6
48" x 120"	10	8
48" x 144"	12	8

Racetrack, Boat and Oval Tops



Generally, these tops will accommodate the same approximate seating as the length of the table. These shapes are the most popular for conference seating and therefore length dimensions are given in feet. Widths generally vary from 30" to 60".

Top Size	Chairs	Wheelchairs
6'	6	6
8'	8	6
10'	10	8
12'	12	8
14'	14	8
16'	16	10
18'	18	10
20'	18	10
22'	20	12
24'	22	12

This is only a guide. Seating may vary according to chair design and designer's layout. Always refer to local codes.
 Seating calculation - 30" minimum per chair and 36" minimum per wheelchair.
 Cafeteria seating - minimum of 12 to 14 square feet for each seat. Office seating will vary.
 Berco recommends a minimum of 42" space between table top edges and walls.

SEATING CHARTS – TRAINING TABLES

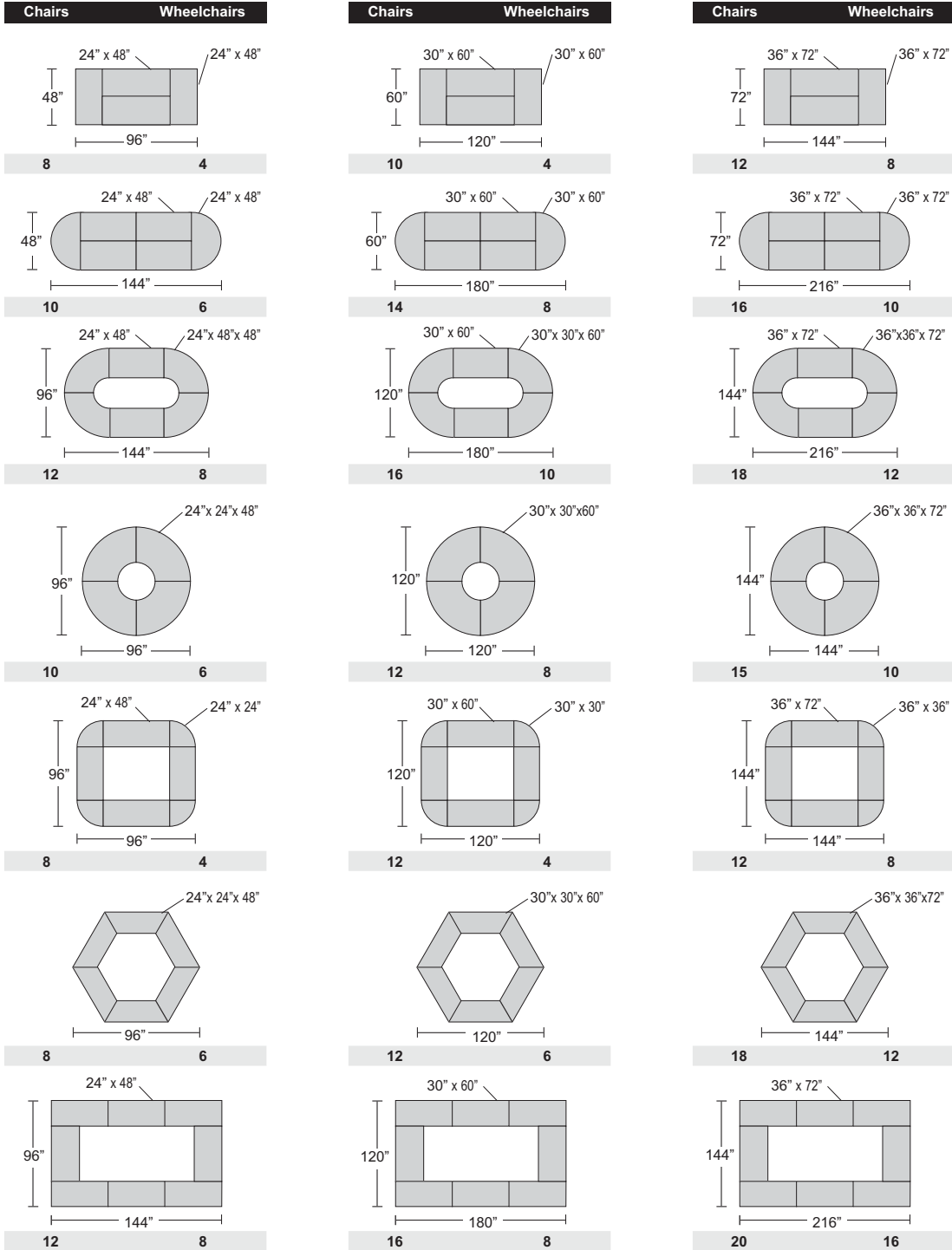

DESIGN DATA – STATIONARY PEDESTAL SPACING

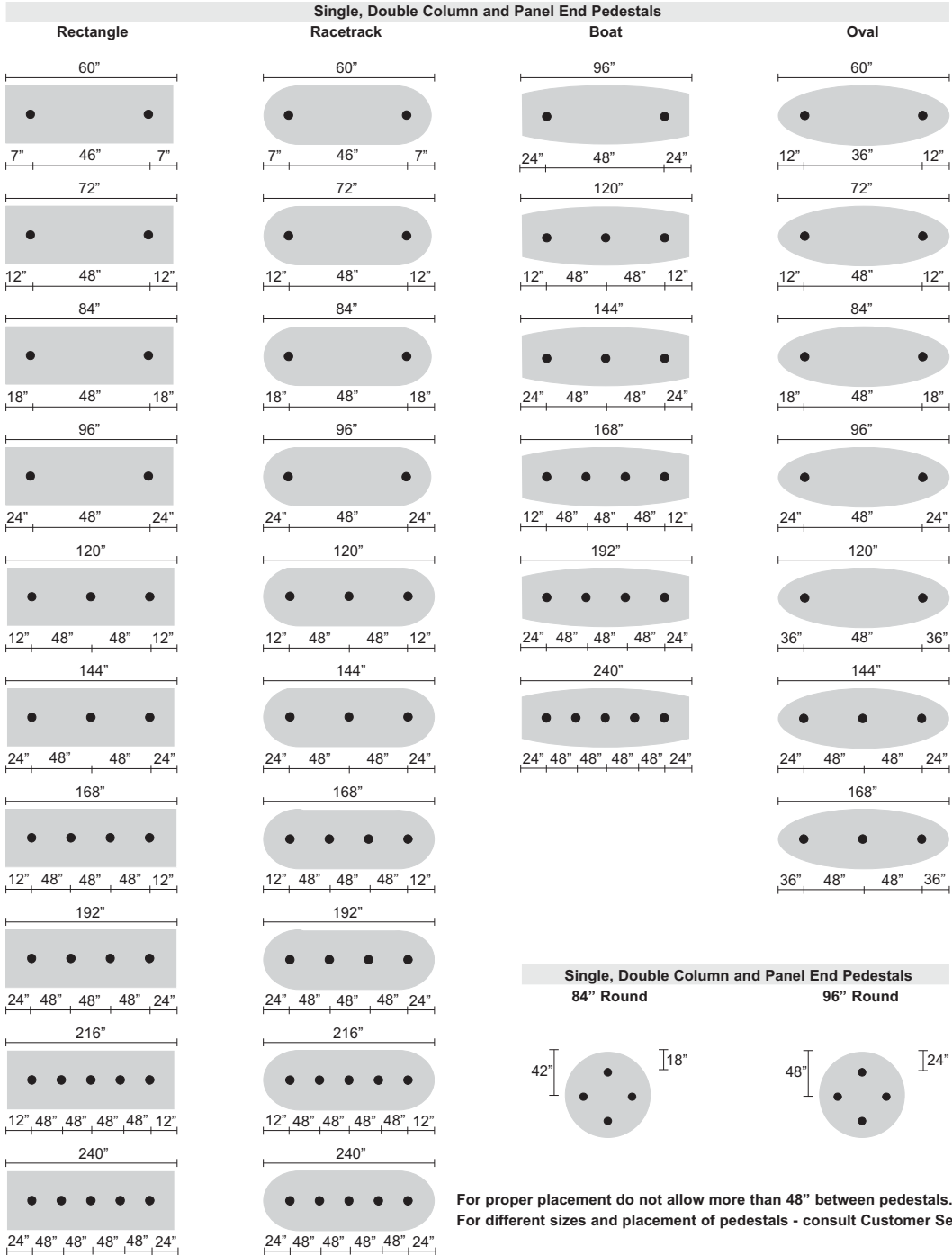

DESIGN DATA – STATIONARY PEDESTAL SPACING

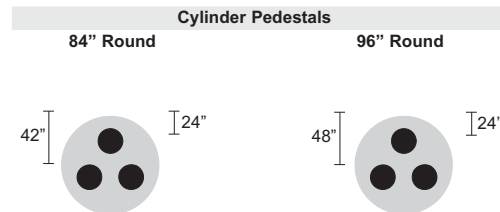
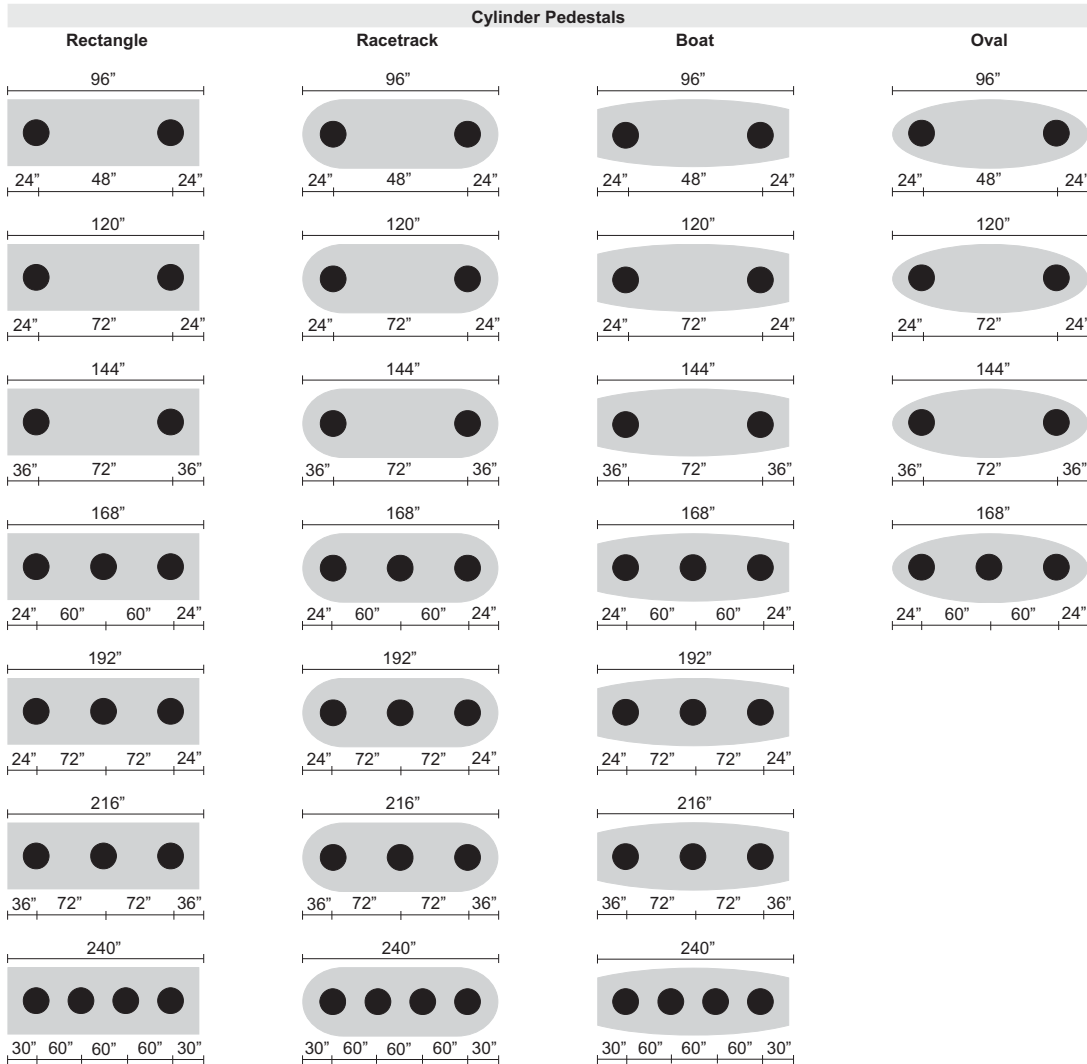

Use two half cylinders for tops up to 120" in length. For tops longer than 120" - add one or more full cylinders.
 For different size tables and placement of pedestals - consult Customer Service.

DESIGN DATA – FOLDING LEG SPACING

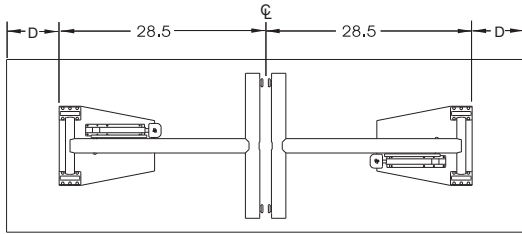

"VF" Voyager Folding Tables

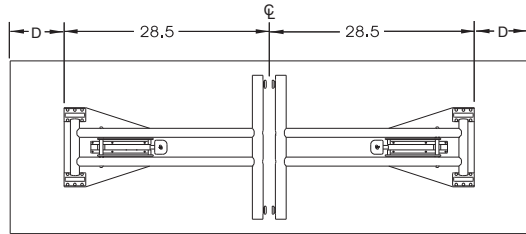

"PF" Voyager Folding Tables

Table Length	"D" Dimension
60"	1-1/2"
72"	7-1/2"
84"	13-1/2"
96"	19-1/2"

Telessto Stationary and Folding Tables

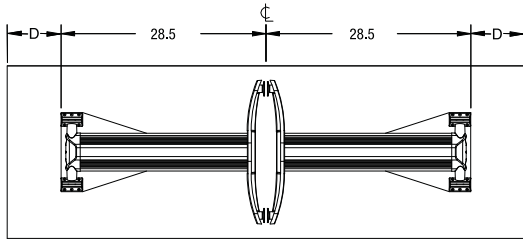

iO Plus Stationary and Folding Tables

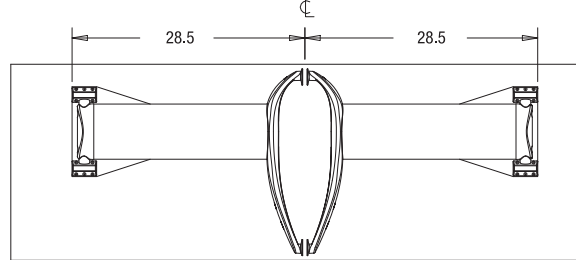

Titan Folding Tables

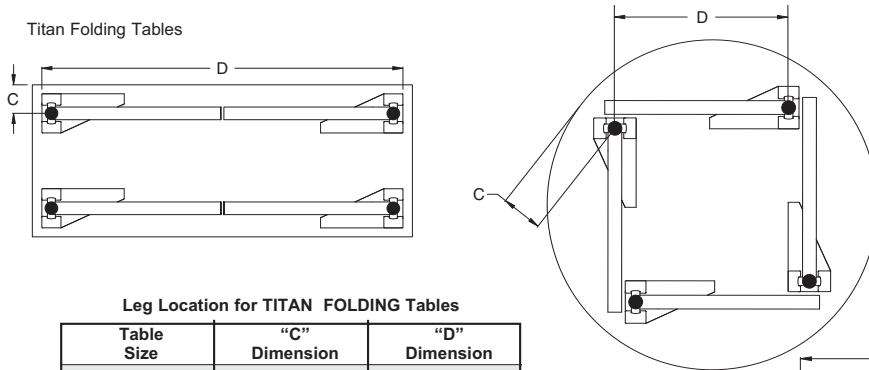

Leg Location for TITAN FOLDING Tables

Table Size	"C" Dimension	"D" Dimension
Round		
48" Dia.	6"	25.5"
60" Dia.	6"	34"
72" Dia.	12"	34"
Square		
42" Sq.	6"	30"
48" Sq.	9"	30"
60" Sq.	9"	42"
72" Sq.	12"	48"
Rectangle	60" to 96" length	
30" Wide	4.5"	57"
36" Wide	4.5"	57"
42" Wide	4.5"	57"
48" Wide	4.5"	57"

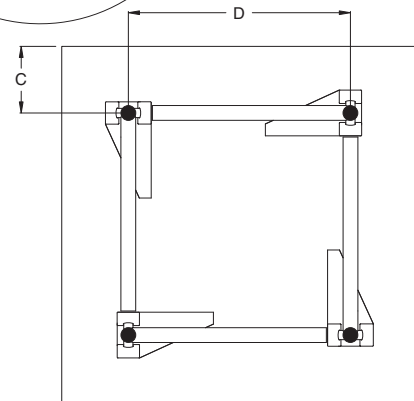

DESIGN DATA – iQ CONFERENCE LEGS

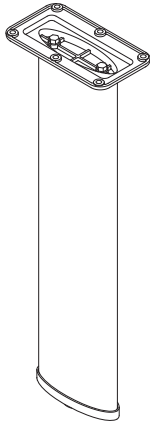

Standard Leg

2" x 6-3/4" oval, and constructed of 80% reclaimed, extruded aluminum.

Wire Management Leg

Upgraded version with 2 knockouts to route electrical and data cables through channels in the leg.

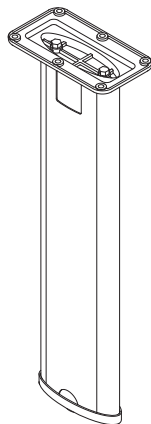
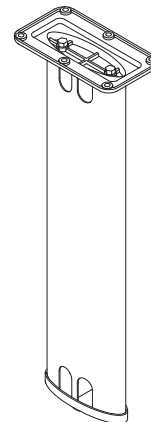

Removable Cover Leg

Optional version with a removable, black plastic insert to route electrical and data cables through the leg.

DESIGN DATA – iQ CONFERENCE PEDESTAL SPACING

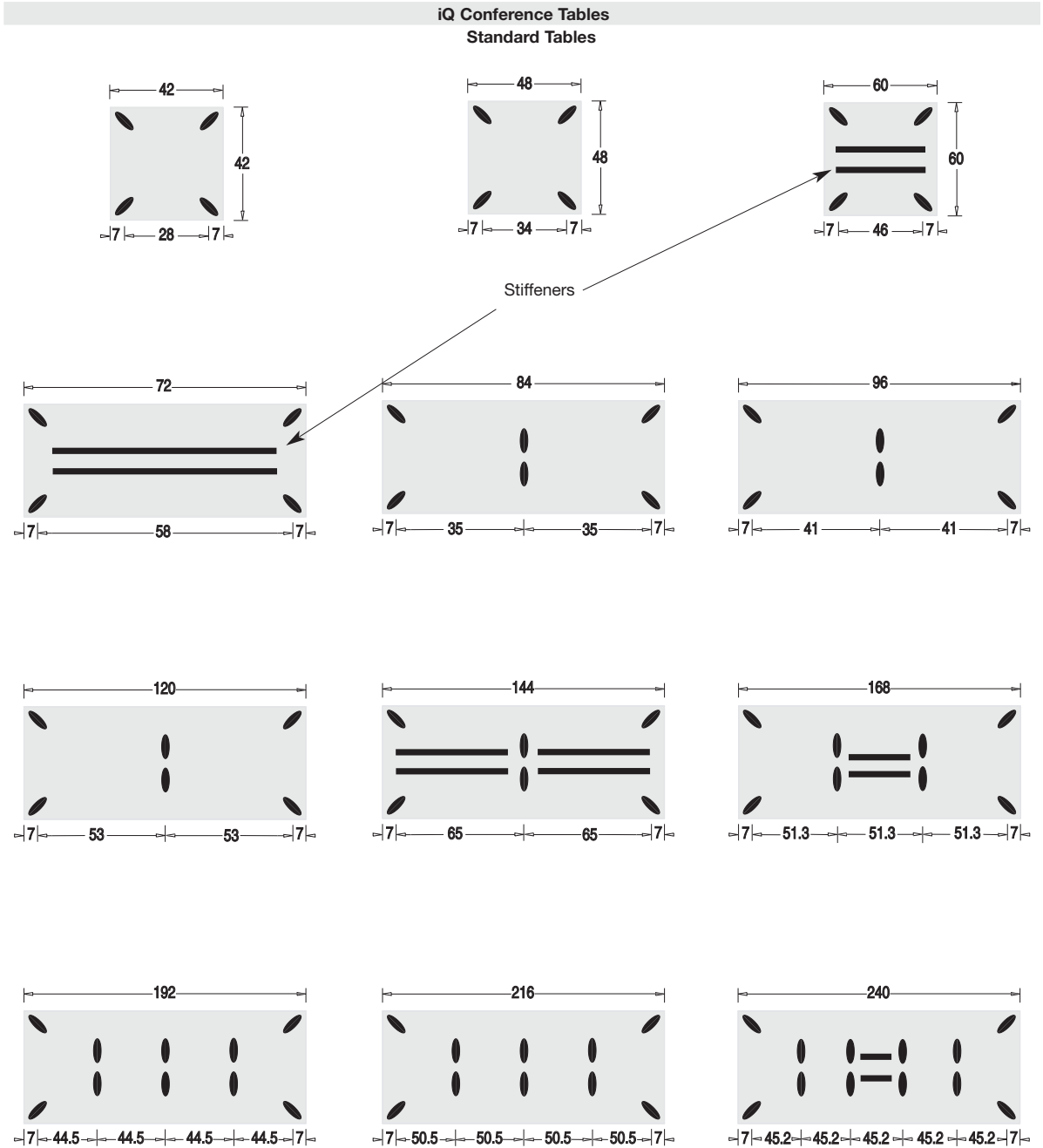

For proper placement do not allow more than 54" between pedestals.
For different sizes and placement of pedestals - consult Customer Service.

DESIGN DATA – STANDARD SHAPE TOPS

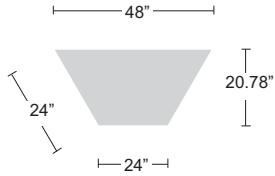

2448 Trapezoid

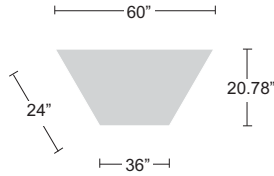

2460 Trapezoid

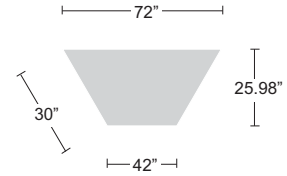

3072 Trapezoid

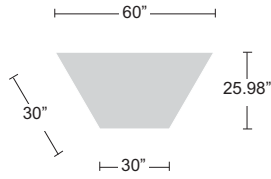

3060 Trapezoid

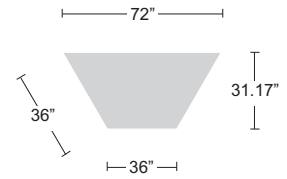

3672 Trapezoid

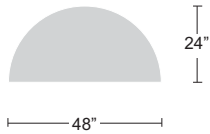

48 Half Round

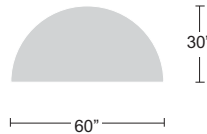

60 Half Round

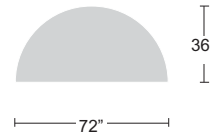

72 Half Round

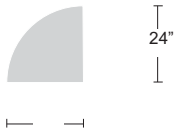

24 Quarter Round

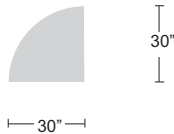

30 Quarter Round

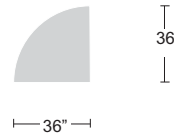

36 Quarter Round

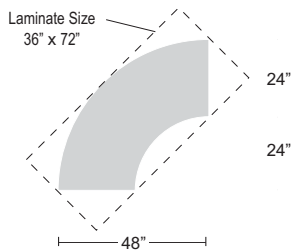

24 Crescent

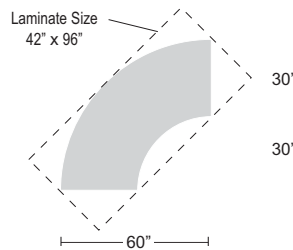

30 Crescent

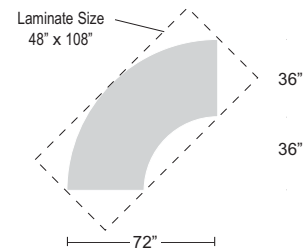

36 Crescent

For different shape tops - please provide dimensional drawings.

DESIGN DATA – NESTING

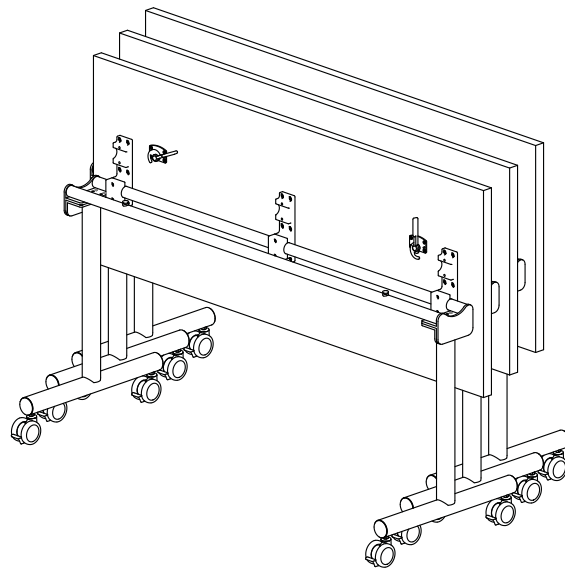
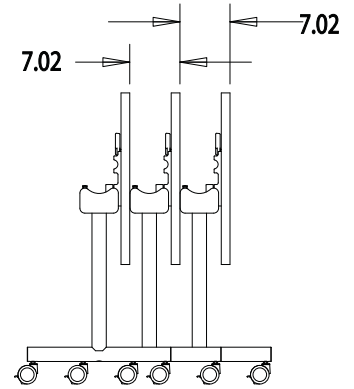
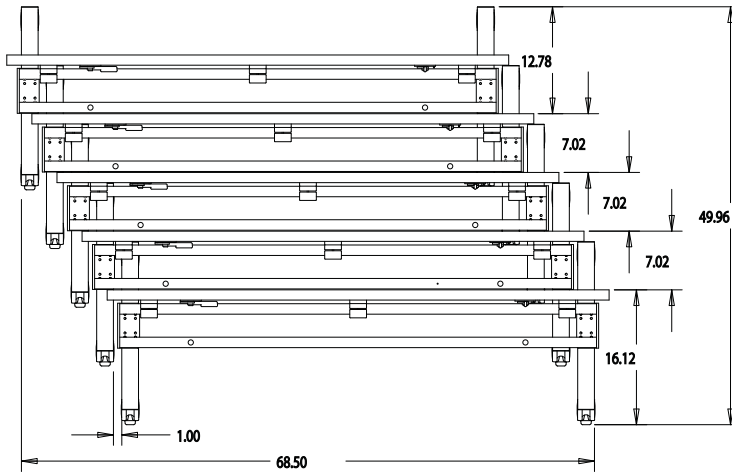



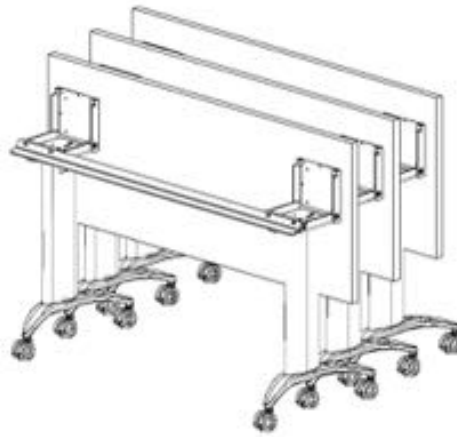
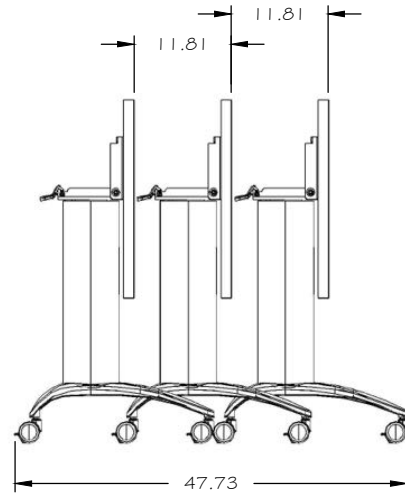
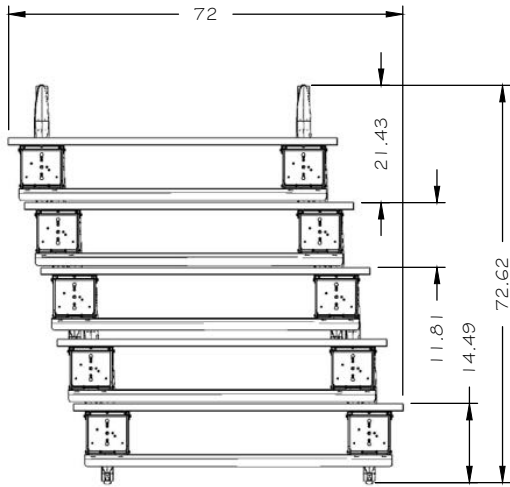

DESIGN DATA – iQ FLIP TOP



INSTALLATION INSTRUCTIONS – X BASES



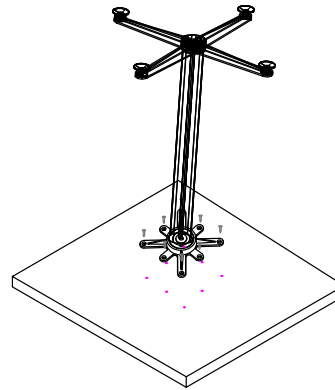

X BASE INSTALLATION INSTRUCTIONS

WOOD SCREWS (NO METAL INSERTS)		MACHINE SCREWS (METAL INSERTS)	
			
<p>QTY (6) ATTACHED TO BASE</p> <p>#10 x 1" PPH BK OXIDE PB SCREW PAN HEAD PHILLIPS</p>	<p>QTY (8) CAN BE FOUND UNDER WOOD BLOCK</p> <p>#12 x 1" PPH SCREW FLAT HEAD PHILLIPS</p> <p>SHIPPED WITH WOOD BLOCK</p>	<p>QTY (6) ATTACHED TO BASE</p> <p>1/4-20 x 5/8" PPH ZINC MACHINE SCREW PAN HEAD PHILLIPS</p>	<p>QTY (6) ATTACHED TO BASE</p> <p>1/4-20 x 1" PPH MACHINE SCREW FLAT HEAD PHILLIPS</p> <p>SHIPPED WITH WOOD BLOCK</p>

- 1) REMOVE WOOD BLOCK (IF APPLICABLE) FROM BASE
 - KEEP ALL SCREWS-(NOTE ADDITIONAL SCREWS UNDER BLOCK)
 - DISCARD WOOD BLOCK
 - IF USING MACHINE SCREWS DISCARD (4) WOOD SCREW MOUNTED TO BLOCK
- 2) PLACE TOP FACE DOWN ON CLEAN, SCRATCH FREE SURFACE
- 3) ALIGN LEG ASSEMBLY WITH PREDRILL LOCATION ON BOTTOM OF TABLE.
- 4) INSTALL SCREWS





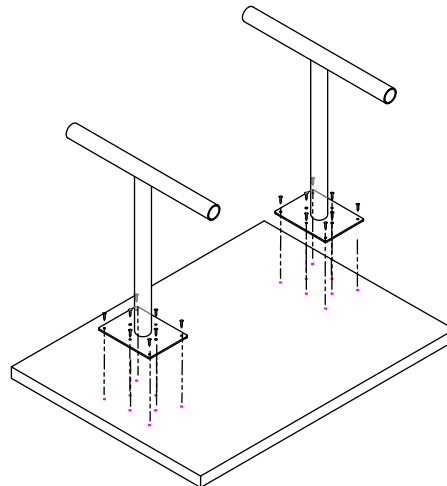

INSTALLATION INSTRUCTIONS – END BASES

WOOD SCREWS (NO METAL INSERTS)		MACHINE SCREWS (METAL INSERTS)	
			
QTY (12) PER PAIR ATTACHED TO BASE	QTY (16) PER PAIR CAN BE FOUND UNDER WOOD BLOCK	QTY (12) PER PAIR ATTACHED TO BASE	QTY (16) PER PAIR CAN BE FOUND UNDER WOOD BLOCK
#10 x 1" PAN HEAD PHILLIPS	#12 x 1" FLAT HEAD PHILLIPS	1/4-20 x 1" PAN HEAD PHILLIPS MACHINE	1/4-20 x 1" FLAT HEAD PHILLIPS MACHINE
	NOTE: WOOD BLOCK ATTACHED TO SPIDER FOR SHIPPING		NOTE: WOOD BLOCK ATTACHED TO SPIDER FOR SHIPPING

- 1) REMOVE WOOD BLOCK (IF APPLICABLE) FROM BASE
 - KEEP ALL SCREWS (NOTE ADDITIONAL SCREWS UNDER BLOCK)
 - DISCARD WOOD BLOCK
 - IF USING MACHINE SCREWS DISCARD (8) WOOD SCREWS MOUNTED TO BLOCK
- 2) PLACE TOP FACE DOWN ON CLEAN, SCRATCH FREE SURFACE
- 3) ALIGN LEG ASSEMBLY WITH PREDRILL LOCATION ON BOTTOM OF TABLE.
- 4) INSTALL SCREWS



INSTALLATION INSTRUCTIONS – iQ & TITAN BASES

WOOD SCREWS (NO METAL INSERTS)		MACHINE SCREWS (METAL INSERTS)	
			
QTY (6) ATTACHED TO BASE	QTY (6) CAN BE FOUND UNDER WOOD BLOCK	QTY (6) ATTACHED TO BASE	QTY (8) CAN BE FOUND UNDER WOOD BLOCK
#10 x 1" PAN HEAD PHILLIPS	#12 x 1" FLAT HEAD PHILLIPS	1/4-20 x 3" PAN HEAD PHILLIPS MACHINE	1/4-20 x 1" FLAT HEAD PHILLIPS MACHINE
NOTE: WOOD BLOCK ATTACHED TO SPIDER FOR SHIPPING	NOTE: WOOD BLOCK ATTACHED TO SPIDER FOR SHIPPING	NOTE: WOOD BLOCK ATTACHED TO SPIDER FOR SHIPPING	NOTE: WOOD BLOCK ATTACHED TO SPIDER FOR SHIPPING

- 1) REMOVE WOOD BLOCK (IF APPLICABLE) FROM BASE.
 - KEEP ALL SCREWS-(NOTE ADDITIONAL SCREWS UNDER BLOCK.
 - DISCARD WOOD BLOCK.
 - IF USING MACHINE SCREWS DISCARD WOOD SCREWS MOUNTED TO BLOCK.
- 2) PLACE TOP FACE DOWN ON CLEAN SCRATCH FREE SURFACE.
- 3) ALIGN LEG ASSEMBLY WITH PREDRILL LOCATION ON BOTTOM OF TABLE.
- 4) INSTALL SCREWS

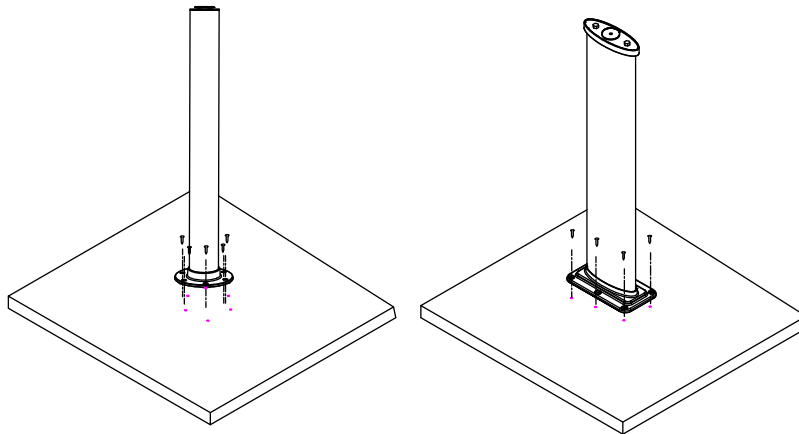

INSTALLATION INSTRUCTIONS – VOLUMA BASES

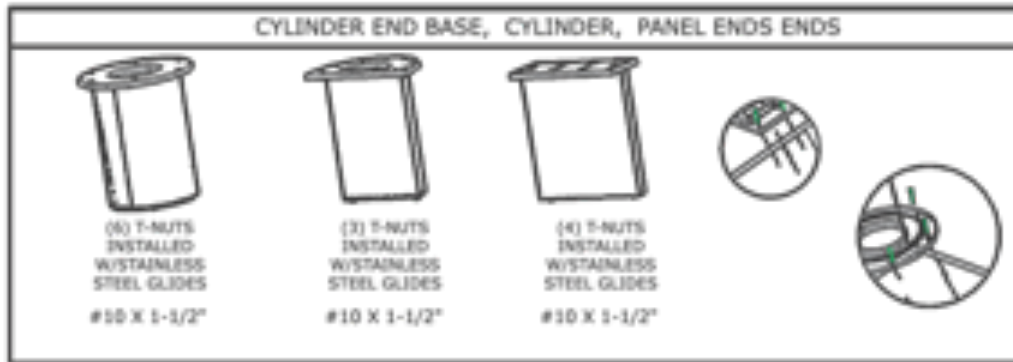

- 1) T-NUTS INSTALLED W/STAINLESS STEEL GLIDES
- 2) PLACE TABLE TOP DOWN ON CLEAN SCRATCH FREE SURFACE
- 3) ALIGN CYLINDER/PANEL ENDS WITH PREDRILL LOCATION ON BOTTOM OF TABLE
- 4) INSTALL SCREWS

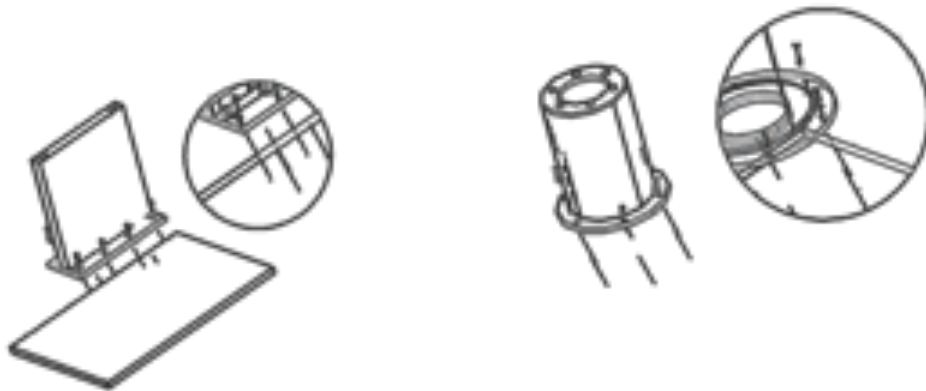

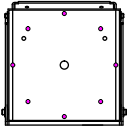
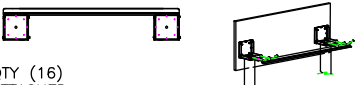

INSTALLATION INSTRUCTIONS – FLIPTOP BASES

X BASE FLIPTOP	IQ FLIPTOP W/BRIDGE
 <p style="text-align: center;">QTY (8) ATTACHED INSIDE OF FLIPTOP SPIDER #10 x 1" PAN HEAD PHILLIPS</p>	 <p style="text-align: center;">QTY (16) ATTACHED INSIDE OF FLIPTOP SPIDER #10 x 1" PAN HEAD PHILLIPS</p> <p style="text-align: center;">(4) 1/4-20 x 1/2" MACHINE SCREWS (4) FLAT WASHERS PACKED WITH BRIDGES</p>

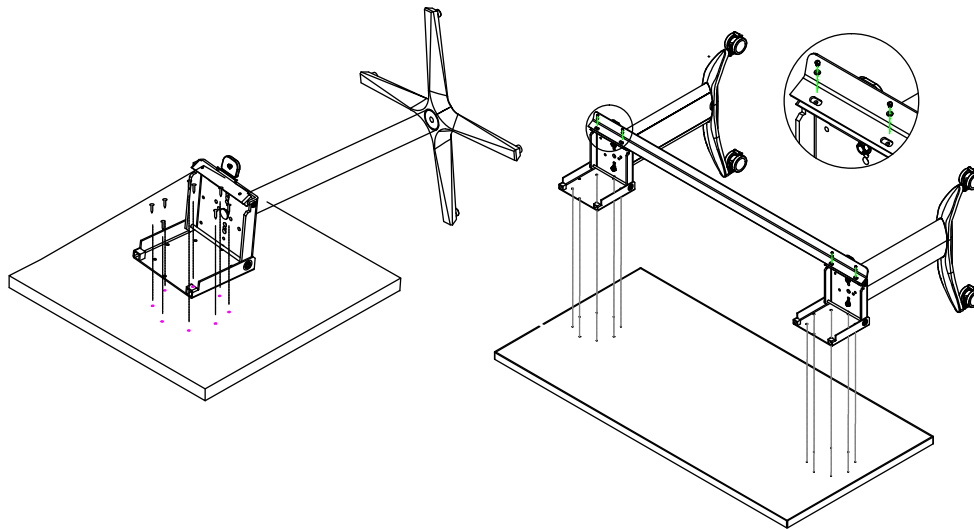
- 1) LAY TABLE FACE DOWN ON SCRATCH FREE SURFACE.
- 2) OPEN FLIPTOP SPIDERS.
- 3) ALIGN BASES TO PREDRILLED HOLES IN BOTTOM OF TABLE TOP & ATTACHED USING SCREWS PROVIDED.
- 4) ATTACH BRIDGE WHEN (APPLICABLE) TO FLIPTOP USING PROVIDED HARDWARE.

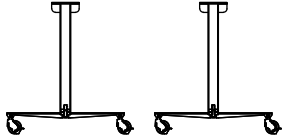

INSTALLATION INSTRUCTIONS – NESTING BASES

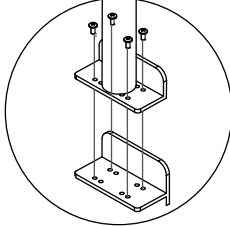
NESTING BASES	NESTING COLUMN END	NESTING INSTALL
 <p data-bbox="370 625 656 699">NESTING BASES (2) PER BOX (8) MACHINE SCREWS PER PAIR OF NESTING BASES</p>	 <p data-bbox="764 636 899 709">QTY (8) PER PAIR ATTACHED TO BASE 1/4-20 x 3/8" L PAN HEAD PHILLIPS</p>	

- 1) REMOVE NESTING BASES AND MACHINE SCREWS OUT OF CARTON
- 2) PLACE TOP FACE DOWN ON CLEAN SCRATCH FREE SURFACE
- 3) ALIGN TABLE LEG WITH THE HOLES ON PRE-INSTALLED BEAM
- 4) INSTALL MACHINE SCREW

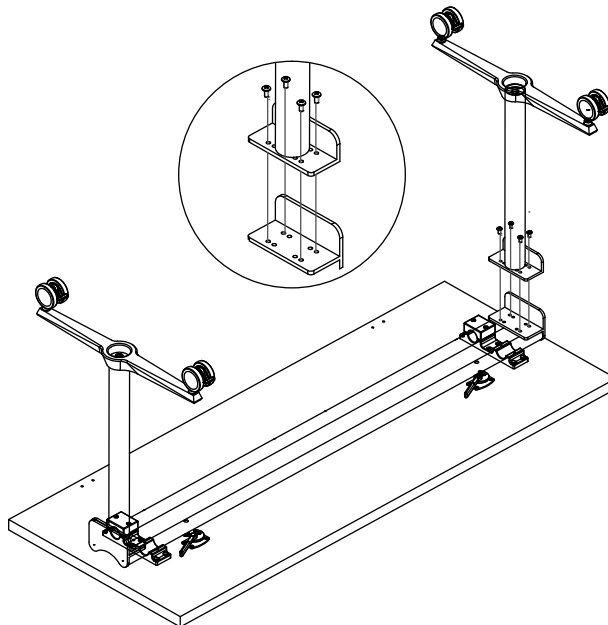



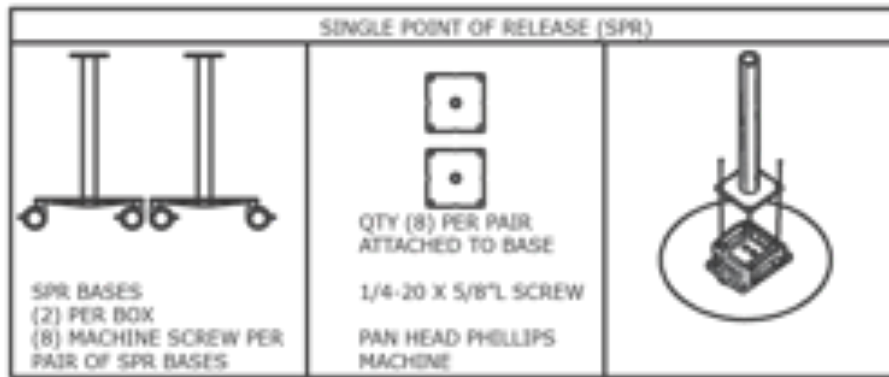



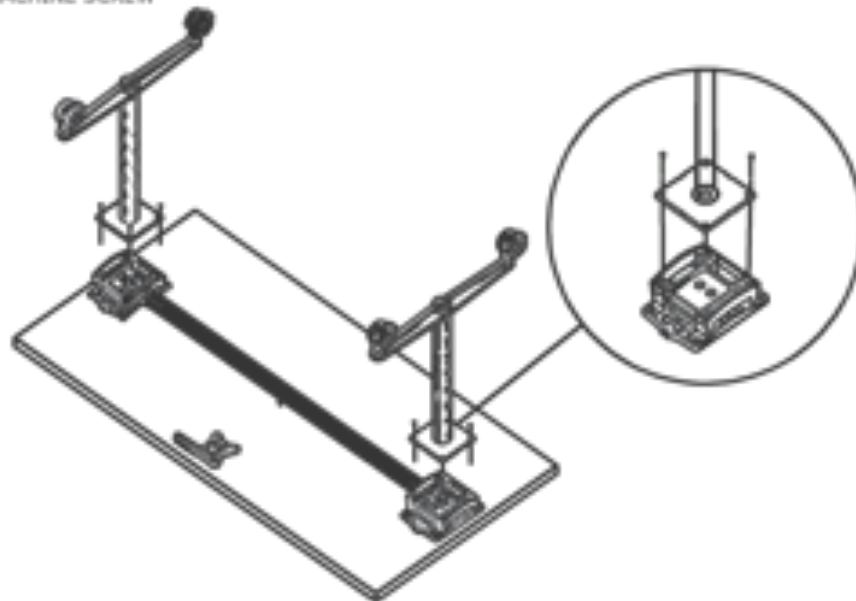



INSTALLATION INSTRUCTIONS – SINGLE POINT OF RELEASE



- 1) REMOVE SPR BASES AND MACHINE SCREWS OUT OF CARTON
- 2) PLACE TOP FACE DOWN ON, CLEAN SCRATCH FREE SURFACE
- 3) ATTACH BASE UPSIDE DOWN ON THE SINGLE POINT OF RELEASE BEAM (SPR) ALIGN (SPR) BASES WITH THE HOLE MOUNT ON BEAM
- 4) INSTALL MACHINE SCREW



INSTALLATION INSTRUCTIONS – FLOOR MOUNT/PERMANENT BASES

WOOD SCREWS (NO METAL INSERTS)		MACHINE SCREWS (METAL INSERTS)		ANCHORS FOR CONCRETE PROVIDED BY END USER
  QTY (4) CAN BE FOUND UNDER WOOD BLOCK #12 X 1" FLAT HEAD PHILLIPS <small>NOTE: WOOD BLOCK ATTACHED TO SPEAKER FOR SHIPPING</small>	  QTY (4) CAN BE FOUND UNDER WOOD BLOCK #12 X 1" FLAT HEAD PHILLIPS <small>NOTE: WOOD BLOCK ATTACHED TO SPEAKER FOR SHIPPING</small>	  QTY (6) PER PAIR CAN BE FOUND UNDER WOOD BLOCK 5/16 - 20 X 1" FLAT HEAD PHILLIPS MACHINE <small>NOTE: WOOD BLOCK ATTACHED TO SPEAKER FOR SHIPPING</small>	  QTY (6) PER PAIR CAN BE FOUND UNDER WOOD BLOCK 1/4 - 20 X 1" FLAT HEAD PHILLIPS MACHINE <small>NOTE: WOOD BLOCK ATTACHED TO SPEAKER FOR SHIPPING</small>	  <small>NOTE: CONTRACTOR TO SUPPLY CORRECT ANCHORS FOR FLOOR SURFACE</small>

- 1) REMOVE WOOD BLOCK FROM BASE
 -KEEP ALL SCREWS - (NOTE) ADDITIONAL SCREWS UNDER BLOCK
 -DISCARD WOOD BLOCK
 -IF USING MACHINE SCREWS DISCARD WOOD SCREWS MOUNTED TO WOOD BLOCK
- 2) PLACE TOP FACE DOWN ON CLEAN SCRATCH FREE SURFACE
- 3) ALIGN LEG ASSEMBLY WITH PREDRILL LOCATION ON BOTTOM OF TABLE
- 4) INSTALL SCREWS
- 5) SECURE TABLE W/BASE ATTACHED TO FLOOR WITH APPROPRIATE HARDWARE
 -NOTE: BERCO DOES NOT PROVIDE OR RECOMMEND FLOOR HARDWARE FOR FLOOR INSTALLATION, CONSULT CONTRACTOR TO SUPPLY CORRECT HARDWARE
- 6) SLIDE FLANGE COVER OVER FLOOR MOUNTED CAST

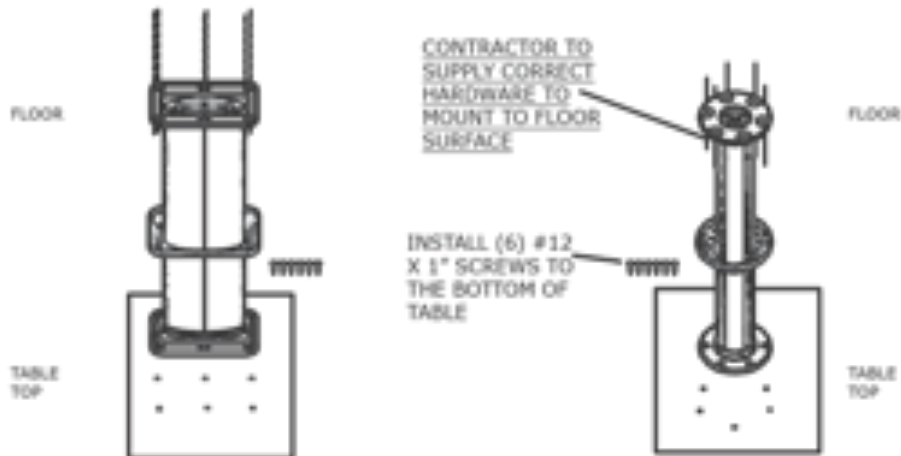

INSTALLATION INSTRUCTIONS – PIN ADJUSTABLE HEIGHT

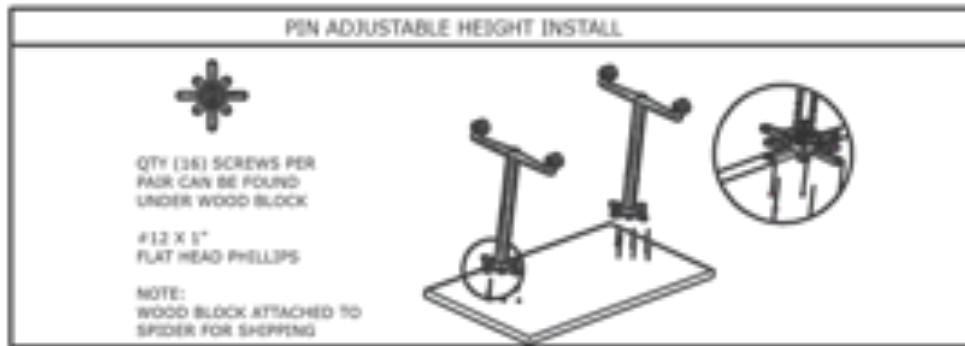

- 1) REMOVE WOOD BLOCK FROM BASE
-KEEP ALL SCREWS - (NOTE ADDITIONAL SCREWS UNDER BLOCK)
-DISCARD WOOD BLOCK
- 2) PLACE TOP FACE DOWN ON CLEAN SCRATCH FREE SURFACE
- 3) ALIGN LEG ASSEMBLY WITH PREDRILL LOCATION ON BOTTOM OF TABLE
- 4) INSTALL SCREWS

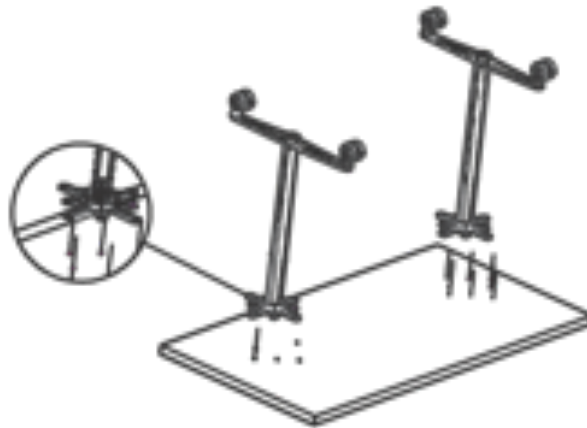

INSTALLATION INSTRUCTIONS – REMOVABLE MODESTY PANEL

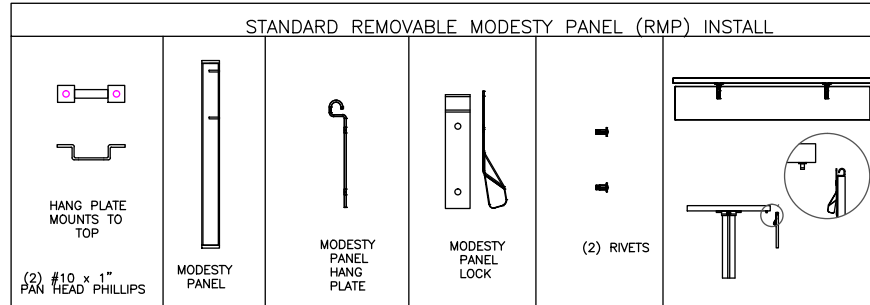

PAN HEAD PHILLIPS

- 1) HANG MODESTY PANEL ON HANG PLATE, (PREVIOUSLY INSTALLED BY BERCO)
& TWIST LOCK TO SECURE.

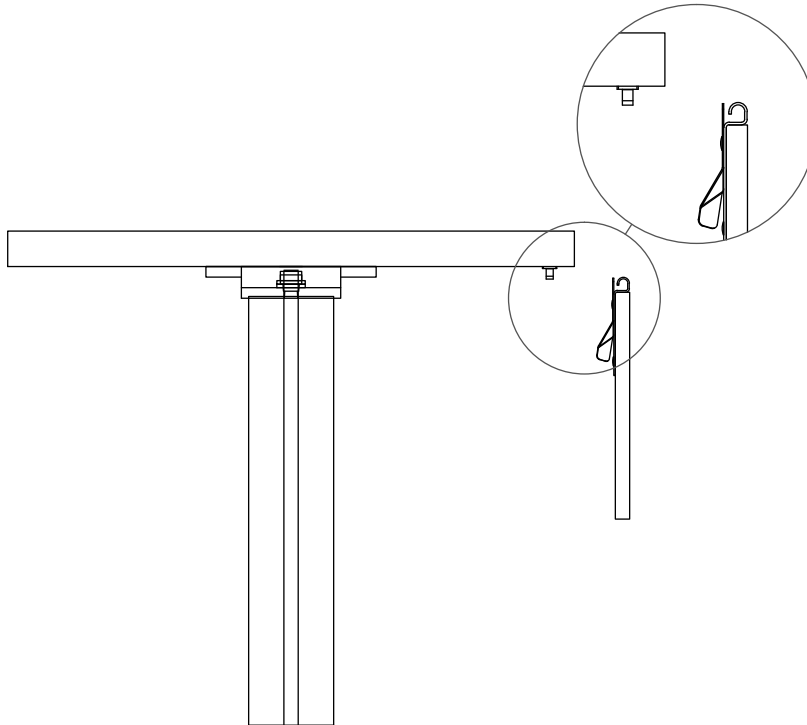

INSTALLATION INSTRUCTIONS – METAL MODESTY PANEL

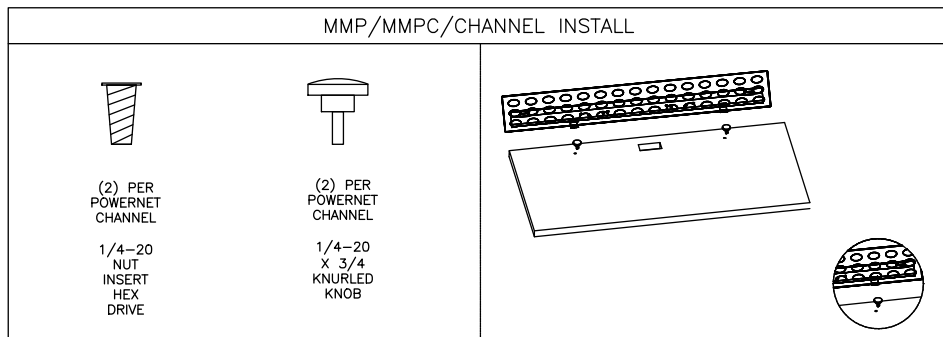

- 1) BERCO INSTALLS (2) NUT INSERTS PER TABLE TOP
- 2) INSTALL KNOBS IN TOP
- 3) LOOSEN KNOBS (DO NOT REMOVE COMPLETELY)
- 4) ALIGN MMP/MMPC/CHANNEL BRACKETS WITH KNOBS AND SLIDE INTO PLACE
- 5) LOCATE KNOBS AND TIGHTEN KNOBS SECURELY
- 6) MMP/MMPC/CHANNEL MAY BE INSTALLED WHILE THE TABLE IS UPRIGHT

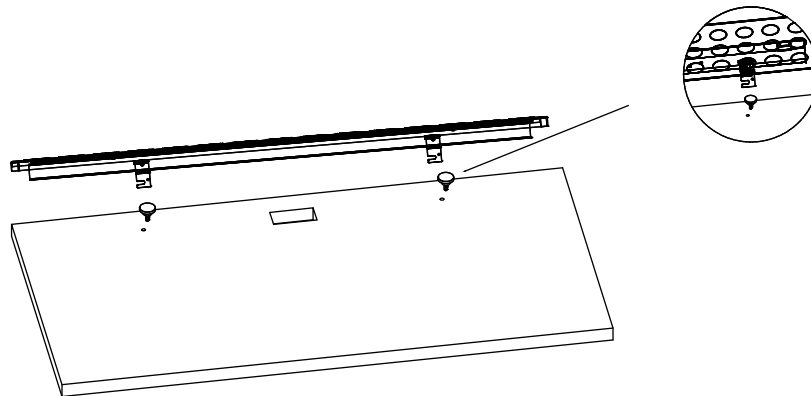
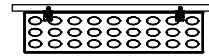

INSTALLATION INSTRUCTIONS – SLIM MODESTY PANEL

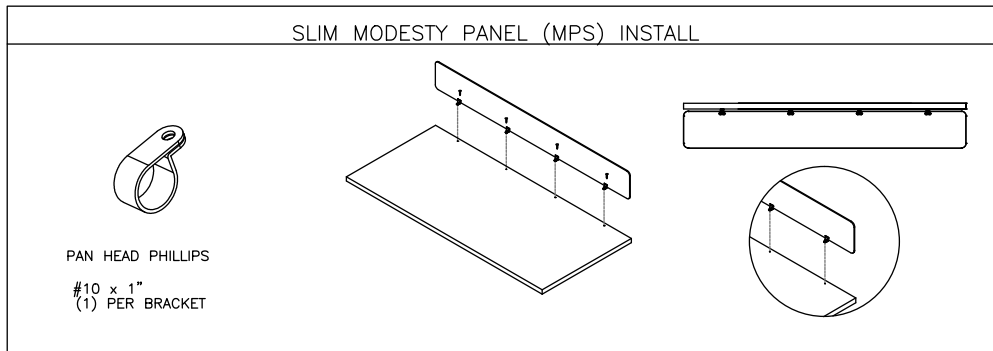

- 1) LAY TABLE TOP DOWN ON SCRATCH FREE SURFACE
- 2) ALIGN MODESTY PANEL WITH (BERCO PREDRILLED HOLES) AND HOOKS AND ATTACH THEM USING SCREWS PROVIDED.

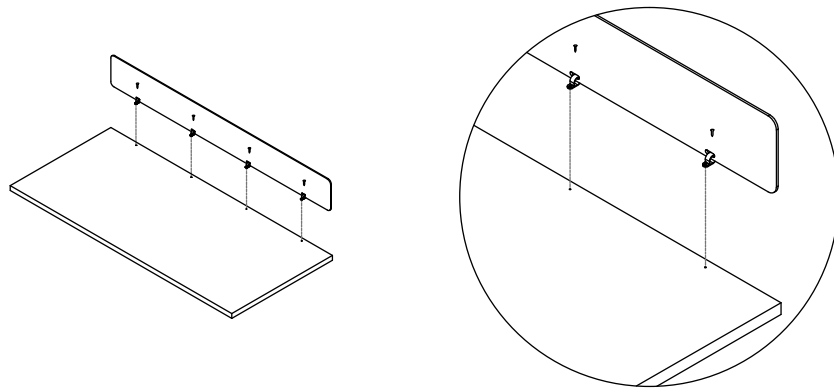

INSTALLATION INSTRUCTIONS – POWERNET

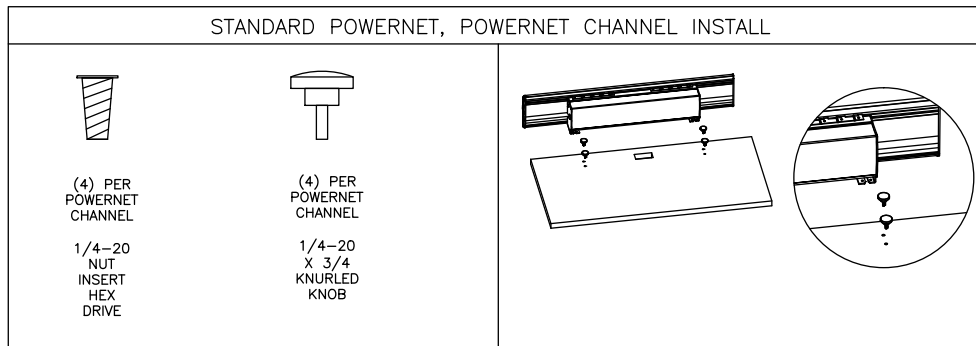

- 1) BERCO INSTALLS (4) NUT INSERTS PER TABLE TOP
- 2) LOOSEN KNOBS (DO NOT REMOVE COMPLETELY)
- 3) ALIGN POWERNET/CHANNEL BRACKETS WITH KNOBS AND SLIDE INTO PLACE
- 4) OPEN POWERNET DOOR
- 5) LOCATE KNOBS AND TIGHTEN SECURELY
- 6) POWERNET/CHANNEL SHOULD BE INSTALLED WHILE THE TABLE IS UPRIGHT

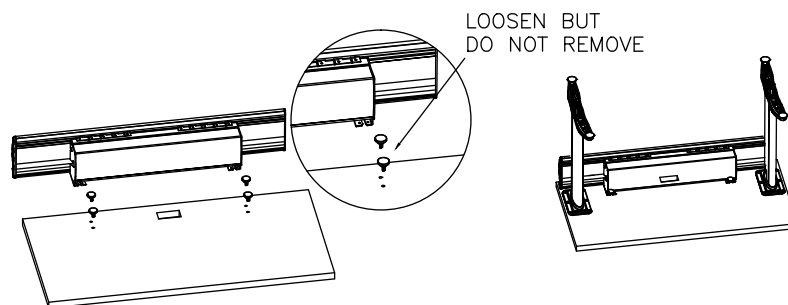

NOTES

NOTES

NOTES

NOTES

NOTES