

# CENTURY

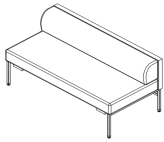
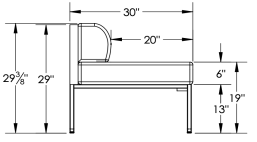
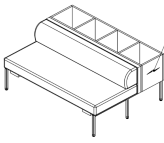
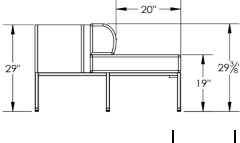
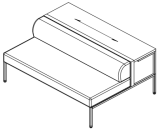
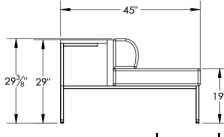
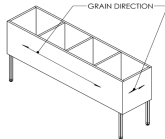
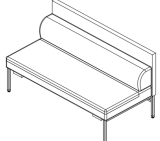
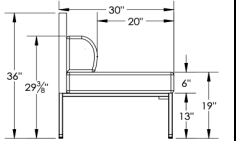
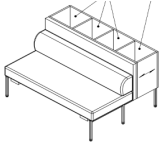
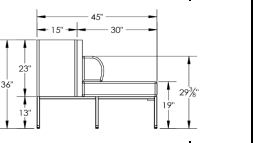
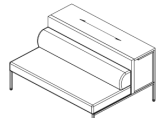
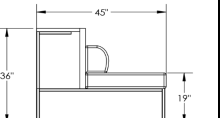

CENTURY												
		Vinyl/Fabric Grade					UPGRADES			COM YARDAGE		
Standard / COM	Grade 1	Grade 2	Grade 3	Grade 4	Grade 5	Powdercoat Upgrade ADD	Laminate Upgrade I ADD	Laminate Upgrade II ADD				
<b>LOW BACK SOFA</b>												
												
60"L x 30"D x 29"H	CENTURYSOFALOW60	\$3,699	\$4,069	\$4,439	\$4,809	\$5,364	\$5,733	\$275	N/A	N/A	8 yards	
48"L x 30"D x 29"H	CENTURYSOFALOW48	\$3,144	\$3,459	\$3,773	\$4,087	\$4,559	\$4,873	\$275	N/A	N/A	6 yards	
<b>LOW BACK SOFA &amp; PLANTER BOX</b>												
												
60"L x 45"D x 29"H	CENTURYSOFALOWPLANTER60	\$5,898	\$6,488	\$7,078	\$7,667	\$8,552	\$9,142	\$275	\$442	\$1,180	8 yards	
48"L x 45"D x 29"H	CENTURYSOFALOWPLANTER48	\$5,013	\$5,515	\$6,016	\$6,517	\$7,269	\$7,771	\$275	\$376	\$1,003	6 yards	
<b>LOW BACK SOFA &amp; LEDGE</b>												
												
60"L x 45"D x 29"H	CENTURYSOFALOWLEDGE60	\$5,308	\$5,839	\$6,370	\$6,901	\$7,697	\$8,228	\$275	\$398	\$1,062	8 yards	
48"L x 45"D x 29"H	CENTURYSOFALOWLEDGE48	\$4,512	\$4,963	\$5,414	\$5,866	\$6,542	\$6,994	\$275	\$338	\$902	6 yards	
<b>LOW STAND ALONE PLANTER BOX</b>												
												
60"L x 29"H x 15"D	CENTURYLOWPLANTER60	\$2,199	N/A	N/A	N/A	N/A	N/A	\$275	\$165	\$440	N/A	
48"L x 29"H x 15"D	CENTURYLOWPLANTER48	\$1,869	N/A	N/A	N/A	N/A	N/A	\$275	\$140	\$374	N/A	
<b>HIGH BACK SOFA</b>												
												
60"L x 30"D x 36"H	CENTURYSOFAHIGH60	\$4,439	\$4,883	\$5,327	\$5,770	\$6,436	\$6,880	\$275	N/A	N/A	10 yards	
48"L x 30"D x 36"H	CENTURYSOFAHIGH48	\$3,773	\$4,150	\$4,528	\$4,905	\$5,471	\$5,848	\$275	N/A	N/A	8 yards	
<b>HIGH BACK SOFA &amp; PLANTER BOX</b>												
												
60"L x 45"D x 36"H	CENTURYSOFAHIGHPLANTER60	\$7,078	\$7,785	\$8,493	\$9,201	\$10,263	\$10,970	\$275	\$531	\$1,416	10 yards	
48"L x 45"D x 36"H	CENTURYSOFAHIGHPLANTER48	\$6,016	\$6,618	\$7,219	\$7,821	\$8,723	\$9,325	\$275	\$451	\$1,203	8 yards	
<b>HIGH BACK SOFA &amp; LEDGE</b>												
												

**CENTURY**

Standard / COM	Vinyl/Fabric Grade					UPGRADES			COM YARDAGE
	Grade 1	Grade 2	Grade 3	Grade 4	Grade 5	Powdercoat Upgrade	Laminate Upgrade I	Laminate Upgrade II	
	ADD	ADD	ADD	ADD	ADD	ADD	ADD	ADD	

60"L x 45"D x 36"H CENTURYSOFAHIGHLEDGE60  
 48"L x 45"D x 36"H CENTURYSOFAHIGHLEDGE48

\$6,370	\$7,007	\$7,644	\$8,281	\$9,236	\$9,873	\$275	\$478	\$1,274	10 yards
\$5,414	\$5,956	\$6,497	\$7,039	\$7,851	\$8,392	\$275	\$406	\$1,083	8 yards

**HIGH BACK CORNER SOFA & MILLWORK  
 SHORT END LEFT AS SEATED**

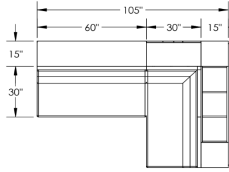
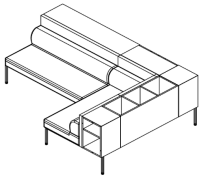

105"L x 75"D x 36"H CENTURYSOFALEFTCORNER10575  
 105"L x 60"D x 36"H CENTURYSOFALEFTCORNER10560

\$22,830	\$25,113	\$27,396	\$29,679	\$33,104	\$35,387	\$400	\$856	\$2,283	17 yards
\$20,547	\$22,602	\$24,656	\$26,711	\$29,793	\$31,848	\$400	\$771	\$2,055	14 yards

**HIGH BACK CORNER SOFA & MILLWORK  
 SHORT END RIGHT AS SEATED**

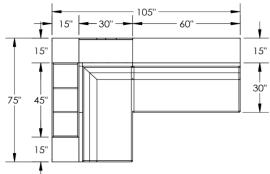
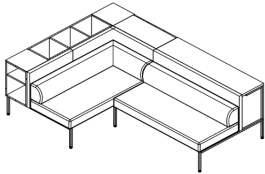

105"L x 75"D x 36"H CENTURYSOFARIGHTCORNER10575  
 105"L x 60"D x 36"H CENTURYSOFARIGHTCORNER10560

\$22,830	\$25,113	\$27,396	\$29,679	\$33,104	\$35,387	\$400	\$856	\$2,283	17 yards
\$20,547	\$22,602	\$24,656	\$26,711	\$29,793	\$31,848	\$400	\$771	\$2,055	14 yards

**HIGH BACK CORNER SOFA (NO MILLWORK)**

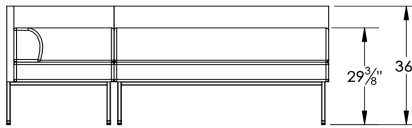
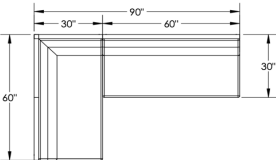
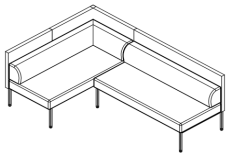

Short End Right As Seated  
 90"L x 60"D x 36"H CENTURYSOFAONLYRIGHTCORNER9060  
 90"L x 48"D x 36"H CENTURYSOFAONLYRIGHTCORNER9060

\$10,380	\$11,418	\$12,456	\$13,494	\$15,051	\$16,089	\$400	N/A	N/A	17 yards
\$9,342	\$10,276	\$11,210	\$12,145	\$13,546	\$14,480	\$400	N/A	N/A	14 yards

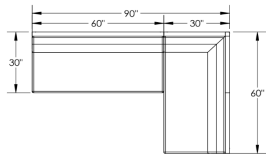
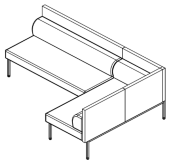

Short End Left As Seated  
 90"L x 60"D x 36"H CENTURYSOFAONLYLEFTCORNER9060  
 90"L x 48"D x 36"H CENTURYSOFAONLYLEFTCORNER9060

\$10,380	\$11,418	\$12,456	\$13,494	\$15,051	\$16,089	\$400	N/A	N/A	17 yards
\$9,342	\$10,276	\$11,210	\$12,145	\$13,546	\$14,480	\$400	N/A	N/A	14 yards

**HIGH STAND ALONE PLANTER BOX**

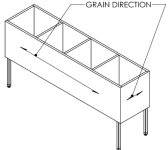

60"L x 15"D x 36"H CENTURYHIGHPLANTER60  
 48"L x 15"D x 36"H CENTURYHIGHPLANTER48

\$2,419	N/A	N/A	N/A	N/A	N/A	\$275	\$181	\$484	N/A
\$2,056	N/A	N/A	N/A	N/A	N/A	\$275	\$154	\$411	N/A

**SOFT SEATING SECTIONS**

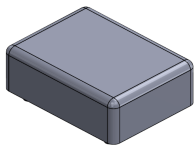

**CENTURY**

36"L x 36"W x 15"H    CENTURYSOFT363615  
 36"L x 27"W x 15"H    CENTURYSOFT362715

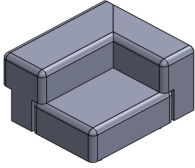

45"L x 40-1/2"W x 28"H    CENTURYSOFTCORNER454028

**CENTURY DISCUS TABLE**

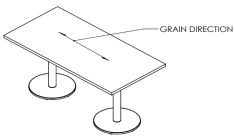

60"L x 30"W x 29"H    CENTURYDISCUS306029    \$1,930  
 48"L x 30"W x 29"H    CENTURYDISCUS304829    \$1,641  
 60"L x 30"W x 36"H    CENTURYDISCUS306036    \$2,123  
 48"L x 30"W x 36"H    CENTURYDISCUS304836    \$1,805

**CENTURY ROLLING TABLE**

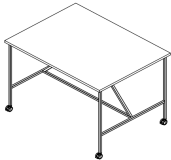

60"L x 45"W x 42"H    CENTURYROLLTABLE604542    \$3,067  
 60"L x 45"W x 36"H    CENTURYROLLTABLE604536    \$2,914  
 48"L x 30"W x 42"H    CENTURYROLLTABLE483042    \$2,760  
 48"L x 30"W x 36"H    CENTURYROLLTABLE483036    \$2,622

**CENTURY STATIONARY TABLE**

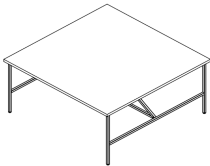

60"L x 60"W x 36"H    CENTURYSTATABLE606036    \$7,199  
 60"L x 60"W x 29"H    CENTURYSTATABLE606029    \$6,839  
 60"L x 48"W x 36"H    CENTURYSTATABLE604836    \$6,119  
 60"L x 48"W x 29"H    CENTURYSTATABLE604829    \$5,813  
 120"L x 60"W x 36"H    CENTURYSTATABLE1206036    \$14,398  
 120"L x 60"W x 29"H    CENTURYSTATABLE1206029    \$13,678  
 120"L x 48"W x 36"H    CENTURYSTATABLE1204836    \$12,238  
 120"L x 48"W x 29"H    CENTURYSTATABLE1204829    \$11,626

**CENTURY NESTING TABLE**

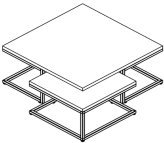

36"L x 36"W x 16"H    CENTURYNEST363616    \$1,788  
 24"L x 24"W x 14"H    CENTURYNEST242414    \$1,192

**CENTURY LAPTOP TABLE**

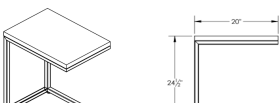

Standard / COM	Vinyl/Fabric Grade					UPGRADES			COM YARDAGE	
	Grade 1	Grade 2	Grade 3	Grade 4	Grade 5	Powdercoat Upgrade	Laminate Upgrade I	Laminate Upgrade II		
						ADD	ADD	ADD		
	\$1,470	\$1,617	\$1,764	\$1,911	\$2,132	\$2,279	N/A	N/A	N/A	
	\$1,270	\$1,397	\$1,524	\$1,651	\$1,842	\$1,969	N/A	N/A	N/A	
	\$4,220	\$4,642	\$5,064	\$5,486	\$6,119	\$6,541	N/A	N/A	N/A	
	\$1,930	N/A	N/A	N/A	N/A	N/A	\$275	\$145	\$386	N/A
	\$1,641	N/A	N/A	N/A	N/A	N/A	\$275	\$123	\$328	N/A
	\$2,123	N/A	N/A	N/A	N/A	N/A	\$275	\$159	\$425	N/A
	\$1,805	N/A	N/A	N/A	N/A	N/A	\$275	\$135	\$361	N/A
	\$3,067	N/A	N/A	N/A	N/A	N/A	\$275	\$230	\$613	N/A
	\$2,914	N/A	N/A	N/A	N/A	N/A	\$275	\$219	\$583	N/A
	\$2,760	N/A	N/A	N/A	N/A	N/A	\$275	\$207	\$552	N/A
	\$2,622	N/A	N/A	N/A	N/A	N/A	\$275	\$197	\$524	N/A
	\$7,199	N/A	N/A	N/A	N/A	N/A	\$275	\$540	\$1,440	N/A
	\$6,839	N/A	N/A	N/A	N/A	N/A	\$275	\$513	\$1,368	N/A
	\$6,119	N/A	N/A	N/A	N/A	N/A	\$275	\$459	\$1,224	N/A
	\$5,813	N/A	N/A	N/A	N/A	N/A	\$275	\$436	\$1,163	N/A
	\$14,398	N/A	N/A	N/A	N/A	N/A	\$275	\$1,080	\$2,880	N/A
	\$13,678	N/A	N/A	N/A	N/A	N/A	\$275	\$1,026	\$2,736	N/A
	\$12,238	N/A	N/A	N/A	N/A	N/A	\$275	\$918	\$2,448	N/A
	\$11,626	N/A	N/A	N/A	N/A	N/A	\$275	\$872	\$2,325	N/A
	\$1,788	N/A	N/A	N/A	N/A	N/A	\$275	\$134	\$358	N/A
	\$1,192	N/A	N/A	N/A	N/A	N/A	\$275	\$89	\$238	N/A

# CENTURY

Standard / COM	Vinyl/Fabric Grade					UPGRADES			COM YARDAGE
	Grade 1	Grade 2	Grade 3	Grade 4	Grade 5	Powdercoat Upgrade	Laminate Upgrade I	Laminate Upgrade II	
						ADD	ADD	ADD	



20"L x 14"W x 24-1/2"H CENTURYLAPTOPTABLE

### ASHLEY UNDERMOUNT 1 POWER & 2 USB

Black - 6' Corded  
Black - 10' Corded

### PRE-CONFIGURED OPTIONS

**LAYOUT A** Includes 12 Power Units \$53,669

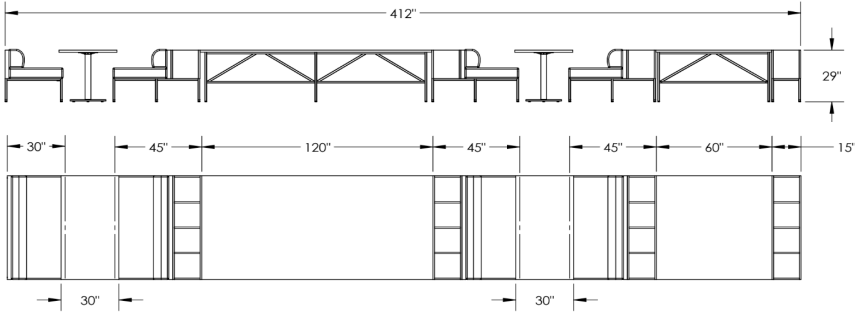

**LAYOUT B** \$15,341

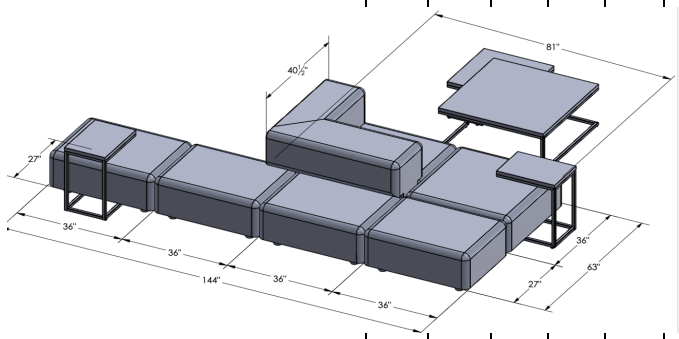

**LAYOUT C** Includes 8 Power Units \$46,536

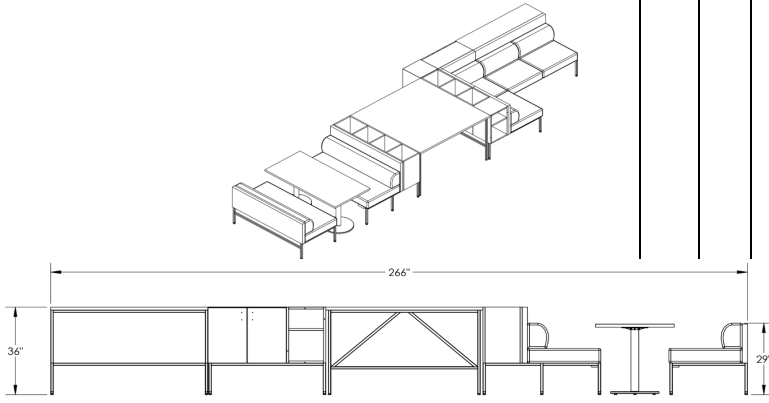

**LAYOUT D** Includes 8 Power Units \$24,264

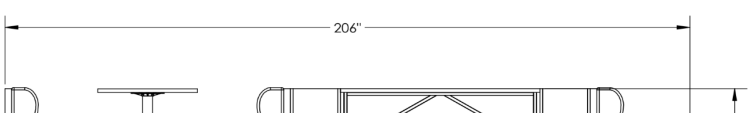

**CENTURY**

Vinyl/Fabric Grade						UPGRADES			COM YARDAGE
Standard / COM	Grade 1	Grade 2	Grade 3	Grade 4	Grade 5	Powdercoat Upgrade	Laminate Upgrade I	Laminate Upgrade II	
ADD	ADD	ADD	ADD	ADD	ADD	ADD	ADD	ADD	

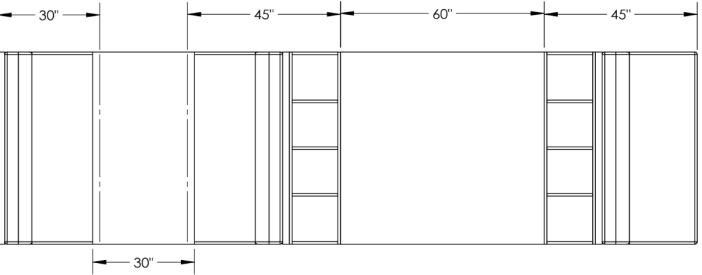
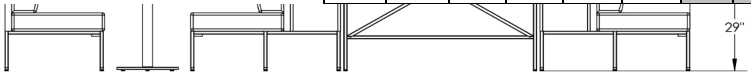

**LAYOUT E**

Includes 4 Power Units

\$21,136

